





# AWNINGS / AWNING TENTS

## Awnings - Sunblocker

Made from high-quality mesh fabric



### Awnings - Sunblocker SAONA

- With eyelets for tensioning
- high-quality mesh fabric
- Incl. Pannier

**Front panel** With double piping for awnings, multirail etc. With clips for rolling up. Material: Mesh fabric (mesh/PVC), double piping Ø: 5+7 mm, pegs, guy ropes and packing bag included.

W 240 x H 190 cm	<b>44812</b>	<b>79,95</b>
W 280 x H 190 cm	<b>44813</b>	<b>89,95</b>
W 330 x H 190 cm	<b>44814</b>	<b>99,95</b>
W 380 x H 190 cm	<b>44815</b>	<b>109,95</b>
W 430 x H 190 cm	<b>44816</b>	<b>119,95</b>

#### Side panel

For awnings with 250cm extension. Fixation with tension rod (must be ordered separately with adapter for awning). With clips for rolling up. Material: mesh fabric (mesh/PVC), pegs, guy ropes and packing bag included.

Width 250 cm, H 190 cm	<b>44817</b>	<b>69,95</b>
------------------------	--------------	--------------

**Further information:** See page 129

Reimo Tent Technology awning canopy.....	126 – 127	Info Thule awnings.....	163
Reimo Tent Technology awning accessories.....	128 – 129	Thule roof awning & adapter.....	164 – 167
Info awning adapter.....	130 – 132	Thule wall awning for motorhomes.....	168 – 169
Info Fiamma awnings.....	133	Thule awning for buses & vans.....	170 – 171
Fiamma roof awnings & adapters.....	134 – 139	Thule adapter for wall awnings.....	172 – 174
Fiamma awning canopies, roof awnings.....	139 – 141	Thule caravan awnings.....	175
Fiamma wall awnings & adapters.....	142 – 145	Thule Subsola triangular panel.....	175
Fiamma awning canopies, wall awnings.....	146 – 148	Thule Blocker.....	176 – 177
Fiamma awnings VW, buses & vans.....	149 – 152	Thule awnings.....	178 – 180
Fiamma awnings minivans & adapters.....	152 – 153	Thule Accessories & Spare Parts.....	181 – 182
Fiamma Minicamper awnings.....	154	Dometic awnings & accessories.....	183
Fiamma front and side panels.....	155 – 157	Rafters, storm locks & accessories.....	184 – 187
Fiamma caravan awnings.....	158 – 159	Awning lighting.....	188 – 189
Fiamma accessories & spare parts.....	160 – 162		

# AWNINGBLINDS FOR FIAMMA CARAVANSTORE

Especially for FIAMMA Caravanstore bag awning



Caravan awning "Caravanstore" see page 158

## Villa Store Caravan SET



Front and side parts for FIAMMA caravan door incl. all curtains as Complete set. Existing consisting of 1 front section, 2 side sections and curtains for Fiamma caravan doors.

### Front parts Villa Store Caravan Front

Front parts for FIAMMA caravan gate incl. window.

**Side parts Villa Store Caravan Side** Side parts for FIAMMA caravan door left and right. Incl. Windows. With 2 aluminum rods Ø 25/28 mm for upper attachment of side panels.

**Scope of delivery** 1 x front section, 2 x side sections, curtains, pack sack, ladder tensioning elements & pegs.

### Material

210 D Oxford Polyester. Water column: 1000 mm.

### Accessories

Pressure bar set with foam bead with Velcro, W 10 x L 219 x D 4 cm. Mounted between the side wall and caravan for windproof connection. With telescopic steel bars.

Material: 190 T polyester, weight: 3.0 kg.

**475644 51,95**

## Villa Store caravan front and side panels for FIAMMA caravan door



Villa Store XL



Villa Store

### Villa Store XL Caravan SET - complete set of front part, side part & curtains

Type	for FIAMMA	Width (B)	Height (H)	Depth (T)	Weight	Art. no.	Price
Villa Caravan XL335	Caravan Store 360 XL	335 cm	210 cm	240 cm	11,4 kg	47572	329,-
Villa Caravan XL385	Caravan Store 410 XL	385 cm	210 cm	240 cm	11,9 kg	47573	339,-
Villa Caravan XL415	Caravan Store 440 XL	415 cm	210 cm	240 cm	12,5 kg	47574	369,-

### Villa Store Caravan SET - complete set of front part, side part & curtains

Type	for FIAMMA	Width (B)	Height (H)	Depth (T)	Weight	Item no.	Price
Villa Caravan 285	Caravan Store 310	285 cm	210 cm	215 cm	10,0 kg	47567	205,-
Villa Caravan 335	Caravan Store 360	335 cm	210 cm	215 cm	10,4 kg	47568	212,-
Villa Caravan 385	Caravan Store 410	385 cm	210 cm	215 cm	10,9 kg	47569	219,-
Villa Caravan 415	Caravan Store 440	415 cm	210 cm	215 cm	11,5 kg	47570	227,-

### Villa Store Caravan Front - front part

Type	for FIAMMA	Width (B)	Height (H)	Weight	Art. no.	Price
Villa Caravan 335	Caravan Store 360	335 cm	210 cm	3,3 kg	47564	54,99
Villa Caravan 415	Caravan Store 440	415 cm	210 cm	3,5 kg	47566	59,99

### Curtain set for villa caravan front

Color	Weight	Art. no.	Price
White	0,57 kg	475643	17,50

### COLOR COMBINATION VILLA STORE XL



### COLOR COMBINATION VILLA STORE



### INFO

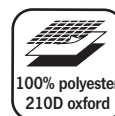





**Villa Toulouse Caravan set for caravan awning  
Thule Omnistor 1200**

Front and side parts for THULE caravan awning 1200 in case. Complete set incl. curtains consisting of 1x front part and 2x side parts.

**Front part Villa Toulouse Caravan**

The front covers the entire width of awning, has a large, transparent PVC window and a door that can be rolled up to the side. The window has curtains with a modern print.

**Villa Toulouse Caravan side sections**

The two side sections each have a transparent PVC window, also with printed curtains. The side sections are attached to the awning with the corresponding tension rods

**Scope of delivery**

1 x front section, 2 x side sections, tensioning poles, curtains, pressure pole w/ foam padding, packing bag, pegs & tensioning material.

**Material**

Front & side sections made of polyester (210g/m<sup>2</sup>), transparent windows made of PVC.

**COLOR COMBINATION VILLA TOULOUSE**



The side and front sections are simply joined together with a zipper.



Thule Omnistor 1200 caravan awning see page 175



**VILLA TOULOUSE Caravan SET - complete set for THULE Omnistor 1200**

Type	Suitable for Thule 1200 with width	Att. height (H)	Depth (T)	Weight	Art. no.	Price
Toulouse 260	260 cm	230-250 cm	220 cm	12,5 kg	47584	319,-
Toulouse 300	300 cm	230-250 cm	250 cm	13,0 kg	47585	339,-
Toulouse 350	350 cm	230-250 cm	250 cm	13,5 kg	47586	359,-
Toulouse 400	400 cm	230-250 cm	250 cm	14,0 kg	47587	379,-
Toulouse 450	450 cm	230-250 cm	250 cm	14,5 kg	47588	399,-
Toulouse 500	500 cm	230-250 cm	250 cm	15,0 kg	47589	419,-



# MOSQUITO NET TENTS FOR AWNINGS, GLARE & PRIVACY PROTECTION



Depth 240cm



## Mosquito Free Premium - Mosquito net tents for awnings



- Fastening under the awning arms
- Available in 2 widths
- Keeps mosquitoes, wasps and other insects away
- Small pack size
- Suitable for many awnings
- With sewn-in floor

The mosquito net tent is simply attached to the awning arms with hooks and protects you from annoying mosquitoes, flies, wasps and other insects.

The Premium version is equipped with a sewn-in bottom.

The tent is suitable for many awning sizes, as hooks are attached to adjustable straps that can be set flexibly. It is secured to the ground with pegs.

The mosquito net tent has 2 side entrances and a large door to the vehicle. (zipper)

Dims.: Width 240 cm or 300 cm, depth approx. 230 cm, Height approx. 180 cm - 240 cm. Weight approx. 4.0 kg. Pack size L60 cm Ø30 cm

Scope of delivery: Mosquito net tent, pegs, packing bag.

<b>Mosquito Free Premium 240</b> , width 240 cm	<b>900164</b>	<b>109,-</b>
<b>Mosquito Free Premium 300</b> , width 300 cm	<b>900165</b>	<b>129,-</b>



## SunBreak - Glare & privacy protection for awnings

- Fine-meshed, air-permeable mesh
- Can be adjusted quickly and easily
- Suitable for all standard awnings

Modular protection, exactly where it is needed:

The SunBreak is inserted directly into the piping (Ø5mm) of the awning rail like a bag awning, the zipper is opened and the panel is pulled out continuously. The finely woven, air-permeable mesh creates exactly the privacy or sun protection you want. Thanks to the clever design, the SunBreak panel can be adjusted quickly and easily if, for example, the position of the sun changes.

The SunBreak can be tensioned with tensioning device included in scope of delivery so that it does not flap in light winds. The easy-to-handle suspension system allows the panel to slide easily into any desired position. Note: To avoid damage, stow the SunBreak back in the bag in stronger winds. If more sun protection is required, additional SunBreaks can be attached next to each other in the awning rail using a magnetic fastener. The SunBreak is available in black and gray-white. Suitable for all standard awnings. Can be rolled out to a max. of 2 m.

Weight: 2.85 kg.

Tech. data: Module width 1.10 m, panel width 1.06 m, roll-out length 2.00 m max., product width 1.15 m app., piping 5 mm, line length 2.00 m max., Mini TieStrap 0.45 m incl. eyelets.

Fabric: 30% polyester 70% PVC  
Cover material: 10% polyester 90% PVC  
Profiles: Powder-coated aluminum

A utensil bag is sewn inside the cover, with the following contents:  
2 x Peg&Stop screw peg S (blue) with lock nut 2.0 (orange)  
2 x tent rope for tensioning 2 m (white)  
2 x T-Connector (black)  
2 x TieStrap mini (completely black)

<b>black</b>	<b>44818</b>	<b>99,95</b>
<b>gray white</b>	<b>44819</b>	<b>99,95</b>





**Saona - Awnings - Sunblocker**

- With eyelets at the bottom for tensioning
- high-quality mesh fabric
- Incl. Pannier



① **Front panel** With double piping for awnings, multirail etc. With clips for rolling up. Material: Mesh fabric (mesh/PVC), double piping Ø: 5+7 mm, pegs + guy ropes included.

W 240 x H 190 cm	<b>44812</b>	<b>79,95</b>
W 280 x H 190 cm	<b>44813</b>	<b>89,95</b>
W 330 x H 190 cm	<b>44814</b>	<b>99,95</b>
W 380 x H 190 cm	<b>44815</b>	<b>109,95</b>
W 430 x H 190 cm	<b>44816</b>	<b>119,95</b>

② **Side panel**

For awnings with 250cm extension. Fixation with tension rod (must be ordered separately with adapter for awning). With clips for rolling up. Material: Mesh fabric (mesh/PVC), pegs, guy ropes and packing bag included.

Width 250 cm, H 190 cm	<b>44817</b>	<b>69,95</b>
------------------------	--------------	--------------

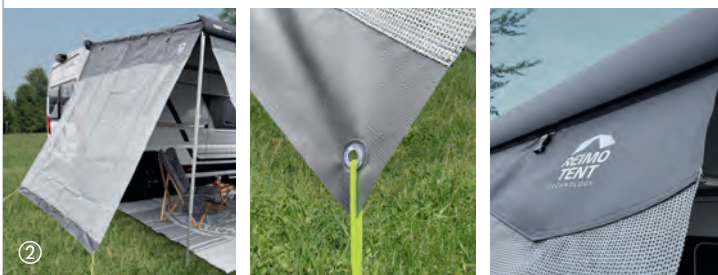

**Girona - Wind/rain blocker**

- Protection from wind & rain under awning
- Front panel for easy insertion into awning (piping)
- All panels can be connected to each other using piping profiles
- Large transparent PVC windows to protect against prying eyes with curtains (color: white)
- Dirt guard with attachment points at 3 different heights for optimum tensioning
- Material: Polyester

**Scope of delivery:**

**Front:** 1x panel, 8 piping profiles á 50cm, 2 curtains, ladders, pegs, guy ropes, packing bag

**Side:** 1x panel, 2 curtains, ladders, pegs, guy ropes, packing bag

① **Front panel, H 235-250 cm**

W 285, 1 door + 1 window	<b>44762</b>	<b>129,-</b>
W 330, 1 door + 1 window	<b>44763</b>	<b>149,-</b>
W 380, 1 door + 1 window	<b>44764</b>	<b>169,-</b>
W 430, 1 door + 1 window	<b>44765</b>	<b>189,-</b>
W 100, 1 window	<b>44766</b>	<b>49,95</b>

② **Side panel, for awning extension 250 cm, fastening with tension rods**

Mounting height 230-250 cm, 1 window

left:	<b>44760</b>	<b>69,95</b>
right :	<b>44767</b>	<b>69,95</b>

Mounting height 250-280 cm, 1 window

left:	<b>44761</b>	<b>79,95</b>
right:	<b>44768</b>	<b>79,95</b>

Tension rod not included! Must be ordered separately.



Keder profile for connecting panels

**Tension rods for side panels**

For Thule awnings (see also page 181)

For Thule Omnistor 5200/4900/5003/5002	<b>432974</b>	<b>61,-</b>
For Thule Omnistor 6200/6300/6002	<b>432977</b>	<b>61,-</b>
For Thule Omnistor 1200	<b>432972</b>	<b>61,-</b>

**Tension rods for side walls**

For Fiamma awnings (see also page 160)

For F45/F65/F80	<b>434554</b>	<b>54,90</b>
For Caravanstore XL	<b>434553</b>	<b>41,90</b>



# SELECTION GUIDE AWNING ADAPTERS FOR PANEL VANS & MAXIVANS

## Selection guide awnings and adapters









Which adapter fits my van with which awning?

You can see the answer from the tables. Select your vehicle length and height and you will see directly which adapter is possible with which awning type.

Adapters specified are for vehicles without additional attachments (e.g. roof rails).

For special solutions, you may need to use other adapters.



Fiat Ducato - Peugeot Boxer - Citroën Jumper from model year 2007				
	L1 (496 cm)	L2 (541 cm)	L4 (599 cm)	L5 (636 cm)
H1 (225 cm)	 max. 260 cm Thule wall awning with adapter 430631	 max. 300 cm Thule wall awning with adapter 430631	–	–
H2 (252 cm)	 max. 300 cm Thule roof awning with adapter 430092 Thule wall awning with adapter 430637 Fiamma wall awning with adapter 43316	 max. 325 cm Thule roof awning with adapter 430092 Thule wall awning with adapter 430637 Fiamma roof awning with adapter 43716 Fiamma wall awning with adapter 43316	 max. 375 cm Thule roof awning with adapter 430093 Thule wall awning with adapter 430638 Fiamma roof awning with adapter 43716 Fiamma wall awning with adapter 43316	 max. 400 cm Thule roof awning with adapter 430093 Thule wall awning with adapter 430639 Fiamma roof awning with adapter 434641 Fiamma wall awning with adapter 43316
H3 (276 cm)	–	–	 max. 350 cm Thule wall awning with adapter 430632 Fiamma roof awning with adapter 434642	 max. 400 cm Thule wall awning with adapter 430632 Fiamma roof awning with adapter 434642

Mercedes-Benz Sprinter from YOC. 2018				
	L1 (527 cm)	L2 (593 cm)	L3 (697 cm)	L4 (737 cm)
H1	Unfortunately, no suitable adapters are available for vehicle height H1 (236 cm)			
H2 (264 cm)	Fiamma F80s (width 290 cm) with adapter 43459 (UK=433621)	Thule Omnistor 6300 (B 325 cm) with Adapter 43041 Fiamma F80s (W320cm) adapter 43459 (UK=433621)	Thule Omnistor 6300 (W 375 cm) with Adapter 43041 Fiamma F80s (W370cm) Adapter 43459 (UK=433621)	Thule Omnistor 6300 (W 400 cm) with Adapter 43041 Fiamma F80s (W400cm) adapter 43459 (UK=433621)
H3	Unfortunately, no suitable adapters are available for vehicle height H3 (285 cm)			

Renault Master - Opel Movano from YOC. 2010				
	L1 (505 cm)	L2 (555 cm)	L3 (620 cm)	L4 (685 cm)
H1	Unfortunately, no suitable adapters are available for vehicle height H1 (231 cm)			
H2 (251 cm)	Unfortunately not possible	Thule roof awning (W 325 cm) with Adapter 426780 Fiamma roof awning with adapter 434581	Thule roof awning (W 375 cm) with Adapter 426780 Fiamma roof awning with adapter 434581	Thule roof awning (W 400 cm) with Adapter 426780
H3 (278 cm)	–	Thule wall awning (W 300 cm) with Adapter 430630	Thule wall awning (W 350 cm) with Adapter 430630	Thule wall awning (W 400 cm) with Adapter 430630

Mercedes Sprinter YOC. 06-18 / VW Crafter YOC. 06-17				
	L1 (525 cm)	L2 (591 cm)	L3 (695 cm)	L4 (735 cm)
H1	Unfortunately, no suitable adapters are available for vehicle height H1 (250 cm)			
H2 (280 cm)	Unfortunately not possible	Thule roof awning (B 325 cm) with Adapter 43041 Fiamma roof awning with adapter 43459 (UK=433621)	Thule roof awning (W 425 cm) with Adapter 43041 Fiamma roof awning with adapter 43459 (UK=433621)	Thule roof awning (W 450 cm) with Adapter 43041 Fiamma roof awning with adapter 43459 (UK=433621)
H3 (305 cm)	–	Unfortunately not possible	Fiamma wall awning with adapter 43477	Fiamma wall awning with adapter 43477

Ford Transit from Bj. 2014			
	L2 (553 cm)	L3 (598 cm)	L4 (670 cm)
H2 (243 cm)	Fiamma F80s (W 290 cm) with adapter 440616	Fiamma F80s (W 320 cm) with adapter 440617	–
H3 (267 cm)	Thule Omnistor 5200 (W 260 cm) w/ adapter Adapter 426776	Thule Omnistor 5200 (W 315 cm) with Adapter 426776 Fiamma F80s (W 320 cm) with adapter 440523 (UK=440614) Fiamma F45s with adapter 440595 (UK=440596)	Thule Omnistor 5200 (W 400 cm) with Adapter 426776 Fiamma F80s (W 400 cm) with adapter 43450 (UK=440615) Fiamma F45s with adapter 440595 (UK=440596)



Volkswagen Crafter ≥ 2017 - MAN TGE			
	L3 (599 cm)	L4 (684 cm)	L5 (739 cm)
H2	Unfortunately, no suitable adapters are available for vehicle height H2 (236 cm)		
H3 (269 cm)	Thule Omnistor 6300 (W 325 cm) with Adapter 43048 (UK=43055)	Thule Omnistor 6300 (W 400 cm) with Adapter 43048 (UK=43055) Fiamma F80s (W 320 cm) with adapter 434592 (UK=44490)	Thule Omnistor 6300 (W 450 cm) with Adapter 43048 (UK=43055) Fiamma F80s (W 400 cm) with adapter 434592 (UK=44490)
H4	Unfortunately, no suitable adapters are available for vehicle height H4 (280 cm)		





Roof awnings for Fiat Ducato, Peugeot Boxer, Citroën Jumper from YOC.

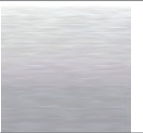

**Vehicle length 496 cm - short wheelbase (300 cm)**

<b>Height H2</b> (app. 252 cm)	<b>THULE® Omnistor 6300</b>			
	Width 300 cm, Extension 250 cm, Weight 23,0 kg			
				
	Mystic gray		Sapphire blue	
Housing White	<b>428301</b>	<b>428311</b>	<b>1009,-</b>	<b>1009,-</b>
Housing Black	<b>428340</b>		<b>1034,-</b>	—
Accessories needed	Adapter set	<b>430092</b>	<b>199,-</b>	
	Sealing tape	<b>43292</b>	<b>55,-</b>	
	Adhesive Sikaflex	<b>294111</b>	<b>20,60</b>	

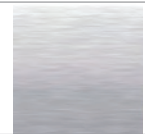

**Vehicle length 541 cm - med. wheelbase (345 cm)**

<b>Height H2</b> (app. 252 cm)	<b>FIAMMA F80s</b>		<b>THULE® 6300 VAN set</b>	
	Width 320 cm, Extension 250 cm, Weight 29.0 kg		Width 325 cm, Extension 250 cm, weight 24.0 kg	
				
	Royal Grey		Royal Blue	Mystic gray
Housing White	<b>436261</b>	<b>436268</b>	<b>428000</b>	<b>1078,-</b>
	<b>1078,-</b>	<b>1078,-</b>	<b>1324,-</b>	
Housing silver	<b>436275</b>	<b>436282</b>	<b>428072</b>	<b>1108,-</b>
	<b>1108,-</b>	<b>1108,-</b>	<b>1349,-</b>	
Housing Black	<b>436289</b>	—	<b>428075</b>	<b>1108,-</b>
	<b>1108,-</b>		<b>1349,-</b>	
Accessories needed	Adapter set 3-piece incl. sealing tape		Including adapter and sealing foam.	
	<b>43716</b>	<b>140,-</b>	Without glue.	
	Adhesive	<b>294111</b>	<b>20,60</b>	

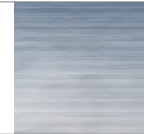
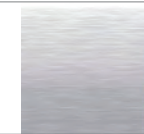

**Vehicle length 599 cm - long wheelbase (403 cm)**

<b>Height H2</b> (app. 252 cm)	<b>FIAMMA F80s</b>		<b>THULE® 6300 VAN set</b>	
	Width 370 cm, Extension 250 cm, Weight 32.0 kg		Width 375 cm, Extension 250 cm, weight 27.5 kg	
				
	Royal Grey		Royal Blue	Mystic gray
Housing White	<b>436263</b>	<b>436270</b>	<b>428001</b>	<b>1145,-</b>
	<b>1145,-</b>	<b>1145,-</b>	<b>1374,-</b>	
Housing silver	<b>436277</b>	<b>436284</b>	<b>428073</b>	<b>1165,-</b>
	<b>1165,-</b>	<b>1165,-</b>	<b>1399,-</b>	
Housing Black	<b>436291</b>	—	<b>428076</b>	<b>1165,-</b>
	<b>1165,-</b>		<b>1399,-</b>	
Accessories needed	Adapter set 3-piece incl. sealing tape		Including adapter & sealing foam.	
	<b>43716</b>	<b>140,-</b>	Without glue.	
	Adhesive	<b>294111</b>	<b>20,60</b>	

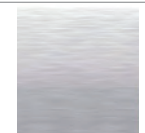
**Vehicle length 636 cm - long wheelbase (403 cm)**

<b>Height H2</b> (app. 252 cm)	<b>FIAMMA F80s</b>		<b>THULE® 6300 VAN set</b>	
	Width 400 cm, Extension 250 cm, Weight 34,0 kg		Width 400 cm, Extension 250 cm, weight 29.0 kg	
				
	Royal Grey		Royal Blue	Mystic gray
Housing White	<b>436264</b>	<b>436271</b>	<b>428002</b>	<b>1173,-</b>
	<b>1173,-</b>	<b>1173,-</b>	<b>1414,-</b>	
Housing silver	<b>436278</b>	<b>436285</b>	<b>428074</b>	<b>1219,-</b>
	<b>1219,-</b>	<b>1219,-</b>	<b>1439,-</b>	
Housing Black	<b>436292</b>	—	<b>428077</b>	<b>1219,-</b>
	<b>1219,-</b>		<b>1439,-</b>	
Accessories needed	Adapter set 3-piece incl. sealing tape		Including adapter and sealing foam.	
	<b>43716</b>	<b>140,-</b>	Without glue.	
	Adhesive	<b>294111</b>	<b>20,60</b>	

**Vehicle length 636 cm - long wheelbase (403 cm)**

<b>Height H3</b> (app. 276 cm)	<b>FIAMMA F80s</b>			
	Width 400 cm, extension 250 cm, weight 34.0 kg			
				
	Royal Grey		Royal Blue	
Housing White	<b>436264</b>	<b>436271</b>	<b>1173,-</b>	<b>1173,-</b>
Housing silver	<b>436278</b>	<b>436285</b>	<b>1219,-</b>	<b>1219,-</b>
Housing Black	<b>436292</b>		<b>1219,-</b>	—
Accessories needed	Adapter set	<b>434642</b>	<b>149,-</b>	
	Sealing tape	<b>434851</b>	<b>46,80</b>	
	Adhesive Sikaflex	<b>294111</b>	<b>20,60</b>	



Alternatively, on vehicles with height H3, a Side wall awning can be installed. For example a Thule Omnistor 5200 w/ adapter or a Fiamma F45 with adapter.



# Awning & adapter assignment for buses and vans

## Volkswagen Transporter 5/6/6.1

Vehicle version	Vehicle length short (489 cm)			Vehicle length long (529 cm)		
Transporter / Multivan / Caravelle with standard flat roof WITHOUT C-rail on the roof	Fiamma F40	(270 cm)	With adapter 440530 (UK=440531)	Fiamma F40	(270 cm)	With adapter 440530 (UK=440531)
	Fiamma F43	(270 cm)	With adapter 440707 (UK=440708)	Fiamma F43	(300 cm)	With adapter 440707 (UK=440708)
	Fiamma F45	(260 cm)	With adapter E4631 (UK=E4830)	Fiamma F45	(260 cm)	With adapter E4631 (UK=E4830)
	Fiamma F35	(270 cm)	With adapter 433403 (UK=433404)	Fiamma F35	(270 cm)	With adapter 433403 (UK=433404)
	Thule 4200/5200	(260 cm)	With adapter 426702 (UK=426703)			
Transporter / Multivan / Caravelle with standard flat roof WITH C-rail on the roof	Thule 3200	(270 cm)	With adapter 42690 (UK=42696)			
	Fiamma F40	(270 cm)	With adapter 440618 (also UK)	Fiamma F40	(270 cm)	With adapter 440618 (also UK)
	Fiamma F43	(270 cm)	With adapter 440716 (UK=440717)	Fiamma F43	(300 cm)	With adapter 440716 (UK=440717)
	Fiamma F45	(260 cm)	Set 4376730 (silver) incl. adapter (UK=4376740)	Fiamma F45	(300 cm)	Set E46270 (silver) incl. adapter (UK=4376742)
	Fiamma F45	(260 cm)	Set 4376780 (black) incl. adapter (UK=4376782)	Fiamma F45	(300 cm)	Set E10168 (black) incl. adapter (UK=4376783)
With pop-up roof, WITHOUT side rail	Fiamma F35	(270 cm)	With adapter 43340	Fiamma F35	(300 cm)	With adapter 43340
	Thule 5102	(260 cm)	With adapter 426716 (UK=426717)			
	Thule 4200 / 5200	(260 cm)	With adapter 426702 (UK=426703)	Thule 4200/5200	(300 cm)	With adapter 426702 (UK=426703)
	Fiamma F43	(270 cm)	With adapter 440534			
	Fiamma F45	(260 cm)	With adapter 440534 or 426768	Fiamma F45	(300 cm)	With adapter 426768
With REIMO Multirail - Also with pop-top roof	Fiamma F35	(270 cm)	With adapter 440533 or 426768 (UK=440533)	Fiamma F35	(270 cm)	With adapter 426768
	Thule 4200	(260 cm)	With adapter 436704 (UK=426705)	Thule 4200	(300 cm)	With adapter 426706 (UK=436707)
	Thule 3200	(270 cm)	With adapter 42691 (UK=42697)	Thule 3200	(300 cm)	With adapter 426911 (UK=426971)
	Fiamma F43	(270 cm)	With adapter 440525			
With Brandrup Top-Rail - Also with pop-top roof	Fiamma F45	(260 cm)	With adapter 440525			
	Fiamma F35	(270 cm)	With adapter 440523 (also UK)			
	Thule 4200 / 5200	(260 cm)	With adapter 43025			
	Fiamma F43	(270 cm)	With adapter 440714			
Volkswagen California WITH original Volkswagen side rail	Fiamma F45	(260 cm)	Set 4376709 (white) incl. adapter			
	Fiamma F45	(260 cm)	Set 4379710 (silver) incl. adapter			
	Fiamma F45	(260 cm)	Set 4376760 (black) incl. adapter			
	Fiamma F35	(270 cm)	With adapter 433401			

## Renault Trafic 3 > 2014, Nissan NV300 / Primastar > 2014, Opel Vivaro B 2014-2019, Fiat Talento 2016-2021

Vehicle version	Vehicle length L1 (500 cm)			Vehicle length L2 (540 cm)		
Box and station wagon	Fiamma F40	(270 cm)	With adapter 44349	Fiamma F40	(270 cm)	With adapter 44338
	Fiamma F43	(270 cm)	With adapter 440712	Fiamma F43	(300 cm)	With adapter 440712
	Fiamma F45	(230 cm)	With adapter 433132	Fiamma F45	(260 cm)	With adapter 433133
	Fiamma F35	(220 cm)	With adapter 433132	Fiamma F35	(250 / 270 cm)	With adapter 433132
	Thule 4200/5200	(230 cm)	With adapter 43105 (also UK)			
	Thule 3200	(230 cm)	With adapter 42698 (also UK)	Thule 3200	(250 cm)	With adapter 42695 (also UK)

## Citroën Spacetourer/Jumpy 3, Peugeot Traveller/Expert 3, (all from '16), Opel Vivaro C/Zafira Life (all from '19), Fiat Scudo 3/Ulysse (all from '21)

Vehicle version	Vehicle length 495 cm		
Also Pössl Campster with pop-up roof	Fiamma F40	(270 cm)	With adapter 443371
	Fiamma F43	(270 cm)	With adapter 440715
	Fiamma F45	(260 cm)	Set 437680 (white) incl. Adapter
	Fiamma F45	(260 cm)	Set 437681 (black) incl. adapter
	Fiamma F35	(250 / 270 cm)	With adapter 44329
	Thule 4200	(260 cm)	With adapter 426708 (UK=426709)
	Thule 4200	(260 cm)	With adapter 426778 (UK=426779)
Thule 3200	(270 cm)	With adapter 42693 (UK=42699)	

## Mercedes-Benz Vito from 2014

Vehicle version	Vehicle length long (514 cm)		
W447  W447 with REIMO Multirail - Also with REIMO pop-top roof W447 with SCA pop-up roof 152	Fiamma F40	(270 cm)	With adapter 44337
	Fiamma F35	(250 / 270 cm)	With adapter 433412
	Thule 4200	(260 cm)	With adapter 426766
	Thule 4200/5200	(260 cm)	With adapter 426713
Marco Polo with manual pop-top roof  Jule Verne	Fiamma F43	(270 cm)	With adapter 443413
	Fiamma F45	(260 cm)	With adapter 433413
	Fiamma F35	(250 / 270 cm)	With adapter 433413
Fiamma F35	(250 / 270 cm)	With adapter 433414	

## Ford Transit Custom YOC. 2012 - 2023

Vehicle version	Vehicle length L1 (497 cm)			Vehicle length L2 (534 cm)		
Transit Custom / Tourneo Custom from 2012	Fiamma F40	(270 cm)	With adapter 44336 (UK=443000)	Fiamma F40	(270 cm)	With adapter 44339
	Fiamma F43	(270 cm)	With adapter 440602 (UK=4406039)			
	Fiamma F45	(260 cm)	With adapter 43434 (UK=436259)			
	Fiamma F35	(250 / 270 cm)	With adapter 43434 (UK=436259)			
	Thule 4200	(260 cm)	With adapter 426710 (UK=426711)			
	Thule 3200	(270 cm)	With adapter 42694 (UK=42679)			
Transit Custom Nugget w/ pop-top roof from 2015	Fiamma F43	(270 cm)	With adapter 434563			
	Fiamma F45	(260 cm)	With adapter 434563			
Transit Nugget Plus with high roof from 2012				Fiamma F43	(270 cm)	With adapter 434561
				Fiamma F45	(260 cm)	With adapter 434561
				Thule 4200/5200	(260 cm)	With adapter 430600
Cap Coast from 2018	Fiamma F35	(220 cm)	With adapter 44335			
Cap Land / Cap Fun 2015-2018				Fiamma F35	(250 cm)	With adapter 433416
Cap Land / Cap Fun from 2019				Fiamma F35	(250 cm)	With adapter 434335



The company Fiamma is an Italian camping accessories manufacturer with a 75-year tradition. As an innovative company Fiamma holds over 100 patents in Europe, USA, Japan, Taiwan and Australia. The program includes awnings for wall, roof and keder rail mounting. Rich accessories, such as awnings and other products for motorhomes and caravans, allow useful extensions. Italian design is evident in all products and offers great looks in addition to functionality.

## Different types of awnings



### Roof awning Fiamma F80S

Widths: 290 - 450 cm  
Pull-put: up to 250 cm  
Fabric colors: Royal Grey, Royal Blue  
Housing colors: Polar White, Titanium, Deep Black



### Roof awning Fiamma F80L

Widths: 450 - 600 cm  
Pull-put: up to 275 cm  
Fabric colors: Royal Grey, Royal Blue  
Housing colors: Polar White, Titanium, Deep Black



### Roof awning Fiamma F40 VAN

Widths: 210 + 270 cm  
Pull-put: until 225 cm  
Fabric colors: Royal Grey  
Housing colors: Deep Black



### Wall awning Fiamma F45S

Widths: 260 - 450 cm  
Pull-put: up to 250 cm  
Fabric colors: Royal Grey, Royal Blue  
Housing colors: Polar White, Titanium, Deep Black



### Wall awning Fiamma F45L

Widths: 450 - 550 cm  
Pull-put: up to 250 cm  
Fabric colors: Royal Grey, Royal Blue  
Housing colors: Polar White, Titanium, Deep Black



### Fiamma F43 VAN wall awning

Widths: 270 + 300 cm  
Pull-put: up to 250 cm  
Fabric colors: Royal Grey  
Housing colors: Deep Black



### Wall awning Fiamma F35 PRO

Widths: 180 - 300 cm  
Pull-put: until 225 cm  
Fabric colors: Royal Grey, Royal Blue  
Housing colors: Titanium, Deep Black



### Special awning Fiamma SlideOut

Widths: 200 - 280 cm  
Pull-put: up to 100 cm  
Fabric colors: Royal Grey  
Housing colors: Polar White



### Housing awning Fiamma Caravanstore

Widths: 190 - 550 cm  
Pull-put: up to 250 cm  
Fabric colors: Royal Grey, Royal Blue  
Lining colors: Light gray, black

## Housing colors



POLAR WHITE



TITANIUM



DEEP BLACK

## Fabric colors

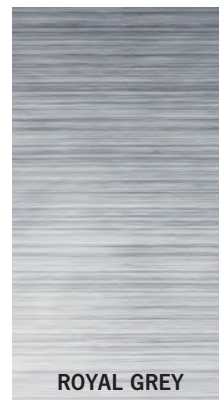

ROYAL GREY

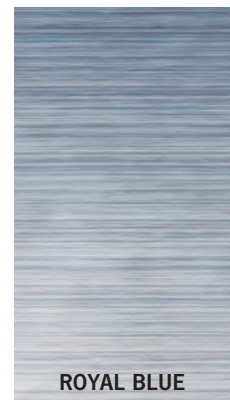

ROYAL BLUE





Fiamma F80S  
Awning set for Fiat Ducato

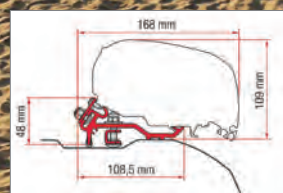

**F80s awning set**

**Fabric in Royal Grey**

Suitable for: Fiat Ducato, Peugeot Boxer, Citroën Jumper ≥ 2007, Opel Movano ≥ 2021.

Awning version F80s for vehicle height H2 (252 cm). in the Deep Black version. Extension 250 cm.

**For vehicles with:**

- Length 541 cm = awning 320 cm
- Length 599 cm = awning 370 cm
- Length 636 cm = awning 400 cm



**Polar White housing - Royal Grey fabric**

320 cm	29 kg	436347	1248,-
370cm	32 kg	436348	1314,-
400 cm	34 kg	436349	1364,-

**Housing Deep Black - Fabric Royal Grey**

320 cm	29 kg	440457	1257,-
370cm	32 kg	440458	1322,-
400 cm	34 kg	440459	1376,-

**Scope of delivery:**

- Awning F80s in body color Deep Black or Polar White
- Adapter - Kit Fiat Ducato / Citroën Jumper / Peugeot Boxer / Opel Movano from 2021 - Low Profile ≥ 2006 - H2
- Black seal to protect against water

**Privacy ULTRA Light awning for Fiat Ducato panel van**



- One-piece, underhung tent made of side panels, front and roof
- Front window fixed, front panel removable
- Side windows with blackout and mosquito net, side walls can be opened
- Incl. Pannier

Suitable for: Fiat Ducato panel van, Peugeot Boxer, Citroen Jumper, Opel Movano.

**Scope of delivery** Tent consisting of roof, front and side walls, mounting kit for Fiamma awnings, cross-rafters, tension straps with pegs and transport bag.

**Further information:** See page 139

**Privacy ULTRA Light awning for Ducato H2**

Awning width	Type	Weight	Art. no.	Price
320 cm	UL 300	14,2 kg	435950	1239,-
370 cm	UL 350	15,4 kg	435951	1276,-
400 cm	UL 400	16,6 kg	435952	1386,-

**Privacy ROOM Light for Fiat Ducato panel van**



- Consisting of side panels and front
- Mounted on vehicle wall with magnets
- Front window roll up, with mosquito net
- Side windows with blackout and mosquito net
- Door usable left and right
- Zippers connect front and side walls

Suitable for: Fiat Ducato panel van, Peugeot Boxer, Citroen Jumper, Opel Movano.

**Further information:** See page 141

**Privacy ROOM Light - awning tent for Ducato H2**

Awning width	Basic model			+ extension set		
	Width	Art. no.	Price	Wide	Item no.	Price
320 cm	300 cm	440572	1125,-	+20 cm	440497	48,-
370 cm	300 cm	440572	1125,-	+70 cm	440578	64,30
400 cm	300 cm	440572	1125,-	+100 cm	440501	103,-





**Fiamma F80S**  
Sturdy awning w/ aluminum end caps



Preparation for LED lighting

3 keder rails in the front profile

Fiamma F80S with triple keder rail in the front profile							
Type	290	320	340	370	400	425	450
For Ducato H2 from YOC. '07	Vehicle length 496 cm	Vehicle length 541 cm		Vehicle length 599 cm	Vehicle length 636 cm		
For Ducato H2 until YOC. '07	Wheelbase 320 cm		Wheelbase 370 cm				
Awning width A	290 cm	320 cm	340 cm	370 cm	400 cm	425 cm	450 cm
Fabric width B	278 cm	308 cm	328 cm	358 cm	388 cm	412 cm	431 cm
Pull-out C	200 cm	250 cm	250 cm	250 cm	250 cm	250 cm	250 cm
Weight	27,0 kg	29,0 kg	30,0 kg	32,0 kg	34,0 kg	35,0 kg	36,5 kg

Housing Polar White							
Royal Grey	436260	436261	436262	436263	436264	436265	436266
Price	960,-	1078,-	1095,-	1145,-	1173,-	1240,-	1240,-
Royal Blue	436267	436268	436269	436270	436271	436272	436273
Price	957,-	1078,-	1091,-	1145,-	1173,-	1240,-	1240,-

Housing Titanium							
Royal Grey	436274	436275	436276	436277	436278	436279	436280
Price	983,-	1108,-	1123,-	1165,-	1219,-	1272,-	1272,-
Royal Blue	436281	436282	436283	436284	436285	436286	436287
Price	991,-	1108,-	1123,-	1165,-	1219,-	1272,-	1272,-

Housing Deep Black							
Royal Grey	436288	436289	436290	436291	436292	436293	436294
Price	991,-	1108,-	1123,-	1165,-	1219,-	1272,-	1272,-

**Scope of delivery Fiamma F80S:**  
Awning crank, support foot attachment to wall, pegs.  
From awning width 400 cm incl. alu tensioning rod.

**The compact roof awning with front keder profile and aluminum end caps**

- Extension up to 2.50 m, width up to 4.50 m
- Slim aluminum housing and end caps
- Preparation for LED light strips on front panel and housing
- Open and close with crank, no slipping, safe hooking and unhooking
- Space-saving mounting on the vehicle roof
- 12 volt motor can be retrofitted
- Mounting adapter suitable for many different types of vehicles

Suitable for: Sprinter, Volkswagen Crafter, Fiat Ducato, Peugeot Boxer, Citroën Jumper. Also for: Motorhomes and caravans.

**Accessories for Fiamma F80S:**

- Fiamma mounting adapter (required) Page 137-139
- Fiamma awning awnings Page 140-141
- Fiamma front and side walls Page 155-157
- Fiamma tie rods Page 160
- Fiamma LED strips Page 188

**Telescopic Rafter Arm**



Additional tensioning rod for F80S. For more stability and greater resistance to wind. Integrated into the awning arms they can be used when required.

When unfolded, they hook in the frontprofile.

**440584 48,40**



# Fiamma F80L

Maximum extension up to 275 cm



Preparation for LED lighting



Dual Shock Absorber

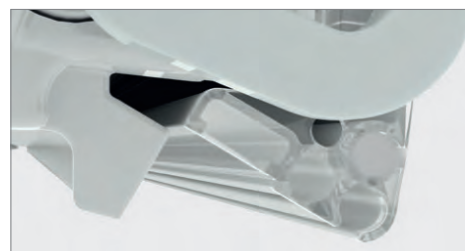

3 keder rails in the front profile

Fiamma F80L w/ triple keder rail in front profile				
Type	450	500	550	600
Awning width A	454 cm	497 cm	547 cm	597 cm
Fabric width B	438 cm	480 cm	530 cm	580 cm
Pull-out C	275 cm	275 cm	275 cm	275 cm
Weight	43,8 kg	46,5 kg	50,0 kg	54,5 kg

## The compact roof awning with front keder profile and aluminum end caps

- Length from 450 to 600 cm
- Extension 275 cm
- Rain Guard as standard
- 3 keder rails in the front profile
- Preparation for LED lighting

Housing Polar White				
Royal Grey	436014	436019	436024	436029
Royal Blue	436013	436018	436023	436028
Price	1603,-	1752,-	1909,-	2066,-

New awning F80L w/ roof mounting & winch, which is particularly suitable for large vehicles. It provides plenty of space in front of camper thanks to the large extension of 275 cm. Available in 4 lengths: from 450 to 600 cm.

Housing Titanium				
Royal Grey	436016	436021	436026	436031
Royal Blue	436015	436020	436025	436030
Price	1670,-	1843,-	1999,-	2149,-

### Accessories for Fiamma F80L:

Fiamma mounting adapter (compulsory)	Page 137-139
Fiamma awning awnings	Page 140-141
Fiamma front and side walls	Page 155-157
Fiamma tie rods	Page 160
Fiamma LED strips	Page 188

Housing Deep Black				
Royal Grey	436017	436022	436027	436032
Price	1670,-	1843,-	1999,-	2149,-

### Scope of delivery Fiamma F80S:

Awning crank, support foot attachment to wall, pegs.



### Telescopic Rafter Arm



Additional tensioning rod for F80L. For more stability and greater resistance to wind. Integrated into the awning arms, they can be used as required. When unfolded, they are hooked into front profile.

440585 51,90



For high roof H2

**Kit Skyroof for Fiat Ducato, Peugeot Boxer, Citroën Jumper RHD + LHD.**  
> 7/06, 3 pcs. (3x35 cm).  
**440517 169,-**

For high roof H2

**Flat adapter kit for Fiat Ducato, Peugeot Boxer, Citroën Jumper or Opel Movano > 2021 without front panoramic roof hood**  
> 7/06, Only for F80s. Right Hand Drive + Left Hand Drive

For L2 / L4 and awning width up to 370 cm, 3-piece . (1x20cm/1x15cm/1x12cm).  
**Adapter Kit Silver 440527 170,-**  
**Adapter Kit Black 440528 205,-**

For L5 and awning width 400 cm. 3-piece . (2x26cm/1x12cm)  
**Adapter Kit Silver 440526 202,-**

**KIT consisting of:**  
Brackets with Rain Guard Slim Kit 450 cm and Kit Cover.

Kit Cover      Rain Guard Slim

For high roof H2

**Fiat Ducato, Peugeot Boxer, Citroën Jumper**  
> 7/06, for L2 / L4 and awnings up to 370 cm and L5 up to 400 cm. 3-piece . (1x20cm/1x15cm/1x12cm).

**Right Hand Drive + Left Hand Drive**  
**Silver 43716 140,-**  
**Black 43717 195,-**

Also for Opel Movano > 2021

For high roof H2

Also for Opel Movano > 2021

**Fiat Ducato, Peugeot Boxer, Citroën Jumper**  
> 7/06, for L5 and Awning width 400 cm.  
**3-pcs. 434641 176,-**

For high roof H3

**Fiat Ducato, Peugeot Boxer, Citroën Jumper**  
> 7/06, for L4 / L5 and Super high roof H3.  
**3-pcs. 434642 149,-**

For high roof H2

**Fiat Ducato, Peugeot Boxer, Citroën Jumper**  
1994-06/2006  
**2-pcs. 43478 108,-**

H3 (259 cm)

**VW Crafter >2017 MAN TGE**  
with roof rail, specified L4=320 cm, L5=400 cm  
**434591 303,-**

For height H3 (app. 259 cm) without Roof Rail

**VW Crafter, MAN TGE >2017**  
specified awning width L4=320 cm, L5=400cm, 3 holders (2 x 20 cm, 1 x 32 cm)  
**434592 368,-**  
**UK= 44490 368,-**

For high roof H2

**Kit Fiat Ducato Smart Clamp System**  
For mounting the awning F80s on Thule roof rack system Smart Clamp.  
For L2 / L4 / L5.  
3 holders (2x20cm/1x12cm)  
**Set 43505 150,-**

F80S

**Ford Transit from 14**  
H2/L2, 290cm **440616 219,-**  
H2/L3, 320cm **440617 225,-**

H2 (280 cm)  
L2=320 cm L3=370 cm L4=400 cm

**MB Sprinter all >2007, VW Crafter 2007-2017**  
3 holders each 53, 60 & 12 cm  
**43459 164,-**  
**UK version 433621 162,-**

H2 (280 cm)  
L2=320 cm L3=370 cm L4=400 cm

**MB Sprinter >2007, VW Crafter 2007-2017 with Roof Rail**  
3 holders (2 x 40 cm, 1 x 12 cm)  
**43471 140,-**

Renault Master / Opel Movano >2010

**Renault Master / Opel Movano >2010**  
3 Holder **434581 157,-**

Renault Master 1997 - 2009 and Opel Movano 1998 - 2010

**Renault Master 1997 - 2009 and Opel Movano 1998 - 2010**  
3 holders, 2 x 29 cm, 1 x 12 cm  
**43458 140,-**

Ford Transit >2014

**Ford Transit >2014**  
H3/L3, 320cm **440523 223,-**  
H3/L4, 400cm **43450 389,-**  
H3/L3, 320cm, UK version **440614 223,-**  
H3/L4, 400cm, UK version **440615 389,-**

**For FIAMMA F80S and F80L**

**Railing incl. awning adapter**

- Mounting on the original points
- Mounting without drilling
- With 4 crossbars
- Load capacity 100 kg

Suitable for: Fiat Ducato, Peugeot Boxer, Citroën Jumper > 2007

Roof rail/rack incl. awning mounting adapter. For mounting the awning on the right-hand side of the vehicle. For Ducato ≥ 2007

**41099 802,-**

**Iveco Daily 2006-2014**  
Bonding necessary  
2 holders à 15 cm 1 holder à 20 cm  
Awning width:  
L2=320cm, L3=370cm  
**SA831 115,-**



# ADAPTER FOR F80S, F80L AND F65

## Adapter F80 and F65 for motorhomes

For adapter 43716 + 43717

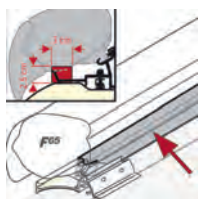

### RainGuard Kit F65/F65S

Protects against water penetration between the awning and the vehicle wall.

450 cm **434851** 46,80



### Adapter LMC - TEC

450 cm **436243** 324,-  
500 cm **436244** 346,-  
550 cm **436245** 375,-  
600 cm **436246** 403,-

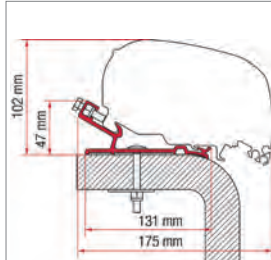

### Adapter Hymer

550 cm **436247** 388,-  
600 cm **436248** 388,-



### Kit Laika Kreos 21

4x15 cm **436249** 102,80

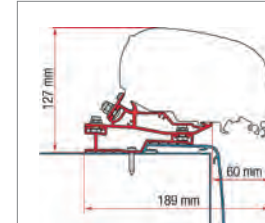

### Adapter Rapido C Line

340 cm **436250** 315,-  
400 cm **436251** 347,-  
425 cm **436252** 358,-  
450 cm **436253** 368,-



### Adapter Rapido C55i C86i

500 cm **440516** 382,-

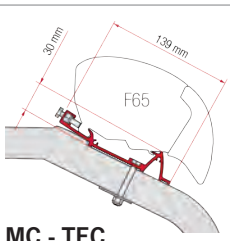

### LMC - TEC

LMC Liberty TI  
one-piece profile bar,  
bonding necessary  
370 cm **SA852** 274,-  
400 cm **E2589** 283,-

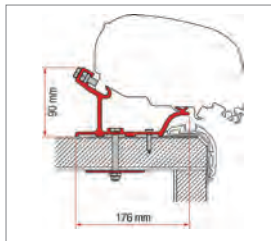

### Kit Carthago Malibu

340 cm **44485** 281,-  
400 cm **44486** 319,-  
450 cm **44487** 380,-  
490 cm **44488** 392,-



### Arca Mobilvetta K-Yacht

3 holder à 15 cm **44481** 108,-

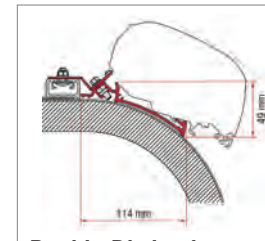

### Rapido Distinction

400 cm **44482** 306,-  
450 cm **44483** 334,-  
490 cm **44484** 334,-  
600 cm **436254** 399,-

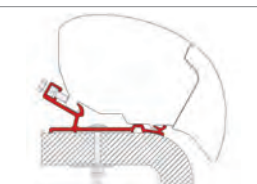

### Hymer adapter

one piece profile bar  
320 cm **44401** 248,-  
370 cm **44402** 280,-  
400 cm **44403** 280,-  
450 cm **44404** 322,-  
490 cm **44400** 330,-

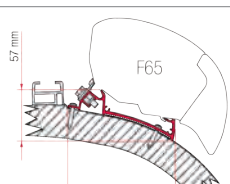

### Carthago Chic

one-piece profile bar,  
Bonding necessary  
450 cm **SA285** 331,-  
400 cm **E1106** 276,-  
490 cm **E10083** 337,-

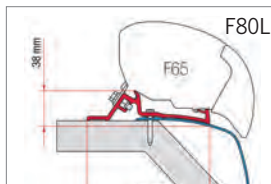

### Laika Rexosline/ Ecovip Laola Kreos 2009-2021

Bonding necessary  
4 holders à 15 cm **SA850** 170,-  
500 cm **440604** 392,-

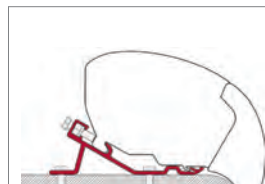

### Kit standard

3 holders à 20 cm **43473** 113,-

## Caravan adapter for F65L + F80L and F80s

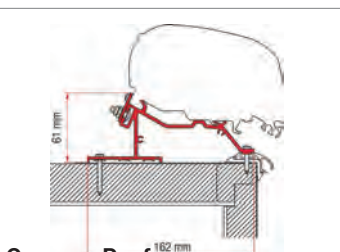

### Caravan Roof

For Dethlefs, Fendt, LMC, Trigano and others.

290 cm **44493** 258,-  
320 cm **44494** 259,-  
340 cm **44496** 273,-  
370 cm **44497** 318,-  
400 cm **44498** 320,-  
425 cm **44499** 347,-  
450 cm **44474** 364,-  
500 cm **44306** 384,-

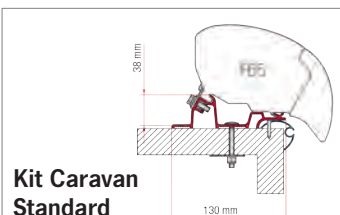

### Kit Caravan Standard

Bonding necessary  
2 holders à 50 cm, 2 holders à 30 cm  
320 cm **434643** 203,-  
340 cm **440605** 221,-  
370 cm **440606** 221,-  
400 cm **440607** 255,-  
425 cm **440608** 273,-  
450 cm **440609** 306,-  
500 cm **440610** 306,-  
550 cm **440611** 306,-  
600 cm **440612** 361,-  
600 cm **440613** 361,-

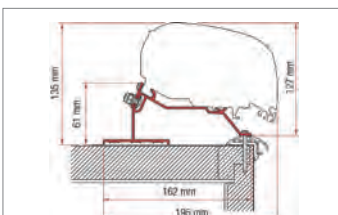

### Adapter Caravan Roof

550 cm **436255** 413,-  
600 cm **436256** 456,-



### Kit Adria Caravan >2015

Single adapter 2x50+2x27cm  
450 cm **440518** 198,-  
500 cm **440519** 363,-  
550 cm **440520** 414,-  
550 cm **440521** 444,-  
600 cm **440522** 484,-



### Support bars Fixing Bar Pro L

#### Kit Fixing Bar

Rail with 2 white painted End/mounting pieces.  
1 piece **41114** 79,-

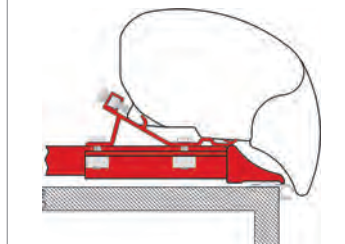

#### Kit Fixing Bar

For mounting on Fiamma Fixing Bar Pro L (see above). Use 2 fixing bars up to 3.50 m and 3 pieces from 4 m awning width.  
**43470** 126,-



### Mounting kit for LMC caravans

4 washers, bolts and nuts **43506** 9,20

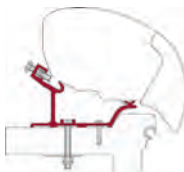

**Hobby Easy & Ontour.**  
4 holders (2x50cm, 2x30cm)  
**434764 207,-**



**Hobby Premium & Ontour > 2012**  
4 holders (2x25 cm, 2x50 cm)  
**44308 218,-**

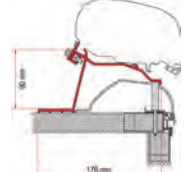

**Hobby Caravan > 2014**  
4 holders (2x27 cm, 2x60 cm)  
**44307 227,-**



**Hobby Excellent**  
4 holders (2x50 cm, 2x30 cm)  
**434763 274,-**

### Motor kits F80S and F65S

**12 V Motor Kit Compact for F80s**  
For retrofitting. Increases the width of the awning by 12 cm. With switch for electric Connection and emergency crank.

**Motor + switch** 12V



Polar White	<b>436295</b>	<b>511,-</b>
Titanium	<b>436296</b>	<b>511,-</b>
Deep Black	<b>436297</b>	<b>511,-</b>

**Upgrade Kit Advanced** for Compact F80s engine kit  
**436405 255,-**

**12 V Motor Kit Plus for F80s**  
Remote control with infrared remote control and wall control. The control unit can be used to automatically tension the awning cloth when it is opened; opening and closing can also be done via the automotive "One Touch" system.

**Motor + switch + remote control**



Polar White	<b>436298</b>	<b>578,-</b>
Titanium	<b>436299</b>	<b>578,-</b>
Deep Black	<b>436300</b>	<b>578,-</b>

**12 V Motor Kit Advanced for F80s**  
Operate your awning conveniently from your smartphone. Thanks to practical Fiamma app (for Android or iOS systems) you can control opening & closing of the awning F80s from your mobile.

**Motor + Switch + App**



Polar White	<b>43676</b>	<b>679,-</b>
Titanium	<b>43677</b>	<b>679,-</b>
Deep Black	<b>43678</b>	<b>679,-</b>

### Motor kits F80L and F65L

**12 V Motor Kit Compact for F80L**  
For retrofitting. Increases the width of the awning by 12 cm. With switch for electric Connection and emergency crank. Weight 2.4 kg.

**Motor + switch** 12V



Polar White	<b>440461</b>	<b>552,-</b>
Titanium	<b>440462</b>	<b>552,-</b>
Deep Black	<b>440460</b>	<b>552,-</b>

**12 V Motor Kit Advanced for F80L**  
Operate your awning conveniently from your smartphone. Thanks to practical Fiamma app (for Android or iOS systems) you can control opening & closing of awning F80L from your mobile. Weight 2.5 kg.

**Motor + Switch + App**



Polar White	<b>440464</b>	<b>722,-</b>
Titanium	<b>440465</b>	<b>722,-</b>
Deep Black	<b>440463</b>	<b>722,-</b>

**Motor Kit Compact F65L**

- Smaller dimensions
- Constructive simplicity
- Reliability
- excellent performance

Motor Kit Compact for the awning F65L.

**Motor + switch**



Polar White	<b>436305</b>	<b>552,-</b>
Titanium	<b>436306</b>	<b>552,-</b>
Deep Black	<b>436307</b>	<b>552,-</b>

### The Quick-assembly awning

- One-piece, underhung tent made of side panels, front and roof
- Material: Polyester Ripstop
- Mounting with transverse frame
- Front window fixed, front panel removable
- Side windows with blackout and mosquito net, side walls can be opened
- Incl. Bag Megabag light, for UL 400 with bag Megabag
- Incl. Curtains for front windows

**Scope of delivery** Tent consisting of roof, front & side walls, assembly kit for Fiamma awnings, cross frames, tensioning straps w/ pegs & transport bag.

#### Accessories

Curtains, 1 pair, Dark Grey	<b>440486</b>	<b>76,90</b>
Curtains, 3 pairs, Dark Grey	<b>440487</b>	<b>193,-</b>
Windshields		Page 185

### Fiamma Privacy Ultra Light



### Privacy ULTRA Light - Awning awning for F80s

Type	Width awning	Mounting height (B) 230-280 cm		
		Weight		Price
UL 300	300 cm, 320 cm	14,2 kg	435950	1239,-
UL 350	350 cm, 370 cm	15,4 kg	435951	1276,-
UL 400	400 cm	16,6 kg	435952	1386,-
UL 450	450 cm	17,8 kg	435953	1428,-



## Fiamma Privacy Room Awning awning for Fiamma F80, F80L and F65



### Fiamma Privacy Room

- With **FAST CLIP** system for windproof connection between awning fabric & side panels
- Zippers between front and side wall
- Door usable left or right

#### Scope of delivery

Front part with door & window, two side walls with window and mosquito net, clip system profile, pack bag, curtains.

#### Accessories

Curtains, 1 pair	Dark Grey	
<b>440486</b>		<b>76,90</b>
Curtains, 3 pair	Dark Grey	
<b>440487</b>		<b>193,-</b>
Windshields		Page 185

### Robust awning for F65/F80 with extension C = 250 cm

\* This set includes a kit with 2 x 6 magnets incl., which ensure adhesion to Vehicle .

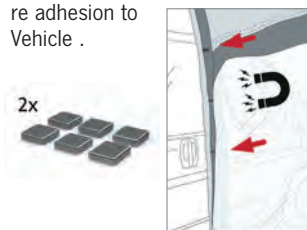

\*\* With additional magnetic attachment.

\*\* For Mercedes-Benz Sprinter, Volkswagen Crafter, Fiat Ducato, Citroën Jumper or Peugeot Boxer H3 vehicles, the Fast Clip Light aluminum linkage is included in the scope of delivery.

\*\*\* Specified model for vehicles w/ straight wall, height from floor 245 - 280 cm.

Basic model	For Ducato >06*		For panel van H3**		Alcove + semi-integrated***	
	Small/Van (W = 245 cm)		Medium (B = 245-280 cm)		Large (B = 245-280 cm)	
A = 300 cm	440485	1413,-	440570	1626,-	435042	1604,-

Extension to awning width	Front panels	Front extension sets to adjust the width					
		320 cm	K: 20 cm	436620	55,20	436620	55,20
340 cm	M: 40 cm	436621	61,-	436621	61,-	436621	61,-
370 cm	O: 70 cm	436622	78,70	436622	78,70	436622	78,70
400 cm	Q: 100 cm	436623	121,-	436623	121,-	436623	121,-
425 cm	R: 125 cm	436624	150,-	436624	150,-	436624	150,-
450 cm	U: 150 cm	436625	173,-	436625	173,-	436625	173,-

**IMPORTANT:** Adapter E3616 is required for mounting on the F65s awning.

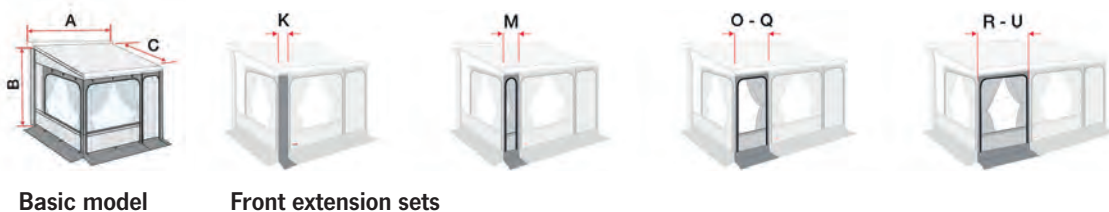

### Awning for F80L with extension C = 275 cm

Basic model	XL (B = 245-280 cm, C = 275 cm)		XXL (B = 281-310 cm, C = 275 cm)	
	A = 300 cm	435043	1615,-	435044

Extension to awning width	Front panels	Front extension sets to adjust the width			
		450 cm	U: 150 cm	436625	173,-
500 cm	W: 200 cm	435313	207,-	435313	207,-
550 cm	W: 200 cm	435313	207,-	435313	207,-
	+ I: 50 cm	435311	61,-	435311	61,-
600 cm	W: 200 cm	435313	207,-	435313	207,-
	+ P: 100 cm	436623	121,-	436623	121,-

Basic model (XL, XXL)

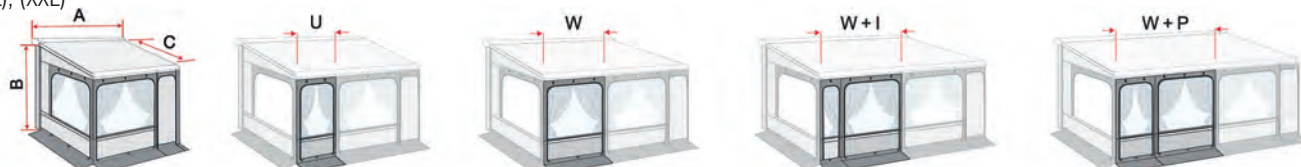

## Fiamma Privacy Room Light

### The lightweight awning awning



#### Privacy ROOM Light for F80S - Awning canopy without awning

Basic model	Small * (e.g. Ducato >06) A = 300 cm B = 245 cm C = 250 cm	Medium ** (Caravans / motorhomes) A = 300 cm B = 245 - 280 cm C = 250 cm	Large * (H3 panel van) A = 300 cm B = 280 cm C = 250 cm
Weight	14,6 kg	14,8 kg	15,3 kg
Art. no.	440572	440574	440573
Price	1125,-	1219,-	1255,-

- For roof awning F80S
- Consisting of side panels and front
- Material: Polyester
- Mounting side panels with FastClip
- Front window roll up, with mosquito net
- Side windows with blackout and mosquito net
- Incl. Bag Megabag light (140x25x25 cm)
- Incl. Curtains for front windows
- Door usable left and right
- Zippers connect front and side walls

\* Small and Large version for panel vans incl. magnet kit, consisting of 2 magnet sets of 6 magnets each.



Extension to A	Front panels	Front extension sets, suitable for all basic models	
320 cm	F: 20 cm	440497	48,-
340 cm	H: 40 cm	440577	52,-
370 cm	N: 70 cm	440578	64,30
400 cm	P: 100 cm	440501	103,-
425 cm	Q: 125 cm	440502	120,-
450 cm	T: 150 cm	440575	146,-

\*\* Version without magnets for vehicles with straight side walls.

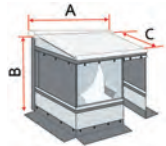

Basic model



Front extension sets



H, N

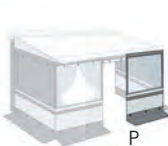

P

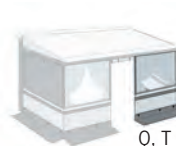

Q, T

#### Scope of delivery basic model:

Front part with window and curtains, 2 side panels, pegs.

#### Accessories:

Curtains, 1 pair, Dark Grey **440486 76,90**  
 Curtains, 3 pairs, Dark Grey **440487 193,-**  
 Wind screens: Page 185

The Privacy ROOM Light for wall awnings can be found on page 147



Magic Kit Privacy

#### Telescopic Reinforcing rods

Reinforce awning supports for awnings tents

##### Magic Kit Privacy Front Short

for Privacy 260 to 360 & 450

**44410 130,-**

for Privacy 400, 410 & 440

**44411 164,-**

for Privacy 500 & 550

**44412 186,-**

##### Magic Kit Privacy Side

**44413 80,90**



Press-rod

#### Pressure bars

Vertical pole to support the awning Privacy on the wall of the vehicle. To be ordered separately with Privacy Room Light and Privacy Room CS Light.

**E3542 84,50**



#### Door Pole vertical door pole for better support of front wall in door area.

for Fiamma F80S, F80L

**440443 55,-**

for Fiamma F65

**444090 43,70**



# Fiamma F45S

## Wall awning for compact vans



### The Awning for motorhomes, caravans and camper vans with 2 piping rails

- Extra-strong, lightweight aluminum housing with aluminum end caps and 2 keder rails
- Maximum shaded area, cloth with diffuse light distribution
- Vinyl cloth printed on both sides with anti-scratch coat as a protective film
- Regulation system for closing the front panel
- Self-locking auto-lock safety mechanism
- Support feet integrated in the front panel
- Special mounting adapters available for various vehicles
- 12 V motor can be retrofitted as an option

#### Accessories for Fiamma F45S:

Fiamma mounting adapters for special mounting situations	Page 144-145
Fiamma front and side walls	Page 155-157
Fiamma awnings	Page 146-149
Fiamma tension rods	Page 160
Fiamma sealing rubbers	Page 161

#### Fiamma F45S with 2 front keder rails

Type	260	300	325	350	375	400	425	450
Awning width A	263 cm	308 cm		348 cm	375 cm	398 cm	423 cm	448 cm
Fabric width B	247 cm	292 cm		331 cm	357 cm	381 cm	406 cm	431 cm
Pull-out C	200 cm	250 cm	250 cm	250 cm	250 cm	250 cm	250 cm	250 cm
Weight	19,5 kg	23,0 kg	24,0 kg	25,0 kg	26,0 kg	27,0 kg	28,2 kg	29,5 kg

#### Housing Polar White

Royal Grey	4376217	437687	—	437697	437705	437707	437709	437717
Royal Blue	4376218	437688	—	437698	437710	437708	437711	437718
Price	819,-	899,-	—	992,-	1050,-	1067,-	1194,-	1194,-

#### Housing Titanium

Royal Grey	4376267	437727	—	437737	437745	437747	437755	437757
Royal Blue	4376268	437728	—	437738	437746	437748	437756	437758
Price	847,-	926,-	—	1013,-	1066,-	1099,-	1219,-	1219,-

#### Housing Deep Black

Royal Grey	4376991	4377001	437713	4377002	437704	437703	437706	437712
Price	847,-	926,-	969,-	1013,-	1066,-	1099,-	1219,-	1219,-

**Scope of delivery:** awning crank, support foot attachment to the wall and pegs.  
For awning width 400 cm and 450 cm incl. aluminum tensioning rod Rafter.



Reinforced bracket of the support feet.



Rain gutter in the front panel diverts rainwater runoff to the sides.



Dual-shock absorbers on support arms absorb wind movements, e.g., and thus protect awning & vehicle.



Double keder rail to accommodate accessories such as hook set, Tiedown S storm bracing, Sun/Rain Blocker or Privacy Room.



Cable channels integrated into the support arms ensure perfect attachment of accessories such as LED lighting.



# Fiamma F45L

## Wall awning for compact vans

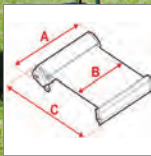

### Awning mounting

Mounting plates are already included in the scope of delivery for the side wall awnings. These are suitable for mounting awning on a smooth wall surface, e.g. on a motorhome with a sandwich body or on a high roof. However, some manufacturers equip their vehicles w/ raised profile edges or other attachments that make mounting w/ the supplied plates impossible. In this case, an appropriate vehicle adapter can help.

### Large folding arm awnings with sturdy aluminum end caps and 2 keder rails

Fiamma F45L with mounting plates for the side wall			
Type	450	500	550
Awning width A	452 cm	502 cm	552 cm
Fabric width B	435 cm	485 cm	535 cm
Pull-out C	250 cm	250 cm	250 cm
Weight	39,0 kg	42,5 kg	46,5 kg

- Equipment like F45S
- Widths from 450 cm to 550 cm
- Perfect fabric tension thanks to roller support
- Optionally, a 12 volt motor can be retrofitted

Housing Polar White			
Royal Grey	425007	425027	425047
Royal Blue	425008	425028	425048
Price	1491,-	1709,-	1859,-

Housing Titanium			
Royal Grey	425017	425037	425057
Royal Blue	425018	425038	425058
Price	1521,-	1753,-	1898,-

Housing Deep Black			
Royal Grey	440450	440451	440452
Price	1521,-	1753,-	1898,-

### Accessories for Fiamma F45L

Fiamma mounting adapter for special mounting situations	Page 144-145
Fiamma front and side walls	Page 155-157
Fiamma awning PrivacyRoom	Page 146
Fiamma tie rods	Page 160

### Scope of delivery of F45L

Awning crank, support foot attachment to the wall and by pegs. For awning width 450 cm to 550 cm, an aluminum tensioning rod Rafter is included.

### Awning motors for F45S and F45L

- Now new with smaller dimensions
- 12 volt motors for retrofitting
- Emergency operation by hand is possible
- Control unit "Control System" for motor mounting included in scope of delivery

The motor kits for F45S, F45L are mounted on the side of the awning instead of the existing awning gearbox. The Advanced version can be controlled via mobile. This increases width of awning by 13 cm. If no power is available, emergency operation by hand crank is still possible.

#### Motor Kit Compact



Motor kit F45L now also in black

#### Advanced motor kit



Engine kit F45S Compact Polar White	436308	527,-
Engine kit F45S Compact Titanium	436309	527,-
Engine Kit F45S Compact Deep Black	436310	527,-
Engine kit F45S Compact Polar White RHD*	436311	527,-
Motor kit F45S Advanced Polar White	440467	714,-
Engine kit F45S Advanced Titanium	440468	714,-
Motor kit F45S Advanced Deep Black	440466	714,-
Motor kit F45L Compact Polar White	436312	552,-
Engine kit F45L Compact Titanium	436313	552,-
Motor kit F45L Compact Deep Black	440586	552,-
Motor kit F45L Advanced Polar White	436314	722,-
Engine kit F45L Advanced Titanium	436315	722,-
Motor kit F45L Advanced Deep Black	440587	722,-

\* Right Hand Drive Version



The scope of delivery of all motor kits also includes a control unit.



# AWNINGADAPTER FOR F45S AND F45L

## F45 wall mounting adapter for panel vans and buses

### Multirail adapter

Special adapter for the REIMO Multirail, also for folding sleeping roofs. Black brackets for mounting the F45 to the Multirail. Awning and adapter are removable without affecting the appearance of the vehicle.  
ATTENTION: only mountable w/ existing Multirail.

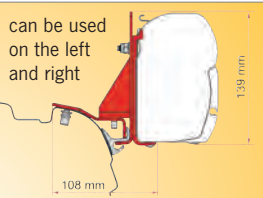

#### VW T5 / T6 / T6.1

For REIMO Multirail rain gutter. 2 black holders 8 cm each.  
440534 127,-

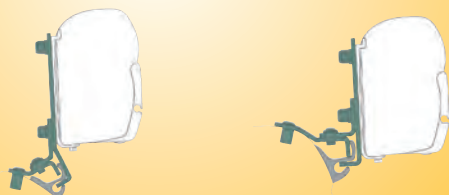

**Citroën Spacetourer**  
and similar to REIMO Multirail. For L2/L3. Removable.  
426770 185,-

#### VW T5 / T6 / T6.1

Mounting on REIMO Multirail. For KR and LR. Removable.  
426768 185,-

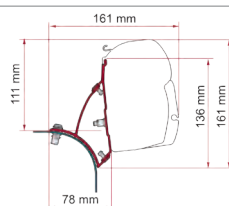

#### VW T5/T6 sleeper roof

For vehicles with pop-up roof. 2 holders à 21.5 cm.  
right 440599 107,-  
left, (UK) 440601 107,-

Bonding necessary.



#### VW T5/T6

Transporter or Multivan without C-profile.  
2 silver holders 21.5 cm:  
right E4631 110,-  
left, (UK) E4830 113,-  
2 black holders 21.5 cm:  
right 440705 126,-  
left, (UK) 440706 126,-

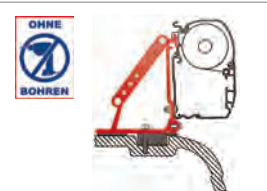

#### VW T5/T6

Screwing into the existing mounting points, no gluing necessary. Not for C-rail. 2 holders 12 cm each.  
E6413 113,-

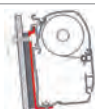

#### Westfalia high roofs

For Westfalia high roofs w/ awning preparation. 2 holders 12 cm each.  
43483 49,-



#### VW T4

With Brandrup-Rain gutter or REIMO Multirail. 2 holders à 8 cm  
433201 112,-

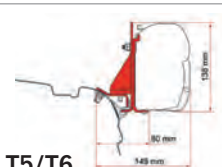

#### VW T5/T6

For Brandrup gutter. 2 black holders 12 cm each.  
440525 99,-

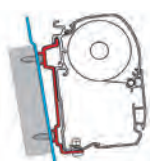

**Ford Transit**  
Ford Transit > 7/06 w/ standard high roof. 2 holders à 40 cm  
43456 85,-

#### F45S



**Ford Transit H3**  
Ford Transit length L3+L4. 2 holders à 25 cm and 1 x 8 cm.  
right 440595 188,-  
left, (UK) 440596 188,-



**Ford Custom Nugget**  
Ford Custom Nugget 2015-2023, H1/L1 with sleeper roof. 2 black holders 8 cm each.  
434563 257,-

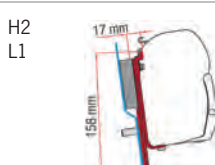

**Ford Custom Nugget < 2023**  
Ford Custom Nugget with high roof. 2 holders à 12 cm  
434561 95,-

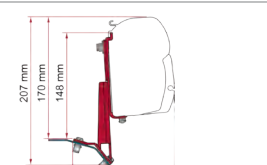

#### Ford Custom < 2023

2 holders à 12 cm  
right 440602 195,-  
left, (UK) 440603 195,-



**Ducato/Boxer/Jumper**  
1994 - 6/06 for standard high roof, 2 holders of 8 cm each. Bonding necessary.  
43324 97,50

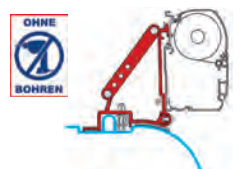

**Ducato/Boxer/Jumper**  
> 7/06 for standard high roof H2, 2 holders 8 cm each. Bonding necessary.  
43316 101,60

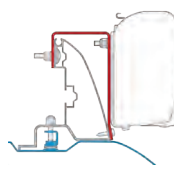

**Ducato/Boxer/Jumper**  
> 7/06 for standard high roof H2 w/ Roof Rail, 3 holders à 12 cm  
44405 95,60



**Ducato/Boxer/Jumper**  
> 7/06 with Roof Rack, 3 holders 12 cm each  
43355 88,80

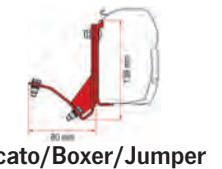

**Ducato/Boxer/Jumper HymmerCar and Pössl**  
For vehicles >07 w/ standard high roof H2 & folding sleeper roof. 3 holders 12 cm each  
444051 181,-

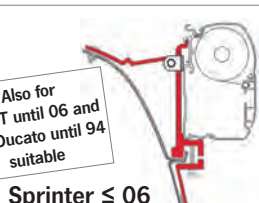

**Sprinter ≤ 06**  
For Sprinter < 6/06. With holder for the rain gutter. 2 holders à 8 cm  
43311 126,-

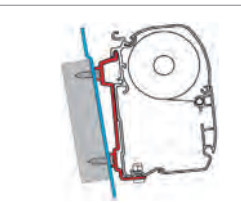

**Sprinter / Crafter**  
> 7/06 with high roof. 2 holders à 40 cm  
43456 85,-

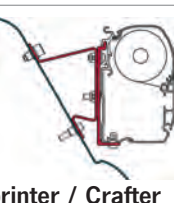

**Sprinter / Crafter**  
> 7/06 with high roof H3. Also for Westfalia high roof H3. 3 holder à 8 cm  
43477 106,-



**Mercedes Vito ≤ 2003**  
For Vito compact w/ original Mercedes roof rack. 2 holders à 14 cm  
43317 162,-

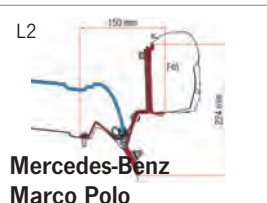

**Mercedes-Benz Marco Polo**  
Mercedes Marco Polo >14. Manual sleeping roof only. 2 holders (1x12 cm/1x13 cm)  
433413 249,-

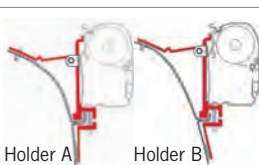

**For vans with rain gutter**  
In set with holder A + B. 2 holders of 8 cm.  
43311 126,-

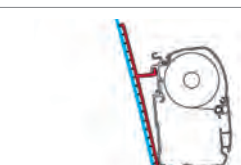

**GRP roofs**  
For gluing. Especially for high roofs of Mercedes, VW, Renault+Opel, 2Holder à 40 cm  
43460 134,-

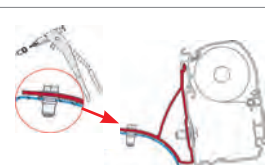

**Traffic/Vivaro < 2015**  
For wheelbase L1 and L2 with awning F45s 260 cm. 2 holders of 16 cm.  
43313 99,-

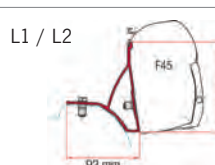

**Renault Traffic, Opel Vivaro, Fiat Talento > 2015**  
2 holders of 16 cm.  
433133 99,40

**F45 Wall mounting adapter for motorhomes & caravans**

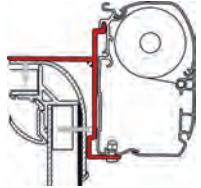

**Adria / Bürstner**  
ADRIA Coral up to 4 m awning length & various Bürstner vehicles. 3 holders à 15 cm / 1 holder à 12 cm  
**433903 84,50**

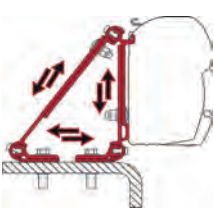

**Multi adapter**  
Multi roof adapter, 1 holder à 8cm  
**SA691 62,20**

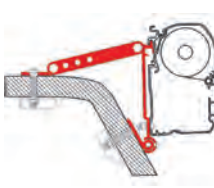

**Wall adapter**  
Universal wall adapter, 3 holders à 8cm  
**43397 96,60**

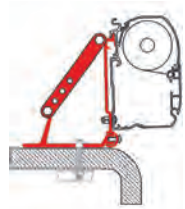

**Roof adapter**  
Universal roof adapter, 3 holders à 8 cm  
**43389 107,-**

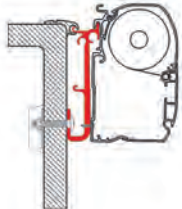

**Caravan keder rail**  
Various mounting options 3 mounting plates à 13 cm  
**43319 78,50**

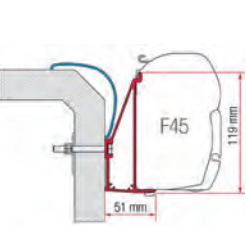

**Rapido Series 6 < 24**  
Adapter rails for Eura and Karman vehicles  
350 cm **E1104 338,-**  
400 cm **434762 355,-**

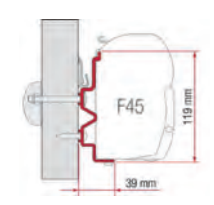

**Rapido Series 9dF-9M-10 > 2011**  
350 cm **43474 328,-**  
400 cm **E1105 357,-**  
450 cm **434742 381,-**

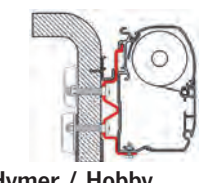

**Hymer / Hobby**  
Hymer C-Class Swing, Star Line, Hobby Van and Caravan 09.  
300 cm **43327 223,-**  
350 cm **43333 245,-**  
400 cm **43336 292,-**  
450 cm **433361 308,-**

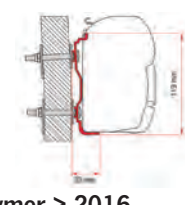

**Hymer > 2016**  
Kit, 3 holders à 12 cm  
300 cm **44480 101,-**  
350 cm **44475 219,-**  
400 cm **44476 243,-**  
450 cm **44477 265,-**  
450 cm **44478 312,-**

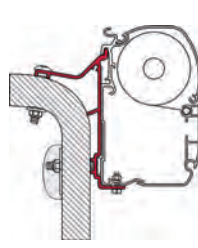

**Hymer**  
Hymer VAN / B2  
350 cm **43349 236,-**  
400 cm **433410 268,-**  
450 cm **433491 327,-**

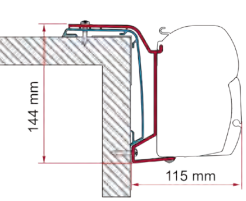

**Rapido Series 6 > 24**  
Adapter rails  
400 cm **440597 352,-**  
500 cm **440598 387,-**

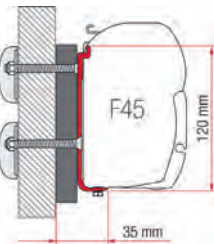

**Dethleffs/Globebus**  
Universal wall adapter, 3 holders 12 cm each  
**433931 89,-**

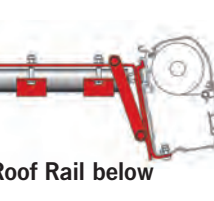

**Roof Rail below**  
**For roof rack**  
Fits most trusses. For awning mounting are required min. 2 kits needed. 1 holder à 12 cm  
**43368 126,-**

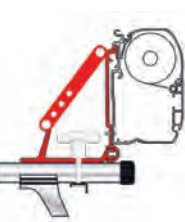

**Car adapter top**  
For mounting on the support tube of the roof rack.  
2 piece  
**43398 95,-**

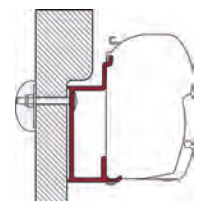

**Eura Mobil / Karmann**  
Adapter rails for Eura and Karman vehicles  
350 cm **434571 299,-**  
400 cm **SA600 339,-**  
450 cm **SA598 368,-**

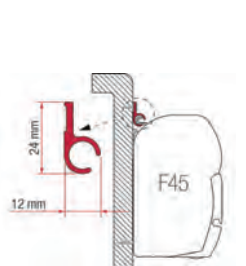

**Rail**  
Length 400 cm  
**E6019 39,90**

**Wall bracket for smooth, vertical motorhome and caravan walls**



**Kit S 120**  
Single holder 1 holder à 12 cm + accessories.  
**43481 21,-**



**Kit AS 120 holder set**  
2 holders à 12 cm, 1 holder à 8 cm + accessories.  
Series at 260-400 cm  
**43480 49,-**



**Kit S 400 single holder**  
1 holder à 40cm + accessories.  
**43482 41,-**



**Kit AS 400 holder set**  
2 holders à 40cm 1 holder à 12cm + accessories.  
Series at 450-500 cm  
**434821 101,-**



**AS 300 Complete rail**  
300 cm **43335 187,-**

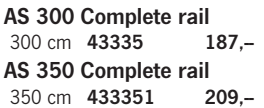

**AS 350 Complete rail**  
350 cm **433351 209,-**

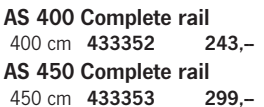

**AS 400 Complete rail**  
400 cm **433352 243,-**



**AS 450 Complete rail**  
450 cm **433353 299,-**

**i Standard SOD**  
for F45S/F45L

- up to 4.00 m width 2 holders à 12 cm + 1 holder à 8 cm.
- 4.50 m width up to 5.00 m width 2 holders à 40 cm + 1 holder à 12 cm
- 5.50 m width 4 holders à 40 cm

**Modular fasteners for F45**

114 mm  
18 mm

**Ideal for mounting on the high roof**

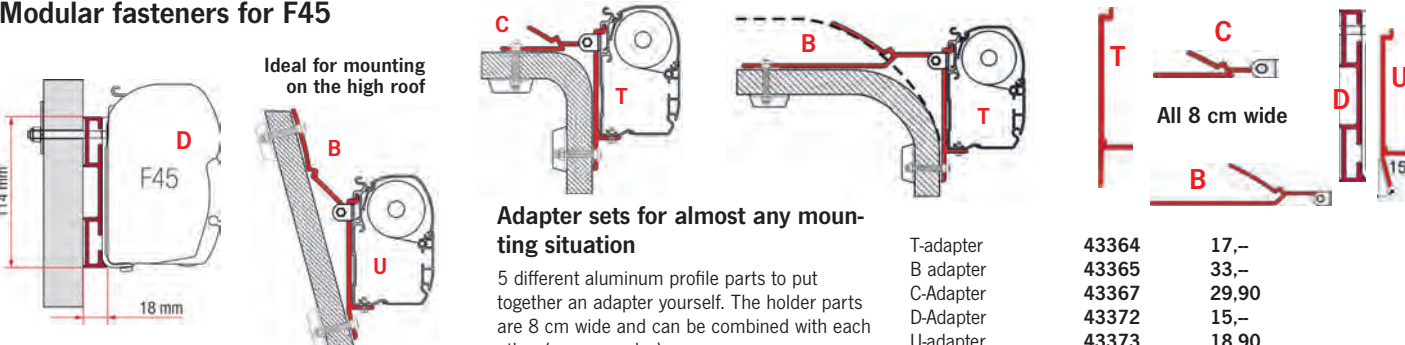

**Adapter sets for almost any mounting situation**  
5 different aluminum profile parts to put together an adapter yourself. The holder parts are 8 cm wide and can be combined with each other (see examples).

T-adapter	43364	17,-
B adapter	43365	33,-
C-Adapter	43367	29,90
D-Adapter	43372	15,-
U-adapter	43373	18,90

All 8 cm wide



## Fiamma Privacy Room



Also for panel vans & buses

Privacy Room for roof awnings can be found on page 140

### Privacy ROOM for F45S and F45L - awning without awning

Basic model	Small (A = 260 cm) Height B = 180 - 220 cm Pull-out C = 200 cm		Medium (A = 300 cm) Height B = 225 - 250 cm Pull-out C = 250 cm		Large (A = 300 cm) Height B = 251 - 280 cm Pull-out C = 250 cm	
	435300	1351,-	435301	1347,-	435302	1366,-

Extension to awning width	Front panels	Front extension sets to increase the width					
		300 cm	325 cm	350 cm	375 cm	400 cm	425 cm
300 cm	L: 40 cm	436626	82,-				
325 cm	T: 25 cm			435314	55,20	435314	55,20
350 cm	N: 50 cm			435311	61,-	435311	61,-
375 cm	P: 75 cm			435312	78,70	435312	78,70
400 cm	Q: 100 cm			436623	121,-	436623	121,-
425 cm	R: 125 cm			436624	150,-	436624	150,-
450 cm	U: 150 cm			436625	173,-	436625	173,-
500 cm	W: 200 cm			435313	207,-	435313	207,-
550 cm	N+W 50+200 cm					+ 435311 435313	61,- 207,-

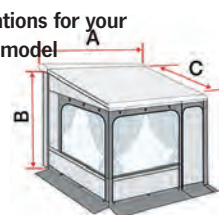
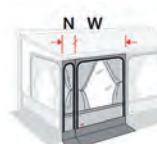
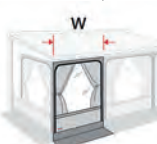
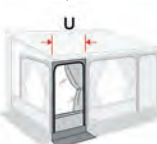
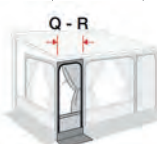
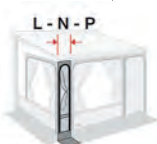

### The robust Awning

- Consisting of side panels and front
- Material: Vinyl
- Mounting side panels with FastClip
- Front window roll up, with mosquito net
- Side window roll up, with mosquito net
- Incl. Bag Megabag (140 x 27 x 40 cm)
- Incl. Curtains for all windows
- Door usable left and right
- Zippers connect front and side walls
- Also suitable for Thule Omnistor 5002 & 5003 with optional kit Privacy O (E4263)

Scope of delivery basic model: Front part w/ door & window, curtains, two side walls w/ window & mosquito net, clip system profile.

#### Accessories:

Curtains, 1 pair, Dark Grey	440486	76,90
Curtains, 3 pairs, Dark Grey	440487	193,-
Kit Privacy O	E4263	45,70

for mounting on Thule awning

Wind screens: Page 185

#### Dimensional designations for your Privacy Room basic model

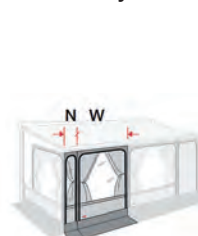

## Fiamma Privacy Ultra Light



### Privacy ULTRA Light for F45S and F45L - Awning awning without awning

Type	Width awning	Mounting height (B) 180-220 cm		Mounting height (B) 230-280 cm	
		Weight	Price	Weight	Price
UL Van 260	260 cm	12,3 kg	43595 1192,-		
UL 300	300 cm, 320 cm			14,2 kg	435950 1239,-
UL 350	350 cm, 370 cm			15,4 kg	435951 1276,-
UL 400	400 cm			16,6 kg	435952 1386,-
UL 450	450 cm			17,8 kg	435953 1428,-

### The Quick-assembly awning awning

- One-piece, underhung tent made of side panels, front and roof
- Material: Polyester Ripstop
- Mounting with transverse frame
- Front window fixed, front panel removable
- Side windows with blackout and mosquito net, side walls can be opened
- Incl. Bag Megabag light, for UL 400 with bag Megabag
- Incl. Curtains for front windows

Scope of delivery Tent consisting of roof, front and side walls, mounting kit for Fiamma awnings, cross-rafters with tension straps with pegs and transport bag.

#### Accessories

Curtains, 1 pair, Dark Grey	440486	76,90
Curtains, 3 pairs, Dark Grey	440487	193,-
Windshields		Page 185



## Fiamma Privacy Room Light The lightweight awning awning



### Privacy ROOM Light for F45S - Awning without awning

Basic model	Small (Van) A = 260 cm B = 180 - 220 cm C = 200 cm	Medium A = 300 cm B = 225 - 250 cm C = 250 cm	Large A = 300 cm B = 251 - 280 cm C = 250 cm
Weight	12,0 kg	14,4 kg	14,7 kg
Art. no.	440494	440495	440496
Price	1026,-	1026,-	1038,-

- Consisting of side panels and front
- Material: Polyester
- Mounting side panels with FastClip
- Front window roll up, with mosquito net
- Side windows with blackout and mosquito net
- Incl. Bag Megabag light (140x25x25 cm)
- Also suitable for vans
- Incl. Curtains for front windows
- Door usable left and right
- Zippers connect front and side walls
- Also suitable for Thule awnings with optional kit Privacy O (E4263)

#### Scope of delivery basic model:

Front part with window and curtains, 2 side panels, pegs.

#### Accessories:

Curtains, 1 pair, Dark Grey **440486 76,90**  
Curtains, 3 pairs, Dark Grey **440487 193,-**

**Kit Privacy O E4263 45,70**

for mounting on Thule awning

Wind screens: Page 185

Extension to A	Front panels	Front extension sets to increase the width					
300 cm	X: 40 cm	440571	52,10				
325 cm	Z: 25 cm			440498	46,20	440498	46,20
350 cm	I: 50 cm			440499	52,10	440499	52,10
375 cm	O: 75 cm			440500	64,30	440500	64,30
400 cm	P: 100 cm			440501	103,-	440501	103,-
425 cm	Q: 125 cm			440502	120,-	440502	120,-
450 cm	T: 150 cm			440575	146,-	440575	146,-
500 cm	K: 200 cm			440576	195,-	440576	195,-
550 cm	K+I: 250 cm			440499	52,10	440499	52,10

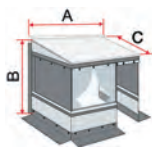

Basic model



X, Z



I, O, P



Q, T, K

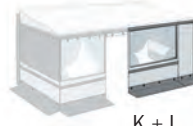

K + I

Front extension sets



Magic Kit Privacy

#### Telescopic reinforcement bars

Reinforce awning supports for awnings tents

##### Magic Kit Privacy Front Short

for Privacy 260 to 360 & 450

**44410**

**130,-**

for Privacy 400, 410 & 440

**44411**

**164,-**

for Privacy 500 & 550

**44412**

**186,-**

##### Magic Kit Privacy Side

**44413**

**80,90**



Press-rod



**TIP**

#### Pressure bars

Vertical pole to support the awning Privacy on the wall of the vehicle. To be ordered separately with Privacy Room Light and Privacy Room CS Light.

**E3542**

**84,50**





Fiamma ZIP  
Fiamma F45 with optional Awning



ZIP S



ZIP L



Detail

- Assemble awning based on F45 and complete awning
- Side sections are connected to the awning fabric with zippers
- All Crystal windows can be opened.
- Increased tightness against wind
- The door in the front can be mounted on the left or right side
- The fastening system (Rapid Set) stabilizes the awning
- Tight connection to vehicle through padded bar

**Scope of delivery:** Awning based on F45 incl. mounting brackets/adapters, front & side panels, ZIP zipper system, Crystal window roll-up, standard w/ mosquito net & curtains, Rapid Set mounting system & Rafter tensioning pole, Skirting windshields, tensioning straps, hooks & Mega Bag for privacy & poles

**Accessories for Fiamma ZIP:**

Additional tie rods	see page 160
Curtains, 1 pair	<b>440486 76,90</b>
Curtains, 3 pair	<b>440487 193,-</b>

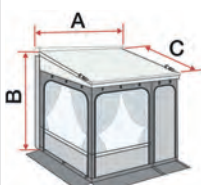

Basic model

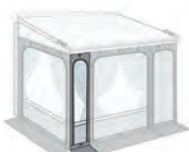

①

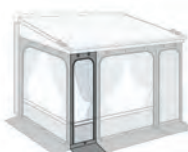

②

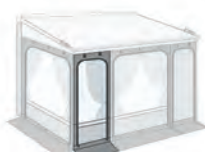

③

**How to order the Fiamma ZIP with matching awning**

Choose the length of the awning below according to your needs. Attention: These are special awnings. The normal F45 does not fit.

Order the basic awning model, which is designed for a mounting height of the awning between 225 and 250 cm, and complete the remaining width with the specified front panel extensions.

1. Select awning							+ 2. Order awning basic model in addition			+ 3. Front extension		
Awning model	(A) Total width	(C) Pull-out	Weight	Color Royal Grey	Color Royal Blue	Price	Awning basic model	Item no.	Price	Order extension front panels	Item no.	Price
Fiamma ZIP Housing White												
ZIP 300 (F45S)	306 cm	250 cm	23,5 kg	434051	434052	1066,-	Privacy Room M B: 225 - 250 cm A: 300 cm	434037	1559,-	—		
ZIP 350 (F45S)	356 cm		23,5 kg	434053	434054	1126,-				① 50 cm	435311	61,-
ZIP 400 (F45L)	406 cm		36,5 kg	434055	434056	1513,-				② 100 cm	436623	121,-
ZIP 450 (F45L)	456 cm		36,5 kg	434057	434058	1752,-				③ 150 cm	436625	173,-



**Special awning**

- With matching adapter
- Double piping on front profile
- Awning width 263/308 cm
- Fabric width 247/292 cm
- Extension: 200 cm
- Weight: 19.5/22.0 kg

Suitable for: Volkswagen Transporter 5/6 Multivan and California with Volkswagen rails



**Accessories**

Awning **Privacy Room** for Volkswagen Transporter 5 KR Special awning, consists of: Front part, 2 side parts. Fast construction with Fast Clip System Page 146  
Special sealing rubber Page 159



Fiamma F45S Special awning for Volkswagen Transporter 5/6/6.1

**Side wall awning incl. adapter for Volkswagen Multivan**

For mounting on original Volkswagen rails on the roof.

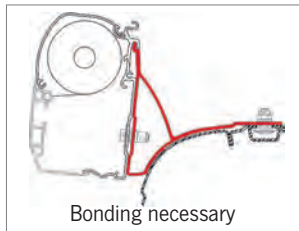

**Awning (width 260 cm) for Volkswagen Multivan KR**

Royal Grey, Housing Titanium	<b>4376730</b>	<b>888,-</b>
UK version	<b>4376740</b>	<b>888,-</b>
Royal Grey, Housing Deep Black	<b>4376780</b>	<b>888,-</b>
UK version	<b>4376782</b>	<b>888,-</b>

Bonding necessary



**Awning (width 300 cm) for Volkswagen Multivan LR**

Royal Grey, Housing Titanium	<b>E46270</b>	<b>917,-</b>
UK version	<b>4376742</b>	<b>917,-</b>
Royal Grey, Housing Deep Black	<b>E10168</b>	<b>917,-</b>
UK version	<b>4376783</b>	<b>917,-</b>

**Side wall awning incl. adapter for Volkswagen California**

For California with sleeper roof and side Volkswagen Keder rail.

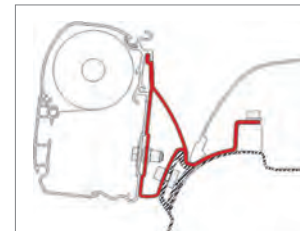

**Awning (width 260 cm) for Volkswagen California**

Royal Grey, Polar White case	<b>4376709</b>	<b>876,-</b>
Royal Grey, Titanium case	<b>4376710</b>	<b>877,-</b>
Royal Grey, Housing Deep Black	<b>4376760</b>	<b>877,-</b>



**Awning set F45S**

- Awning F45S in width 260 cm
- Incl. vehicle-specific adapter

Suitable for: Citroën Spacetourer/Jumpy ≥ 2016 Peugeot Traveller/Expert ≥ 2016 Toyota Proace (Verso) ≥ 2016 Fiat Scudo ≥ 2016 Opel Zafira D/ Vivaro ≥ 2019

**Scope of delivery:** Awning, adapter & crank handle

**PPE set F45s White**

Housing color: Polar White,  
Fabric color: Royal Grey  
**437680 901,-**

**PPE set F45s Black**

Housing color: Deep Black,  
Fabric color: Royal Grey  
**437681 920,-**



Fiamma F45S special awning for PSA compact vans

Accessories for Fiamma F45S: Front and side walls page 155-157



Fiamma F43van  
Special awning for buses



Wall awning F43van

- Crank with magnetic lock
  - Low housing, especially for buses with and without pop-up roof
  - Negative fabric inclination for flat Vehicles
  - LED device in 2 piping rails
- Royal gray fabric, deep black housing.  
Mounting adapter required.

F43van	270	300
Awning width	270 cm	310 cm
Fabric width	257 cm	287 cm
Pull-put	225 cm	250 cm
Weight	19,0 kg	21,5 kg
Item no.	440545	440546
Price	815,-	890,-



Bonding necessary

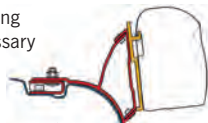

**VW T5/T6 kR**  
Transporter/Multivan without C-profile.  
2 black holders, 21.5 cm each.  
Mounting on the vehicle  
right **440707 126,-**  
left (UK) **440708 126,-**



**VW T5 / T6 / T6.1**  
Lift Roof. kR + IR.  
2 black holders, 21.5 cm each.  
Mounting on the vehicle  
right **440709 107,-**  
left (UK) **440710 107,-**



**VW T5 / T6 / T6.1**  
**California**  
2 black holders 12 cm each.  
**440714 127,-**

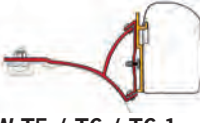

**VW T5 / T6 / T6.1 with C-rail (Multivan)**  
2 black holders à 12 + 21,5 cm.  
Mounting on the vehicle  
right **440716 127,-**  
left (UK) **440717 127,-**



**VW T5/T6 kR**  
For Brandrup gutter.  
2 black holders 12 cm each.  
**440525 99,-**



**VW T5 / T6 / T6.1 kR**  
For REIMO Multirail rain gutter.  
Even with pop-up roof  
2 black holders, 8 cm each.  
**440534 127,-**



**VW T4**  
With Brandrup rain gutter or REIMO Multirail. kR + IR.  
2 silver holders, 8 cm each  
**433201 112,-**



**VW T3**  
Bracket for the rain gutter. Also with pop-up roof.  
2 black holders, 8 cm each  
**43312 125,-**



**Ford Custom < 2023**  
**Lift Roof**  
kR + IR. Only open the awning when the sliding door is closed.  
2 black holders 12 cm each.  
Mounting on the vehicle  
right **440602 195,-**  
left (UK) **440603 195,-**



**Ford Custom Nugget < 2023**  
Ford Custom Nugget with H2/L2. 2 silver holders, 12 cm each  
**434561 95,-**



**Ford Custom Nugget**  
Ford Custom Nugget 2015-2023, H1/L1 with pop-up roof.  
2 black holders 8 cm each.  
**434563 257,-**



**PSA**  
2 black holders, 20 cm each.  
**440715 170,-**



**Mercedes-Benz Marco Polo**  
Mercedes-Benz Marco Polo long > 2014. Only for manual pop-up roof.  
2 silver holders à 12 + 13 cm  
**433413 249,-**



**Traffic/Vivaro < 2015**  
For L1 /L2  
2 silver holders, 16 cm each.  
**440713 90,-**



**Renault Trafic, Opel Vivaro, Fiat Talento > 2015**  
kR + IR.  
2 silver holders, 16 cm each.  
**440712 88,-**



**Matching awning canopies on the right-hand side**



**Car Adapter top**  
For mounting on the support tube of the roof rack.  
2 silver holders, 8 cm each  
**43398 95,-**



**Westfalia high roofs**  
For Westfalia high roofs w/ awning preparation.  
2 silver holders, 12 cm each.  
**43483 49,-**

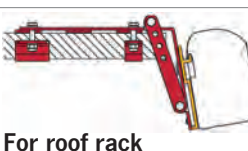

**For roof rack**  
Fits traverses w/ a maximum width of 55 mm.  
For awning installation, min. 2 holders are required. 1 silver holder à 12 cm  
**43368 126,-**



**Mercedes-Benz Vito < '03**  
For Vito compact with original Mercedes roof rack. 2 silver holders 14 cm each  
**43317 162,-**



**Roof awning F40van** Reinforced folding

arms

- Mounting with deep-seated adapters
- Space-saving, reduced protrusion

Suitable for: Volkswagen Transporter 5/6.

Fabric Royal grey, case Deep Black.

Mounting adapter required.

F40van	210	270
Awning width	210 cm	270 cm
Fabric width	199 cm	257 cm
Pull-put	150 cm	225 cm
Weight	17,0 kg	19,0 kg
Item no.	440547	44364
Price	881,-	960,-

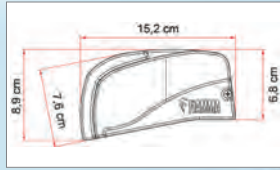

**Fiamma F40 van**  
Special awning for buses



**Mounting adapter for F40van**

For Volkswagen Transporter 5/6 and Multivan without C-rail in the roof

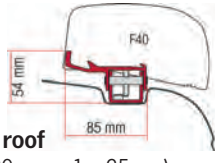

2 holders in black (1 x 20 cm + 1 x 25 cm) short wheelbase

- Incl. Kit upgrade **440530** 116,-
- short wheelbase UK version Incl. Kit upgrade **440531** 116,-
- short wheelbase UK version **443651** 114,-

For Volkswagen Transporter 5/6 and Multivan with C-rail in the roof

2 black holders à 20 cm (not shown) **kR + IR (also UK)** **440618** 112,-

For Ford Custom <2023

- 2 black holders short wheelbase **44336** 248,-
- short wheelbase UK version **443000** 248,-
- long wheelbase (also UK) **44339** 239,-



- Mounting on existing roof points
- Can be dismantled again at any time
- No drilling, no gluing



For Nissan Black holder



- NV 200** **436357** 154,-
- NV 350** **436358** 154,-



For PSA 260 Van

Citroën Spacetourer, Peugeot Traveller, Toyota Verso and the like. Black. **443371** 382,-

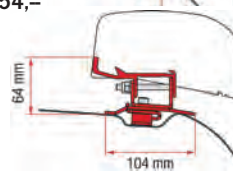

For Mercedes-Benz V-Class > 2014

2 black holders (1 x 39 cm + 1 x 22 cm) **44337** 301,-



For Renault Trafic > 2014

2 black holders short wheelbase (also UK) **44349** 211,-

long wheelbase (also UK) **44338** 288,-

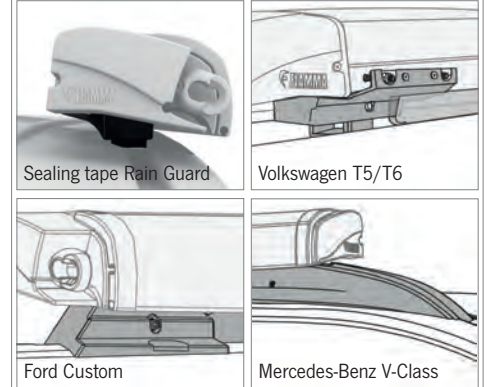
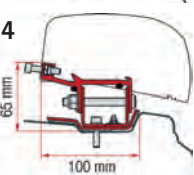

**Rain Guard sealing tape for F40 van**

Provides a seal between the awning and the Vehicle roof. An ideal extra to the adapter.

Volkswagen Transporter 5/6	<b>433884</b>	155,-
Ford Custom kR	<b>433006</b>	160,-
Ford Custom kR (UK version)	<b>433005</b>	160,-
Ford Custom IR	<b>433008</b>	160,-
Ford Custom IR (UK version)	<b>433007</b>	160,-
Mercedes-Benz V-Class	<b>433009</b>	182,-

**Room Van complete awning tent for F40 van + F43 van**

- No additional linkage
- Ripstop material - lightweight & tear-resistant
- Incl. Pannier
- Mounting height 180-210 cm

**Room Van Premium.** Side sections with roll-up windows and mosquito net, front with door, weight 5.4 or 5.8 kg.

**B 300 cm** **440579** 987,-





# Fiamma F35pro

## For Buses, vans and small caravans



### F35PRO for vans - Titanium housing

Wide	Pull-put	Weight	H <sub>max.</sub> front	Royal Grey	Royal Blue	Price
180 cm	180 cm	8,5 kg	195 cm	43775	43770	509,-
220 cm	225 cm	10,5 kg	225 cm	43776	43771	559,-
250 cm	225 cm	11,5 kg	225 cm	43777	43772	581,-
270 cm	225 cm	13,0 kg	225 cm	43778	43773	583,-
300 cm	225 cm	14,0 kg	235 cm	43779	43774	607,-

- Housing in deep black or Titanium
- Robust, anodized aluminum housing
- Practical roller blind pullout
- The double keder rail allows two front parts or accessories to be retracted at same time
- Lightweight, compact and quick to open and close
- Support feet lie in the awning tube
- Extensive range of accessories

### F35PRO for Vans - Deep Black housing

Wide	Pull-put	Weight	H <sub>max.</sub> front	Royal Grey	-	Price
180 cm	180 cm	8,5 kg	195 cm	43721	-	509,-
220 cm	225 cm	10,5 kg	225 cm	43729	-	559,-
250 cm	225 cm	11,5 kg	225 cm	43780	-	581,-
270 cm	225 cm	13,0 kg	225 cm	43781	-	583,-
300 cm	225 cm	14,0 kg	235 cm	43735	-	607,-

**Scope of delivery:** Awning in housing, pegs and lines for fastening to the ground.

#### Accessories for Fiamma F35

Vehicle adapter	right side
Front and side walls	Page 155-156
Awning PrivacyRoom CS Light	Page 154



**Adapter Kit Car**  
for roof racks.  
2 holders à 8 cm  
43398 71,40

### Compact awning

- Mounting on the roof rack
- Practical roller blind pullout
- Support feet lie in the awning tube

Suitable for: Volkswagen Caddy, Citroën Berlingo and Co.

FIAMMA F35 Pro with a width of 180 cm is ideal for small vehicles. Weighing only 8.5 kg and extending 180 cm, it provides a shaded area of 2.9 m<sup>2</sup>.

The assembly can be mounted on almost all roof racks with the specified adapter.  
Housing color: Titanium.

**Scope of delivery:** Awning, pegs and guy lines.

#### Awning width 180 cm

Fabric Royal Grey	43775	509,-
Fabric Royal Blue	43770	509,-

#### Awning width 220 cm

Fabric Royal Grey	43776	559,-
Fabric Royal Blue	43771	559,-

#### Accessories for Fiamma F35:

Front and side walls	Page 155-156
other mounting adapters	Page 153

### **i** Awning installation on Volkswagen Caddy & Co.

For mounting, there are universal adapters, e.g. for roof racks, or vehicle-specific adapters adapted to individual vehicles. You can find the adapters on the right side or ask your dealer.

**Awning widths:** For Volkswagen Caddy kR, Citroën Berlingo, Peugeot Partner and Ford Tourneo Connect up to YOC. in 2013, awning width 180 cm is recommended, for Volkswagen Caddy Maxi a width of 220 cm.



**Adapter for F35PRO**



**VW T5 / T6**  
Screwing to existing points, no gluing.  
Not for C-rail.  
2 holders 12 cm each.  
**E6413 113,-**



**VW T5 / T6**  
For Multivan or Transporter w/ roof rail. Gluing necessary. 2 holders 12 cm each.  
**43340 96,-**



**VW T5 / T6**  
For Multivan/Transporter w/o roof rail.  
Gluing necessary. 2 x 21,5 cm.  
right **433403 112,-**  
left, (UK) **433404 112,-**

**Multirail adapter**  
Special adapter for the REIMO Multirail, also for folding sleeping roofs.  
Black brackets for mounting the F35 Pro to the Multirail.  
Awning and adapter are removable without affecting the appearance of the vehicle.  
ATTENTION: only mountable w/ existing Multirail.

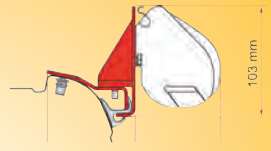

**VW T5 / T6 / T6.1** with REIMO Multirail rain gutter. Suitable for left & right hand drive. Removable.  
2 black holders 8 cm each.  
**440533 129,-**

**TIP**

**VW T5 / T6 / T6.1**  
Mounting on the REIMO Multirail. Suitable for KR + LR. Removable.  
**426768 185,-**

**Citroen Spacetourer** and similar to REIMO Multirail. For L2 / L3. Removable.  
**426769 179,99**



**Westfalia Kepler Volkswagen T6 LR**  
for L2, 2 holders of 10 cm.  
**433406 124,-**

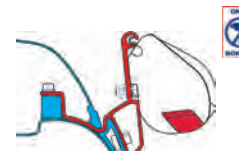

**VW T5 / T6 VW California.**  
2 holders à 12 cm  
**433401 101,-**



**VW T5 / T6** with Brandrup rain gutter. Suitable for left & right hand drive. 2 black holders 8 cm.  
**440532 113,-**



**VW T3**  
Adapter set for rain gutter mounting. 2 holders à 8 cm.  
**43441 96,-**

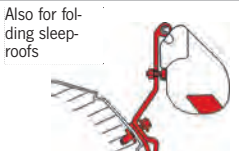

**VW T4**  
Adapter kit for flat roof mounting. 2 holders à 8 cm  
**43330 69,-**



**VW T4**  
For Brandrup gutters  
2 holders à 8 cm.  
**433201 112,-**



**VW Caddy Maxi** with pop-up roof, Black, 2016-2020, for awning width 220cm. 2 holders 12cm each.  
**433418 136,-**

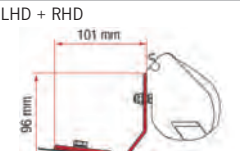

**VW Caddy Maxi**  
Black, 2016 - 2020, for awning width 220 cm. 2 holders à 8 cm.  
**433417 101,-**



**Citroën Spacetourer, Peugeot Traveller, Toyota Verso, Opel Zafira > 2019**  
2 holders à 20 cm  
**44329 145,-**

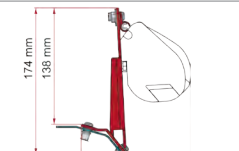

**ford Transit Custom**  
< 2023, 2 holders à 12 cm  
right **440602 195,-**  
left, (UK) **440603 195,-**



**Dreamer**  
Cap Land/Cap Fun  
Ford Transit Custom < 2023  
2 holders 12 cm each.  
**433416 125,-**



**Dreamer**  
Cap Coast (L1)  
Cap Land/Cap Life (L2)  
Ford Transit Custom < 2023  
2 holders à 12 cm  
**44335 132,-**



**Kit Ford Custom > 2024**  
for Groupe Rapido, dimensions 19x15x13 cm, H1 / L2  
**436359 83,20**

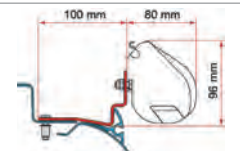

**Campérève Cap Road**  
on Peugeot Expert  
2 black holders 12 cm each.  
Suitable for left & right hand drive.  
**440529 68,-**



**Mercedes-Benz Vito < 2004.**  
2 holders à 8 cm.  
**43341 109,-**



**Mercedes-Benz Vito/Viano and V-Class**  
> 2014, 2 holders à 13 cm.  
Not with REIMO-SD.  
**433412 106,-**

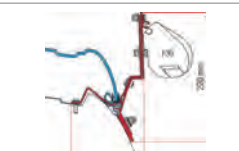

**Mercedes-Benz V-Class Marco Polo > 2014**  
1 holder à 12 cm and 1 holder à 13 cm.  
**433413 249,-**

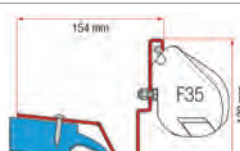

**Westfalia Jules Verne Mercedes-Benz Vito**  
2 holders 12 cm each.  
**433414 121,-**

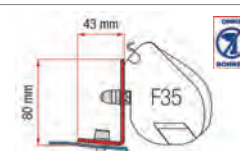

**Nissan NV200/Evalia**  
For awning width 220 cm.  
2 holders à 8 cm.  
**433415 112,-**



**Standard**  
2 holders à 8 cm.  
**43348 88,-**



**Eriba Touring**  
Adapter kit for Eriba Touring.  
2 holders à 8 cm  
**43366 99,-**



**Renault Trafic < 2015**  
2 holders à 12 cm  
**433131 89,-**



**Opel Vivaro > 2015**  
2 holders à 12 cm  
**433132 93,90**



Fiamma Privacy Room CS Light  
Awning awning for F35 pro



Window roll up, incl. mosquito net



Awning Tent Retrofit Kit for F35 Pro

Type	250 VAN	270 VAN	280	310
for awning	F35 (250 cm)	F35 (270 cm)	F35 (270 cm)	F35 (300 cm)
Mounting height	180-220 cm	180-220 cm	240-260 cm	240-260 cm
Weight	8,7 kg	9,1 kg	11,6 kg	11,8 kg
Accessories needed			Adapter 434743 (for mounting on F35 270)	Adapter 434743 (for mounting on F35 300)
Art. no.	440490	440491	440488	440489
Price	920,-	920,-	988,-	1010,-

Adapter for PrivacyRoom CS Light to F35 Pro      434743      18,-

More living space for the F35 PRO with awning retrofit kit

- With Fast Clip fastening system: aluminum profile made of two parts, into which the side sections can be pulled in more quickly.
- Connection to the vehicle wall by elastic tensioning straps
- Front retractable into the awning keder rail
- Connection front/side parts by zippers
- Door retractable left or right
- Windows of the front with curtains
- Windows of the side parts with mosquito nets
- Incl. Pannier Mega Bag light



Shade valance

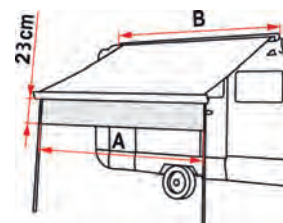

Practical valance for pulling into piping rail. Series at Caravanstore. Suitable for any awning with keder rail. Can be shortened to awning width.

Shade valance - Practical sun visor for F45, F35, F80, Caravanstore and more

Designation	F45	F45L	F43	F40	F80s	F80L	F65	C-St	F35	Width A	Width B	Weight	Art. no.	Price
Valance from Mesh	●	●	●	●	●	●	●	●	●	± 600	190-600	0,5 kg	437471	34,30



● Possible for the marked awning types. No adapter necessary.

● Mounting only possible with adapter!!!

The mounting of these side parts is only possible with the corresponding adapter.

Adapter kit for mounting on F65(S) / F65(L)      434991      11,90

Adapter kit Omnistor 5002/5003      434995      18,90



**Blocker Pro**

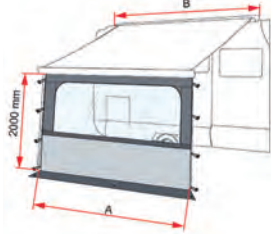

Front wall with large window and gray floor extension. Made of water-repellent, UV-resistant vinyl. Feeding into the keder rail. With pegs.



**Blocker Pro - Rainproof front part w/ panorama window**

Designation	F45S	F45L	F43	F40	F80s	F80L	F65	C-St	F35	Width A	Width B	Weight	Art. no.	Price
Blocker Pro 100*	●	●			●	●	●	●	●	± 100	100	0,8 kg	44381	125,-
Blocker Pro 250	●							●	●	± 235	250-260	2,7 kg	434915	192,-
Blocker Pro 260 VAN**			●	●					●	± 250	260-270	2,7 kg	4349151	214,-
Blocker Pro 280								●	●	± 255	270	3,0 kg	4349150	195,-
Blocker Pro 300	●		●		●		●	●	●	± 285	300-320	3,2 kg	4349152	217,-
Blocker Pro 325	●				●				●	± 310	325	3,4 kg	4349161	227,-
Blocker Pro 350	●				●		●	●	●	± 335	340-370	3,8 kg	4349153	227,-
Blocker Pro 375	●				●		●	●	●	± 360	375	4,1 kg	4349154	242,-
Blocker Pro 400	●				●		●	●	●	± 385	400-410	4,5 kg	4349155	246,-
Blocker Pro 425	●				●				●	± 410	425	4,7 kg	4349156	267,-
Blocker Pro 440								●	●	± 415	440	4,9 kg	4349157	267,-
Blocker Pro 450	●	●			●	●	●		●	± 435	450	5,0 kg	4349158	267,-
Blocker Pro 500		●						●	●	± 463	500	5,5 kg	4349159	299,-
Blocker Pro 550		●						●	●	± 513	550	6,0 kg	4349160	324,-



With blockers you quickly & inexpensively create a protection against wind & sun, no fixed connection at the edges of the front and side panels.

\* Without viewing window  
\*\* also suitable for original VW California awning.

**Side W Pro**

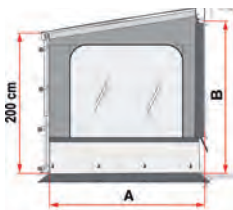

Practical side panel with large window and floor extension. Made of water-repellent, UV-resistant vinyl. Incl. telescopic rafter pole and pegs.



**Side W Pro / Side W Pro VAN - Weatherproof side panels with window**

Description	F45S	F45L	F43	F40	F80S	F80L	F65	C-St	F35	Depth A	Height B	Weight	Art. no.	Price
Side W Pro Van (for pull-out 225 cm)			●							210	180-210	4,5 kg	436350	244,-
Side W Pro VAN (for pull-out 250 cm)			●							230	180-210	4,9 kg	436351	253,-
Side W Pro F40				●						210	180-210	3,0 kg	443602	234,-
Side W Pro F45/F80s	●	●			●		●			230	225-280	4,2 kg	434972	248,-
Side W Pro XXL F45/F80s	●	●			●		●			230	280-330	4,5 kg	434973	293,-
Side W Pro F80L XL						●				275	245-280	4,8 kg	434969	288,-
Side W Pro F80L XXL						●				275	281-310	4,9 kg	434970	314,-
Side W Pro VAN F45s for VW T5/T6 *	●	●								190	180-200	3,4 kg	434974	248,-
Side W Pro F65/F80 for Fiat Ducato					●		●			230	225-280	4,2 kg	434975	248,-
Side W Pro Caravanstore								●	●	210	240-260	4,5 kg	434976	231,-
Side W Pro Caravanstore XL								●	●	240	240-260	4,8 kg	434977	274,-
Side W Pro F35 Van									●	210	180-220	4,2 kg	434978	240,-



**Side W Pro VAN**

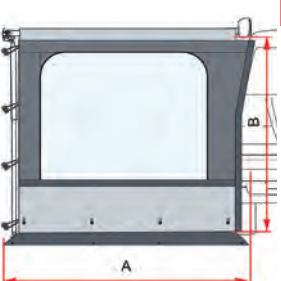

Like Side W Pro, but adapted to the contour of the vehicle side wall thanks to its special shape.

\* also suitable for Volkswagen California ≥ 2003.





Blocker

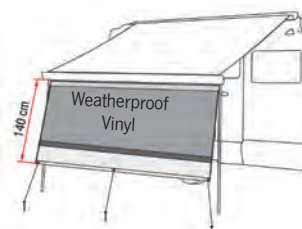

Practical blocker that is pulled into the piping front profile of the awning. Protects against rain and sun. Includes pegs and tension straps.

from 127,-

Side Block

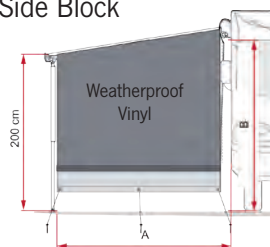

Vinyl side trim to match the blocker front panel. Washable, rot-proof and UV-resistant. Supplied as standard w/ aluminum tension rod, ground pegs & tension straps for fastening

Blocker - Rainproof vinyl front blocker

Description	F45S	F45L	F43	F40	F80s	F80L	F65	C-St	F35	Width A	Width B	Weight	Art. no.	Price
Blocker 260	●		●	●				●	●	± 253	260-300	2,3 kg	44382	127,-
Blocker 300	●		●		●		●	●	●	± 285	300-320	2,6 kg	434901	136,-
Blocker 325	●				●					± 310	325	2,7 kg	434904	150,-
Blocker 350	●				●		●	●		± 335	340-370	2,9 kg	434902	150,-
Blocker 400	●	●			●	●	●	●		± 385	400-410	3,3 kg	434903	152,-
Blocker 450	●	●			●	●	●	●		± 438	>450	4,0 kg	44383	173,-

Side block - side panel incl. aluminum tension rod

Designation	F45S	F45L	F43	F40	F80s	F80L	F65	C-St	F35	Depth A	Height B	Weight	Item no.	Price
Side block F45/F80	●	●			●					230	220-260	3,3 kg	440568	232,-
Side Block Caravanstore XL								●		240	180-260	3,3 kg	440569	227,-

SHADE with window blackout



Side W Pro Shade

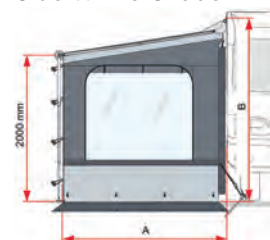

Rainproof Side panel with window & blackout

Side wall with large window and roll-up blackout. Otherwise like Side W PRO. Incl. telescopic aluminum tension rod and pegs.

Side block - side panel incl. aluminum tension rod

Description	F45S	F45L	F43	F40	F80s	F80L	F65	C-St	F35	Depth A	Height B	Weight	Art. no.	Price
Side W Pro Shade right	●	●			●	●	●			230	225-280	5,3 kg	434979	343,-
Side W Pro Shade left	●	●			●	●	●			230	225-280	5,3 kg	434980	343,-
Side W Pro Shade CS XL right								●		240	240-260	6,5 kg	436352	309,-
Side W Pro Shade CS XL left								●		240	240-260	6,5 kg	436353	309,-



● Possible for the marked awning types. No adapter necessary.

● Mounting only possible with adapter!!!

The mounting of these side parts is only possible with the corresponding adapter.

Adapter kit for mounting on F65(S) / F65(L)

434991

11,90

Adapter kit Omnistor 5002/5003

434995

18,90



**Sun View XL**

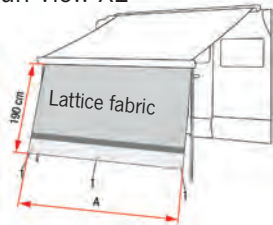

Mesh front wall. Reflects 85% of the light. Feeding into the keder rail. Can be rolled up with fastening clips. Incl. Pegs and tension straps. The mesh fabric is translucent and breathable.

**Sun View Side**



Side wall made of breathable translucent mesh. Reflects 85% of the light. Provides a pleasant indoor climate. Incl. Rafter tension rod, tension straps and pegs.

**Sun View Side VAN**

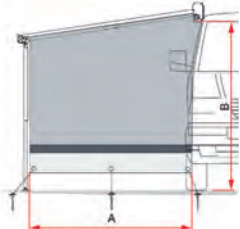

Like Sun View Side, but adapted to the contour of the vehicle side wall thanks to its special shape.

**Side W CaravanStore**

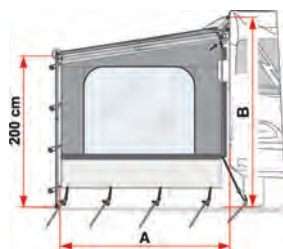

**Rainproof Side panel with window**

Side wall with window made of water-repellent, UV-resistant vinyl. Incl. telescopic aluminum rafter rod and rubber tensioners.



**Sun View XL - shade-providing Front part made of mesh fabric**

Designation	F45S	F45L	F43	F40	F80s	F80L	F65	C-St	F35	Width A	Width B	Weight	Item no.	Price
Sun View XL 100	●	●	●	●	●	●	●	●	●	± 100		0,5 kg	44384	107,-
Sun View XL 260	●		●	●				●	●	± 250	250-260	1,9 kg	44385	137,-
Sun View XL 300	●		●		●		●	●	●	± 285	300-320	2,1 kg	44386	144,-
Sun View XL 325	●				●					± 310	325	2,2 kg	434905	158,-
Sun View XL 350	●				●		●	●		± 335	340-370	2,3 kg	44387	159,-
Sun View XL 375	●				●		●	●		± 360	370	2,4 kg	44388	176,-
Sun View XL 400	●				●		●	●		± 385	400-410	2,5 kg	44389	176,-
Sun View XL 425	●	●			●	●	●	●		± 410	425	2,6 kg	44390	192,-
Sun View XL 450		●				●		●		± 435	450	2,7 kg	44391	192,-
Sun View XL 500		●				●		●		± 463	500-510	2,9 kg	44392	213,-
Sun View XL 550										± 513	550	3,1 kg	44393	227,-

**Sun View Side / Sun View Side VAN - Shadow-providing side panel made of mesh fabric**

Description	F45S	F45L	F43	F40	F80s	F80L	F65	C-St	F35	Depth A	Height B	Weight	Item no.	Price
Sun View Side VAN F45s	●									190	180-210	2,3 kg	436354	215,-
Sun View Side VAN (for 225 cm Pull-out)			●	●						210	180-210	2,4 kg	436355	215,-
Sun View Side VAN (for 250 cm Pull-out)			●							230	180-210	2,7 kg	436356	232,-
Sun View Side F45/F65/F80	●	●			●	●	●			230	220-260		44394	234,-
Sun View Side F80L						●				250	245-310		434906	256,-
Sun View Side Caravanstore								●	●	210	180-260		44395	220,-



**Side W CaravanStore - Rainproof side wall with window**

Description	F45s	F40L	F43	F40	F80s	F80L	F65	C-St	F35	Depth A	Height B	Weight	Art. no.	Price
Side W Caravanstore								●	●	210	240-260	3,9 kg	434981	190,-
Side W Caravanstore XL								●	●	250	240-260	4,2 kg	434982	244,-



## Fiamma Caravanstore Caravan awning for the keder rail



### The caravan awning in the case

- Lightweight and compact, arms and support feet lie in the awning tube
- Pullout possible to half length
- Waterproof case
- Mounting in the existing keder rail
- Awning cloth lightweight and waterproof, can be rolled up in both directions
- No wrinkling, even if awning is closed for a longer time
- For caravans, folding caravans & small motorhomes

Accessories:  
side parts  
Privacy Room CS Light

Blocker Front/  
Page 155-156  
see below

**Kit hobby**  
For mounting the  
Caravan gate  
to hobby living-  
trolley 2009.  
E3325 18,-



### Fiamma Caravanstore/Caravanstore XL - the light caravan awning for keder rail

	Housing Light gray										Housing black
Type	190	225	255	280 XL	310 XL	360 XL	410 XL <sup>1)</sup>	440 XL <sup>2)</sup>	500 XL <sup>3)</sup>	550 XL <sup>3)</sup>	310 XL
Total width	193 cm	235 cm	264 cm	286 cm	316 cm	36 cm	415 cm	448 cm	497 cm	547 cm	316 cm
Fabric width	162 cm	202 cm	232 cm	254 cm	284 cm	334 cm	384 cm	414 cm	465 cm	515 cm	284 cm
Pull-put	180 cm	225 cm	225 cm	250 cm	250 cm	250 cm	250 cm	250 cm	250 cm	250 cm	250 cm
Weight	6,0 kg	7,5 kg	8,5 kg	10,1 kg	11,2 kg	12,3 kg	13,5 kg	14,6 kg	15,8 kg	16,9 kg	11,2 kg
Royal Grey	44362	443621	443622	44423	444231	444232	444233	444234	444235	444236	44425
Royal Blue	44363	443631	443632	44424	444241	444242	444243	444244	444245	444246	—
Price	444,-	478,-	507,-	515,-	515,-	544,-	601,-	669,-	734,-	784,-	543,-

<sup>1)</sup> For 410 cm incl.: 1 tie rod Rafter <sup>2)</sup> For 440 cm incl.: 1 Rafter + additional. Front support <sup>3)</sup> At 500 cm + 550 cm incl.: 2 add. Front supports

## Fiamma Privacy Room CS Light Retrofit awning for caravan door

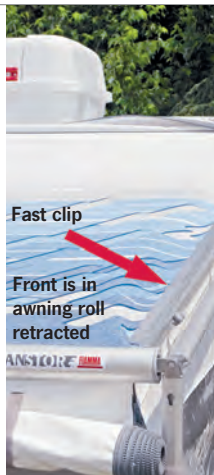

### More living space for caravan gate and Caravan Gate XL

- For Caravanstore from model 2004 w/ awning extension of 225 cm & Caravanstore XL w/ 250 cm extension
- With Fast Clip attachment system:
- Connection to caravan wall by elastic tension straps
- Front retractable into the keder rail
- Connection front/side parts by zippers
- Door retractable left or right
- Windows of the front with curtains
- Windows of the side parts with mosquito nets
- Incl. Pannier Mega Bag light

### Awning Tent Retrofit Set for Caravan Gate / Caravan Gate XL

Basic model	CS Light 280		CS Light 310		CS Light XL 280		CS Light XL 310	
	440488	988,-	440489	1010,-	440492	1022,-	440493	1029,-
Awning length	Front panels	+ Front extension sets to adjust the width						
360 cm	N: 50 cm		440499	52,10			440499	52,10
410 cm	Q: 100 cm		440501	103,-			440501	103,-
440 cm	S: 130 cm		440503	131,-			440503	131,-
500 cm	V: 190 cm						440504	161,-
550 cm	K + K + V 20(2x)+190cm						2 x 440497 + 440504	48,- 161,-

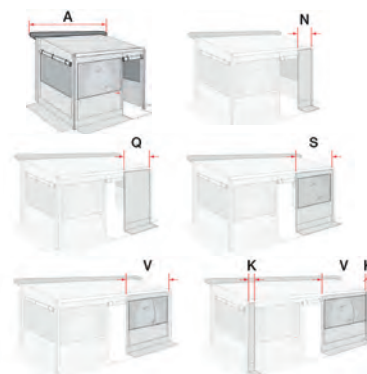

**Caravan awning in case with holder for awning**

- Awning canopy can be ordered as accessory
- Robust YKK zippers
- Rapid" linkage - facilitated assembly

**Scope of delivery awning:**

Awning, aluminum poles "Rapid Set" and packing bag. From type 360 with additional front support, from type 500 with 2 additional front supports.

**Optional awning awning**

**Privacy Caravanstore ZIP XL awning**

- Roll up front part and side parts
- Robust YKK zippers
- Incl. Transport bag

**Scope of delivery awning:**

Front with door and 2 side walls, each incl. window with mosquito net and curtains, "Rapid Set" aluminum poles, tensioning straps, hooks and packing bag.

**Accessories:**

Curtains, 1 pair, Dark Grey **440486 76,90**  
Curtains, 3 pairs, Dark Grey **440487 193,-**

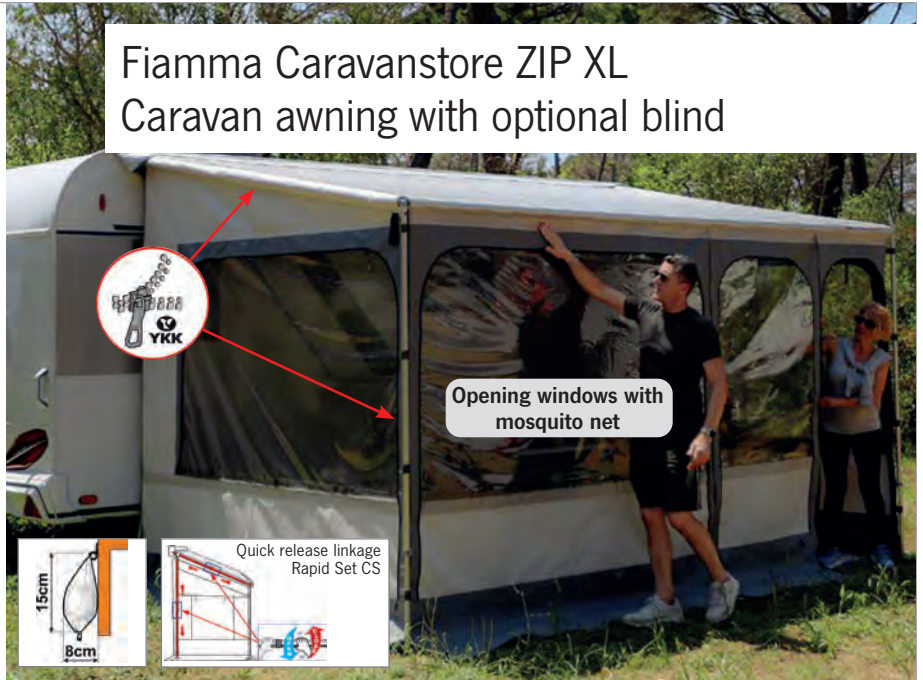

1. Select awning							+ 2. Order awning basic model in addition			+ 3. Front extension		
Awning model CaravanStore ZIP XL	(A) Total width	(B) Mounting height/ (C) Extension	Weight	Color Royal Grey	Color Royal Blue	Price	Matching awning basic model Privacy CS ZIP XL	Item no.	Price	Order extension front panels	Item no.	Price
ZIP XL 280	288 cm	240-260 / 250 cm	31,1 kg	443751	443752	660,-	XL 280	443766	1393,-			
ZIP XL 310	318 cm		32,5 kg	443753	443754	684,-	XL 310	443767	1466,-			
ZIP XL 360	369 cm		34,3 kg	443755	443756	798,-	XL 310	443767	1466,-	+ 1x 50 cm	435311	61,-
ZIP XL 410	419 cm		35,7 kg	443757	443758	823,-				+ 1x 100 cm	436623	121,-
ZIP XL 440	449 cm		37,2 kg	443759	443761	850,-				+ 1x 130 cm	436634	149,-
ZIP XL 500	509 cm		38,9 kg	443762	443763	1028,-				+ 1x 190 cm	436635	205,-
ZIP XL 550	559 cm		40,7 kg	443764	443765	1079,-				+ 2x 20 cm	436620	55,20
									+ 1x 190 cm	436635	205,-	

**How to order the CaravanStore ZIP XL with matching awning:** Choose the length of the awning to suit your needs. If required, order the matching basic awning model and complete the full width with the specified front panel extensions.

**Fiamma SlideOut**



SlideOut systems can be found in motorhome technology section

**Special SlideOut awning system for vehicles with extendable walls**

**The awning for mobile vehicle walls**

Ideal solution for vehicles w/ retractable side & rear walls. They protect the extension with an awning cloth that can be rolled out up to one meter and also automatically rewinds.

Special awning Slide Out	
Type	280
Awning width A	278 cm
Fabric width B	272 cm
Pull-out C	100 cm
Weight	10,0 kg
Housing Polar White	
Royal Grey	42528
Price	534,-



## TIE RODS AND ACCESSORIES

### Awning tensioning poles - Rafter / Rafter PRO

- Increases the rigidity of the awning, better fabric tensioning
- For awnings up to 250 cm extension (adjustable from 142-265 cm)
- Suitable for all housing awnings

Rafter straight

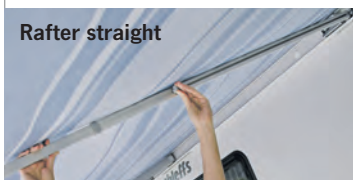

Rafter PRO curved



#### Rafter - straight tie rod

434554 54,90

#### Adapter F65

For older awnings F65 adapter is necessary to mount the rafter.

E4360 9,30

#### Rafter PRO - curved tension rod

Also improves water drainage. Attention: do not use in intense sunlight.

43315 77,40



### Magic Rafter PRO - crossbar with elevation

- Optimal transverse tensioning for awnings up to 450cm wide
- Better water drainage due to elevation of cloth
- A stiffener reduces wind noise
- Attention: Do not use in intense sunlight

43360 142,-

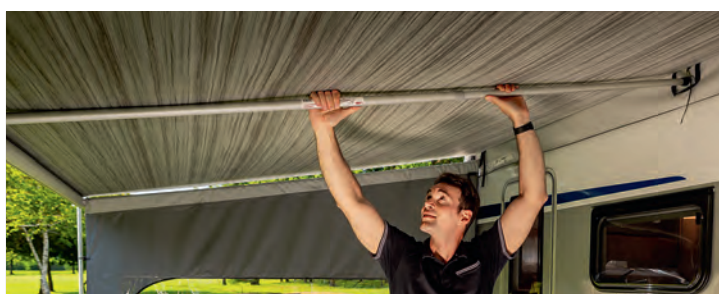

### Rafter aluminum tie rods with twist locks

Tension rod for caravan door w/ extension 225-250 cm  
434553 41,90



### Magic Rafter - Cross tension rod

- Universal rafter is clamped between the awning arms
- Better fabric tension, increased wind stability

43381 86,-

Further tension rods / rafters with lighting can be found on page 188

### Adapter set for Thule awnings



#### Kit Privacy O - Optional Kit

Optional kit that enables the installation of the Fiamma products Privacy Room and Privacy Room Light on the awnings Thule 4900-5002-5003-5200, Tristor 2.

Weight 0,2 kg  
E4263 45,70



### PLATE retaining plates

For fixing support leg to ground, safer in windy conditions. Plastic. With pegs for Fiamma and Omnistor. 20 x 20 cm.

2 piece 43547 17,50

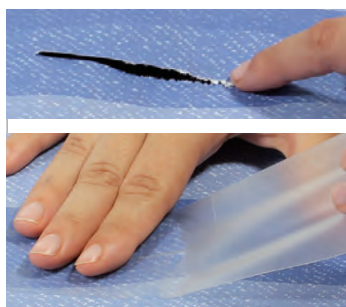

### Awnings repair kit

- Quick repair for tears in the awning cloth
- Self-adhesive
- Easy handling

43540 25,70



### Awning spoiler

Improves air resistance and appearance. Protection from damage. Material ABS. Is glued on with Sikaflex. For awning F45 and others.

43493 32,-

Fig. shows aluminum



### Wall mount

Support feet are securely hooked in. For mounting on the vehicle wall.

Aluminum 43549 40,90  
Plastic white E1887 30,50



### Privacy Rail Kit

Keder rail kit, with 4 rails of 100 cm each, which allows the attachment of an additional front part, should the awning not have a double keder rail in the front panel. Also suitable for attaching to the side panels

43596 35,50



**RainGuard awning waterproofing**

- Waterproofing against water penetration
- Between awning and vehicle wall
- Prevents the flow of rainwater

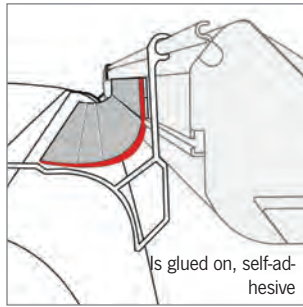

**RainGuard Van**  
For awnings F45S and F35 Pro, which are mounted at a small distance from minivans.  
Width 11 cm, color black  
300 cm **433881 108,-**



**RainGuard California**  
For awnings on Volkswagen T5/T6 California. Installation by plugging into the original Volkswagen rail.  
Length 200 cm.  
**433880 46,-**

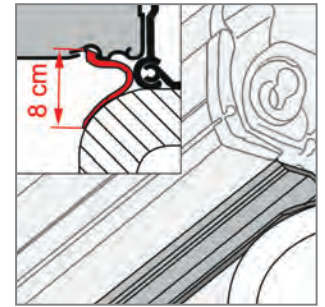

**RainGuard Lower**  
For F45S awnings with distance between cassette and vehicle with raised installation.  
per m **43388 12,99**  
550 cm **433882 82,50**

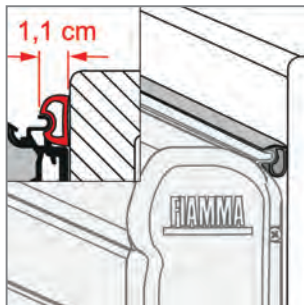

**RainGuard S**  
For awnings mounted on a flat wall with a standard bracket. Clamps behind the awning.  
550 cm **433841 57,-**

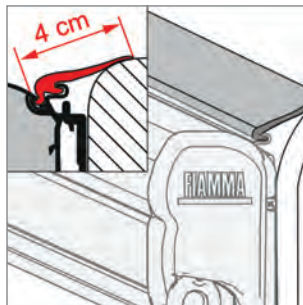

**RainGuard M**  
For awnings mounted with adapters protruding up to 4 cm or on curved walls.  
550 cm **433831 61,90**

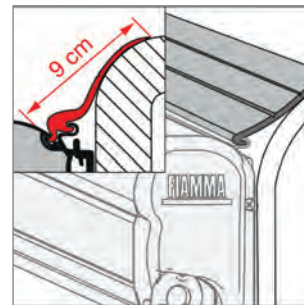

**RainGuard L**  
For awnings mounted with adapters protruding up to 9 cm or on strongly curved walls.  
550 cm **434852 70,-**

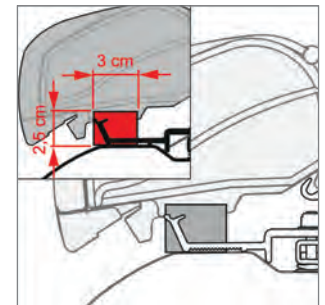

**RainGuard Kit F65/F80**  
For F 65 or F 80S, cover the gap between roof and adapter. 450 cm. Self-adhesive  
**434851 46,80**



**Rain end caps**

drain rainwater in a targeted manner. Ideal for use with awnings.  
2 rubber covers to be placed on the front panel. For F45 and Fiamma ZIP.  
Rain Caps F45S **43408 23,-**  
Rain Caps F45L **43409 23,30**

**Kit Cover + RainGuard Slim = sealing profile set for F80s**

For awning F80s with flat mounting adapter on Fiat Ducato panel van. Self-adhesive sealing profile kit Rain Guard Slim and side covers Kit Cover.



① Kit Rain Guard Slim **440515 43,99**  
② Kit cover **440513 37,-**



**Transport bags**

- Large and durable bag
- Ideal for transporting poles & tents

③ **Mega Bag Elite**  
Dims.: L150 x H35 x D35 cm  
**443971 169,-**

⑤ **Mega Bag**  
Dims.: L140 x H40 x D27 cm  
**440593 55,70**

④ **Mega Bag Smart L**  
Dims.: L195 x H25 x D25 cm  
**443973 87,-**

⑥ **Mega Bag Light**  
Dims.: L140 x H25 x D25 cm  
**440594 43,-**



**Set of 6 hooks**

for inserting into piping rail of front profile. Suitable for Fiamma & Thule Omnistor awnings. With 7 mm hole.  
**43443 9,-**





## Spare parts for Fiamma awnings

### End caps housing

for F40van		
black, right	E8349	48,80
black, left	E100101	48,80
for F45i, F1		
white, right	43826	23,95
white, left	438261	23,10
for F45 Plus, F50		
white, right	43827	23,90
for F45iL, F1L		
white, right	43828	22,95
white, left	438281	22,90
for F45 Plus L		
white, left	438291	27,80
for F45s		
white, right	E4434	54,-
white, left	E3914	54,-
silver, right	E6063	54,-
silver, left	E4968	54,-
black, right	E11465	54,-
black, left	E6667	54,-
for F45L		
white, right	E4702	40,80
white, left	E5914	38,70
silver, right	E4606	47,10
silver, left	E8855	47,10
for F65, Eagle		
white, right	43830	22,90
white, left	438301	22,90
silver, right	438302	26,10
silver, left	438303	26,10
for F65s version 15		
white, right	E4869	54,-
white, left	438304	54,-
silver, right	E3152	59,-
silver, left	E4374	54,-
black, right	E5272	54,-
black, left	E6471	54,-



End caps  
(symbol representation)



End caps  
Front profile  
(symbol representation)



### End caps housing

for F80s		
white, right	E9589	54,-
white, left	E9571	54,-
silver, right	E11892	54,-
silver, left	E11056	54,-
black, right	E10646	54,-
black, left	E10647	54,-
for F35pro		
silver, right	E5775	48,60
black, right	E5842	48,60
silver, left	E5721	48,60
black, right	E5841	48,60

### End caps front profile

for F40van		
black, right	E8496	33,10
black, left	E8458	33,10
for F45i, F1		
white, right	43831	12,10
white, left	438311	12,10
for F45iL, F1L		
white, right	43832	12,10
white, left	438321	12,10
silver, right	438322	19,70
silver, left	438323	18,80
for F45s		
white, right	E4435	17,20
white, left	E3938	17,30
silver, right	E6377	17,30
silver, left	E4933	17,30
black, right	E10592	17,20
black, left	E7192	17,30
for F45L		
white, right	E5693	17,20
white, left	E8095	17,30
silver, right	E839	17,10
silver, left	E6401	17,30
for F65, Eagle		
white, right	43833	16,30
white, left	438331	16,30
silver, right	438332	23,80
silver, left	438333	23,80
for F65s version 15		
white, left	E3807	15,50
silver, right	E4280	19,95
silver, left	E5983	19,90
black, right	E3197	19,90
black, left	SA1137	19,90
for F80s		
white, right	E5497	16,20
white, left	E9682	16,20
silver, right	E10422	16,20
silver, left	E11057	16,20
black, right	E72	16,20
black, left	E11588	16,20

### Awning foot joints top

for F45i, F1		
right	43822	18,60
left	438221	18,60
F45iL, F45TiL, F1L, F65		
right	43823	19,95
left	438231	19,95



Joint



Knurl

### Awning foot lock

for awning foot with knurled screw		
1 pc.	43824	7,95
for caravan door, F35		
2 pcs.	438242	28,95



Foot lock

### Locking piece for keder rail

for caravan door		
2 pcs.	43825	13,95



Locking piece

### Clips for Privacy Room

10 pcs.	43834	36,60
---------	-------	-------

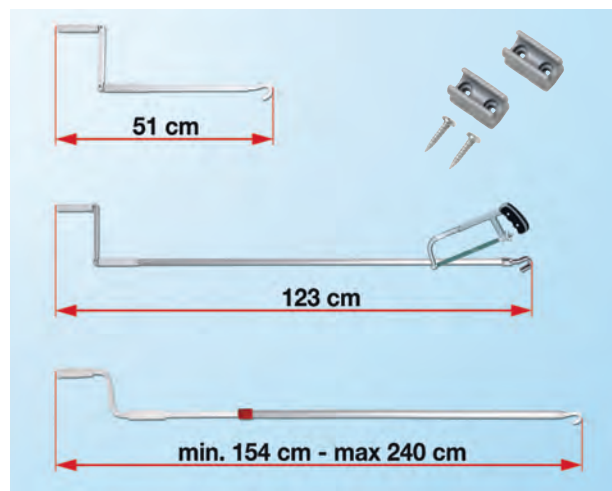

### Hand cranks, handle foldable

51 cm	43356	43,99
123 cm	43357	53,- 2 fas-
tening clips	43486	11,90

### Hand crank telescopic

154 - 240 cm	43358	65,-
2 mounting clips	E5405	14,40

All images in symbolic representation. Further spare parts can be found at [www.reimo.com](http://www.reimo.com) under the respective article.



With camping accessories from Thule you are flexible on the road and have plenty of space, comfort and safety. With renowned products of the Belgian company Omnistor, Thule has for years offered awnings and accessories for many vehicle sizes. Thule itself was founded in Sweden in 1942 and offers for its motorhome and Caravan accessories have a warranty of 2 years. In addition to wall, roof and keder rail awnings, Thule sells many other useful products for camping and caravanning.

## Different types of awnings



### Roof awning TO 6300

Widths: 260 - 500 cm  
 Pull-out: up to 250 cm  
 Cloth colors: Mystic Grey, Saphir Blue  
 Housing colors: White, silver, anthracite



### Roof awning TO 9200

Widths: 400 - 600 cm  
 Pull-out: up to 300 cm  
 Cloth colors: Mystic Grey, Saphir Blue  
 Housing colors: White, silver, cream



### Wall awning TO 5200

Widths: 190 - 500 cm  
 Pull-out: up to 250 cm  
 Cloth colors: Mystic Grey, Saphir Blue  
 Housing colors: White, silver, anthracite



### Wall awning TO 8000

Widths: 400 - 600 cm  
 Pull-out: up to 275 cm  
 Cloth colors: Mystic Grey, Saphir Blue  
 Housing colors: White, silver, cream, anthracite



### Wall awning TO 4200

Widths: 260 - 300 cm  
 Pull-out: up to 250 cm  
 Cloth colors: Mystic Grey  
 Housing colors: White, silver, anthracite



### Special awning TO 3200

Widths: 190 - 300 cm  
 Pull-out: up to 250 cm  
 Cloth colors: Uni grey  
 Housing colors: Silver, anthracite



### Special awning TO 5102

Widths: 260 cm  
 Pull-out: up to 200 cm  
 Cloth colors: Mystic Grey  
 Housing colors: Light Grey, anthracite



### Case awning TO 1200

Widths: 230 - 550 cm  
 Pull-out: up to 250 cm  
 Cloth colors: Mystic Grey, Saphir Blue  
 Housing colors: White

## Housing colors

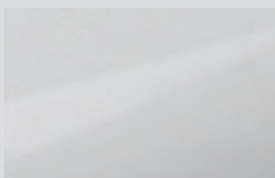

WHITE



SILVER ANODIZED

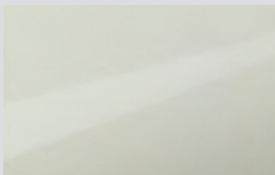

CREME

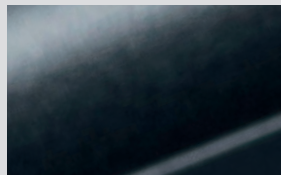

ANTHRACITE

## Fabric colors

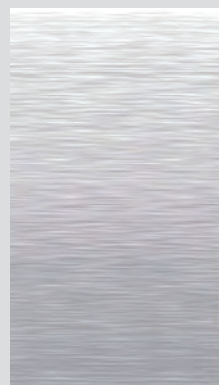

MYSTIC GREY

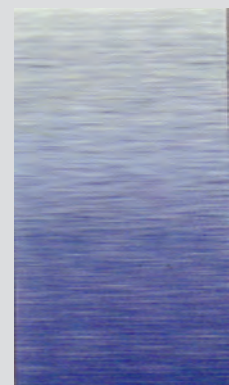

SAPHIR BLUE



## ROOF AWNING SET AND AWNING CANOPY FOR FIAT DUCATO

### Thule Omnistor 6300 Awning set for Fiat Ducato



Suitable for: Fiat Ducato ≥ 2007 panel van with vehicle height H2 (approx. 252 cm), Citroen Jumper ≥ 2007, Peugeot Boxer ≥ 2007, Opel Movano ≥ 2021 |

• Incl. Adapter set and sealing foam tape between awning and vehicle and adapter cover caps

- For vehicles with
  - length 541 cm = awning 325 cm
  - length 599 cm = awning 375 cm
  - length 636 cm = awning 400 cm

Awning set with 6300 incl. adapter			
Wide	325 cm	375 cm	400 cm
Pull-out	250 cm	250 cm	250 cm
Weight	24,0 kg	27,5 kg	29,0 kg

Housing White - Caps White			
Mystic Grey	428000	428001	428002
Price	1324,-	1374,-	1414,-

Silver housing - Black caps			
Mystic Grey	428065	428066	428067
Price	1349,-	1399,-	1439,-

Silver housing - Grey caps			
Mystic Grey	428072	428073	428074
Price	1349,-	1399,-	1439,-

Black housing - Black caps			
Mystic Grey	428075	428076	428077
Price	1349,-	1399,-	1439,-

### Awning Panorama



Photo shows awning tent w/ optional mosquito net.



- Side parts adapted to vehicle contour
- All pages completely removable with zipper
- OPTION: Removable mosquito screens
- Incl. Bottom apron and 2 panniers

Suitable for: FIAT Ducato panel van - Citroen Jumper ≥ 2007, Peugeot Boxer ≥ 2007, Opel Movano ≥ 2021.

**Scope of delivery:** Tent, pack bag, pegs and windbreak to prevent drafts from moving under the vehicle.

**Further information & accessories:** s. pg. 180.

#### Thule Panorama - awning tent for Ducato H2

Tent width	Mounting height	Item no.	Price
325 cm	Ducato (230 - 250 cm)	431791	2800,-
375 cm	Ducato (230 - 250 cm)	431792	2880,-
400 cm	Ducato (230 - 250 cm)	431793	2880,-

### QuickFit awning canopy



Information & accessories: See page 178.

- Side parts adapted to vehicle contour
- Small pack size
- Including floor skirt and curtains
- Front window can be opened completely
- 18 kg light
- Suitable for all Fiat Ducato awning widths (325 cm - 350 cm - 375 cm - 400 cm)
- Also suitable for Ducato models before 2007

Suitable for: FIAT Ducato panel van, Citroen Jumper ≥ 2007, Peugeot Boxer ≥ 2007, Opel Movano ≥ 2021

**Scope of delivery:**

Tent, pannier (dims. app. 70 x 35 x 35 cm), pegs, curtains and wind screen to prevent draughts from passing under the vehicle.

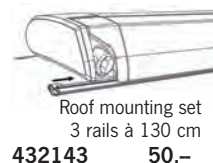

Roof mounting set  
3 rails à 130 cm  
432143 50,-



Incl. Pannier

#### Thule QuickFit - awning tent for Ducato H2

Tent width	Mounting height	Item no.	Price
300 cm	Ducato (230 - 250 cm)	432145	949,-



# Thule Omnistor 6300 Awning for vans and caravans

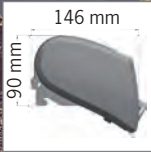

**Maximum  
Extension 250 cm**

## Shade and weather protection for vans, motorhomes & caravans

- Widths up to 500 cm, adjustable dropout angle
- From 375 cm with additional tensioning arms for perfectly tensioned awning cloth
- 3. Support foot optionally available from 375 cm width to increase stability
- Integrated rain gutter in the front strip



**TÜV Rheinland,**  
one of most qualified providers of product testing & certification, has also certified many Thule products.



**Additional clamping arms**  
Robust articulated arms with integrated, patented Tensioning arms ensure a perfectly tensioned awning fabric.

Thule Omnistor 6300 - Housing color white									
Wide	260 cm	300 cm	325 cm	350 cm	375 cm	400 cm	425 cm	450 cm	500 cm
Pull-out	200 cm	250 cm	250 cm	250 cm	250 cm	250 cm	250 cm	250 cm	250 cm
Weight	20,6 kg	24,1 kg	25,1 kg	26,8 kg	28,5 kg	30,5 kg	31,8 kg	33 kg	35,6 kg
Mystic Grey	42830	428301	428302	428303	428304	428305	428306	428307	428308
Saphir Blue	42831	428311	428312	428313	428314	428315	428316	428317	428318
Price	929,-	1009,-	1149,-	1149,-	1209,-	1239,-	1319,-	1319,-	1419,-

Thule Omnistor 6300 - Housing color silver anodized					
Wide	325 cm	350 cm	375 cm	400 cm	450 cm
Pull-out	250 cm	250 cm	250 cm	250 cm	250 cm
Weight	25,1 kg	26,8 kg	28,5 kg	30,5 kg	31,4 kg
Mystic Grey	42832	428320	428321	428322	428323
Saphir Blue	42833	428330	428331	428332	428333
Price	1174,-	1174,-	1234,-	1264,-	1344,-

Thule Omnistor 6300 - Housing color black							
Wide	260 cm	300 cm	325 cm	350 cm	375 cm	400 cm	425 cm
Pull-out	200 cm	250 cm	250 cm	250 cm	250 cm	250 cm	250 cm
Weight	20,6 kg	24,1 kg	25,1 kg	26,8 kg	28,5 kg	30,5 kg	31,8 kg
Mystic Grey	42834	428340	428341	428342	428343	428344	428330
Price	954,-	1034,-	1174,-	1174,-	1234,-	1264,-	1344,-

### Motor kit for Thule Omnistor 6300

for retrofitting a 230 V tubular motor to existing awning.

White	430754	540,-	Silver
anodized	430755	540,-	
Black	430756	540,-	

**Scope of delivery for Thule Omnistor 6300** Telescopic crank, support foot attachment to the wall and pegs.

### Accessories for Thule Omnistor 6300

Vehicle-specific adapter sets, absolutely necessary for mounting	Page 167
Thule awning tents QuickFit, Panorama or Residence G3	Page 178-180
Thule Windscreen, Sun- and Rainblocker	Page 176-177
Tension rods and accessories	Page 181

**3. Support foot** (possible from 375 cm width)  
**E5049 84,-**

### Tent and LED mounting rail

Mounting rails for mounting under the awning. For attaching awning QuickFit and simultaneous installation of LED lighting. 3 rails of 130 cm. Anthracite **43889 64,-**

### LED Strip, side emitting

Special LED tape for above LED mounting rail. Side-emitting, self-adhesive. 12 V. Length 400 cm **43890 130,-**



# Thule Omnistor 9200 for large motorhomes and caravans



### Extra large shade for extra large vehicles

- Largest extension w/ 300 cm - width up to 6 m
- Optimally suitable for many vehicle types with various adapter sets
- With integrated additional tensioning arms for high fabric tensioning

### Scope of delivery Thule Omnistor 9200

Telescopic crank, support foot attachment to the wall, pegs and tension rod.

### The Thule Omnistor 9200 with 230 V EM motor kit

- 230 VAC EM (= electrical-mechanical limit switch) Motor
- Remote control & control box incl.
- The control box ensures that the awning cannot be opened while driving
- Easy connection to a 230 VAC mains (if you have a 12V connection, you can use a 300 watt inverter)

Control box dims.: 160 x 92 x 51 mm, motor cable length: 5 m, power supply: 4 x 0.75 mm<sup>2</sup>: EMC approved, motor w/ thermal protection.

### Mounting

It is essential to order one of the adapters listed on page 167.

### Accessories for Thule Omnistor 9200

Thule Panorama Awning	Page 180
Thule Residence G3 awning tent	Page 179
Thule Windscreen, Sun- and Rainblocker	Page 176 - 177

### Motor kit for Thule Omnistor 9200

for retrofitting a 230 V EM motor to existing awning.

Easy programming, with control box and remote control. Description see above

White	426722	714,-
Silver anodized	426723	714,-
Cream	426724	714,-



### Suitable inverter 12 V to 230 V

for connecting the awning motor to 12 volt on-board system.

Continuous power 500 W **82293** **64,90**

### Thule Omnistor 9200

Wide	400 cm	450 cm	500 cm	550 cm	600 cm
Pull-out	300 cm	300 cm	300 cm	300 cm	300 cm
Weight	41,0 kg	44,5 kg	48,0 kg	51,5 kg	55,0 kg

### Housing color white

Mystic Grey	428200	428210	428220	428230	428240
Saphir Blue	428202	428212	428222	428232	428242
Price	1589,-	1809,-	2019,-	2219,-	2389,-

### Housing color white with 230 V EM motor\*

Mystic Grey	426748	426745	426749	426752	426755
Price	2159,-	2379,-	2589,-	2789,-	2959,-

### Housing color silver anodized

Mystic Grey	428204	428214	428223	428234	42825
Saphir Blue	428205	—	428225	428235	428250
Price	1629,-	1849,-	2059,-	2259,-	2429,-

### Housing color silver anodized w/ 230 V EM motor\*

Mystic Grey	426743	426746	426750	426753	426756
Price	2199,-	2419,-	2629,-	2829,-	2999,-

### Housing color cream

Mystic Grey	42826	428260	428261	428262	—
Price	1589,-	1809,-	2019,-	2219,-	

### Housing color cream with 230 V EM motor\*

Mystic Grey	426744	426747	426751	426754	426757
Price	2159,-	2379,-	2589,-	2789,-	2959,-

\*The weight increases by approx. 3 kg

### Mounting system for flat roofs

Adapters are mounted on tilting and sliding cross rails. Awning closes with roof edge or keder rail. Is screwed to the edge strip. For awning widths up to 350 cm you need 1 x Set 2, for widths from 375 cm to 400 cm you need 1 x Set 3 & for widths from 450 cm you need you need 2 x set 2.

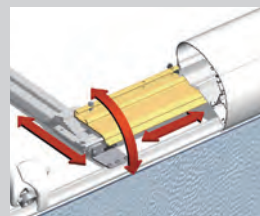

Set 2 with 2 mounting rails	43010	205,-
Set 3 with 3 mounting rails	43011	285,-

**Roof mounting adapter for panel vans and buses**

TO 6300

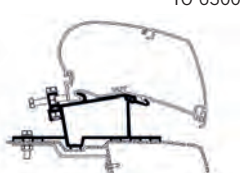

**Renault/Opel**  
Renault Master,  
Opel Movano  
< 2010  
2 Holder **43023 168,-**

TO 6300



**Mercedes-Benz Sprinter**  
>2006, Volkswagen  
**Crafter 2006-2017**  
Only for series high roof  
3 Holder **43041 159,-**

TO 6300



**Volkswagen Crafter**  
> 2017  
Only for standard high roof H3,  
Vehicle height 259 cm.  
3 Holder **43048 351,-**  
UK version **43055 351,-**

TO 6300

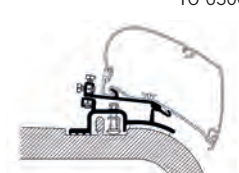

**Fiat / Peugeot / Citroën**  
**Fiat Ducato, Peugeot Boxer, Citroën Jumper**  
1994-2006  
2 Holder **43022 159,-**

For H2 TO 6300



**Fiat Ducato, Peugeot Boxer, Citroën Jumper**  
≥ 2007,  
**Opel Movano** ≥ 2021  
Set for awning width 325 cm  
3-piece. **430092 199,-**  
Set for width 375 and 400 cm  
4-piece. **430093 214,-**

**Thule Roof Rack for Fiat Ducato ≥ 2007 with height H2**  
**Crossbars with adapter for awning mounting TO 6300**

- Set of 2 base rails with SmartClamps ❶ and Awning mountings ❷. (additional awning adapter required).
- The roof must be 10 cm from attachment points be free of obstacles to the inside.
- Mounting the SmartClamps ❶ at the original attachment points.
- The base rails ❷ are glued and connected to the SmartClamps.

Vehicle length	Awning	System	Art. no.	Price
541 cm	325 cm	6 point	<b>41103</b>	<b>429,-</b>
599 cm	375 cm	8 point	<b>41104</b>	<b>469,-</b>
636 cm	400 cm	8 point	<b>41105</b>	<b>479,-</b>

**Accessories:**

- 2 x crossbars 150 cm wide and base height 10 cm. **41106 409,-**
- 2 x crossbars 150 cm wide and foot height 13 cm. **41107 409,-**



TO 6200



**Renault Master G2**  
Renault Master ≥ 2010 and Opel Movano 2010 - 2021.  
Master L2 = awning 325 cm  
Master L3 = awning 375 cm  
Master L4 = awning 400 cm  
3 holders à 17,5 cm.  
**426780 199,-**



**Sealing tape** self-adhesive,  
25 x 30 mm, 2 x 200 cm.  
For sealing between the awning and the roof.  
**43292 55,-**

**Roof mounting adapter for motorhomes and caravans**

TO 9200  
TO 6200  
TO 6300

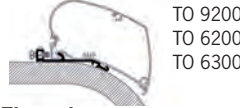

**Flat adapter**  
Also prevents the passage of rainwater.  
300 cm **43027 222,-**  
350 cm **43028 248,-**  
400 cm **43029 285,-**

TO 9200  
TO 6200  
TO 6300



**Roof Top Adapter**  
For motorhomes & caravans with flat roofs, 2 x 27 cm + 2 x 50 cm.  
4 Holder **430410 173,-**

TO 9200  
TO 6200  
TO 6300

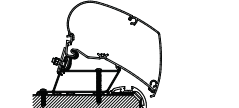

**Carthago Malibu**  
Malibu adapter 4.50 m. Also suitable for Fendt Caravan model ≥ 2020.  
450 cm **430201 350,-**

TO 9200  
TO 6200  
TO 6300



**Adria Roof Adapter**  
For caravan from model 2015, awning widths of 2-6 m.  
**43134 214,-**

TO 9200  
TO 6300



**Rapido Compact**  
350 cm **430608 340,-**  
400 cm **430609 377,-**  
450 cm **430610 441,-**

TO 9200  
TO 6200  
TO 6300



**Hobby Caravan 2009**  
2 x 27 cm + 2 x 50 cm  
**E7013 214,-**

TO 9200  
TO 6200  
TO 6300



**Hobby Premium and Ontour**  
2 x 27 cm + 2 x 50 cm  
**E4542 214,-**

TO 9200  
TO 6200  
TO 6300

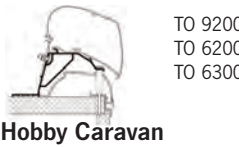

**Hobby Caravan**  
for models ≥ 2013.  
Set of 4 adapters.  
**426790 214,-**

TO 9200  
TO 6200  
TO 6300

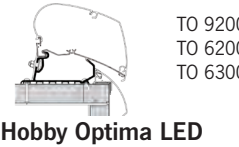

**Hobby Optima LED**  
Deluxe / Premium  
2 x 50 cm + 2 x 27 cm  
**431103 214,-**

TO 9200  
TO 6200  
TO 6300

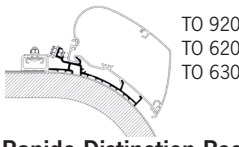

**Rapido Distinction Roof Adapter**  
450 cm **43046 350,-**

TO 9200  
TO 6300



**Laika Kreos**  
for awning width 375-500 cm.  
3 Holder **426782 214,-**

TO 9200  
TO 6300



**Laika Ecovip**  
for awning width 375-500 cm.  
3 Holder **426781 214,-**

**NEW**

**Mobilvetta**  
for awning width 350 - 400 cm  
Set of 4 adapters.  
**426980 214,-**

TO 9200  
TO 6300



TO 9200  
TO 6200  
TO 6300

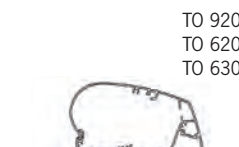

TO 9200  
TO 6200  
TO 6300



**Rapido Compact Integral**  
Adapter rail in Length 500 cm  
**426792 350,-**

TO 9200  
TO 6200  
TO 6300



**Hymer**  
Hymer 2013 caravans & motorhomes, Eriba Nova  
350 cm **43114 248,-**  
400 cm **431140 285,-**  
450 cm **431141 350,-**  
500 cm **431142 350,-**  
550 cm **431143 419,-**  
600 cm **431144 419,-**

TO 9200  
TO 6200  
TO 6300



**Carthago Chic** ≥ 2014 +  
**Malibu** ≥ 2021  
400 cm **430211 285,-**  
450 cm **430212 350,-**  
500 cm **430213 350,-**  
Until YOC. 2014  
400 cm **E3741 285,-**  
450 cm **43021 350,-**  
500 cm **E3543 350,-**  
550 cm **43109 419,-**

TO 9200  
TO 6300

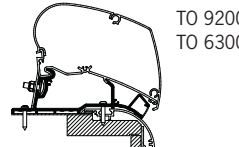

**Caravan Roof LED**  
Integrated LED channel for an optional LED. Suitable for various vehicles: eg Kabe, LeVoyageur Héritage  
425 cm **426761 364,-**  
450 cm **426762 364,-**  
500 cm **426763 364,-**  
550 cm **426764 432,-**  
600 cm **426765 432,-**

**Caravan Roof**  
E.g. Dethleffs caravans 2014, Fendt caravans (except Brilliant), also LMC & Trigano caravans  
3x100 cm **43203 248,-**  
300 cm **43137 248,-**  
350 cm **43145 248,-**  
400 cm **431145 285,-**  
450 cm **431146 350,-**  
500 cm **431147 350,-**  
550 cm **431148 419,-**  
600 cm **43146 419,-**



# Thule Omnistor 5200 for motorhomes and vans



### Thule Omnistor 5200

Width cm	190	230	260	300	315	350	375	400	450	500
Pull-out cm	140	180	200	250	250	250	250	250	250	250
Weight kg	14,2	17,0	19,0	22,6	23,4	25,4	26,7	28,0	30,4	32,8

### Housing color white

Mystic Grey	42600	42601	42602	42603	-	42604	-	42605	42606	42666
Saphir Blue	42607	42608	42609	42610	-	42611	-	42612	42613	42667
Price	799,-	829,-	869,-	949,-		1039,-		1119,-	1239,-	1369,-

### Housing color silver anodized

Mystic Grey	42628	42629	42630	42631	-	42632	-	42633	42634	42668
Saphir Blue	-	-	-	-	-	42637	-	-	42639	426000
Price	824,-	854,-	894,-	974,-		1064,-		1144,-	1264,-	1394,-

### Housing color anthracite

Mystic Grey	-	-	42650	42651	42669	42652	42678	42653	426530	426001
Price			894,-	974,-	1064,-	1064,-	1104,-	1144,-	1264,-	1394,-

### Thule Omnistor 5200 w/ 12 V motor\* - housing color white

Mystic Grey	-	-	-	42595	-	42599	-	42596	42597	426002
Price				1319,-		1409,-		1489,-	1609,-	1739,-

\*The total weight of the awning with the motor increases by approx. 1 kg



### Thule Subsola

The triangular sails for the T05200 in width 260 cm can be found on page 175.



## Only with Thule Omnistor 5200



### Thule Pitch System

The adjustable drop angle on Thule Omnistor 5200's hinged arms allows awning to be extended & retracted even when door is open.

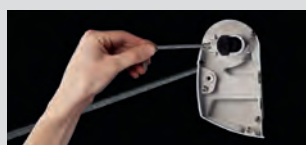

### Optimal closure

Another new feature is a simple cloth roller adjustment for perfect closing on the opposite side of the gearbox.



	White	Silver	Anthracite	
300 cm	43149	431490	431491	124,-
350 cm	431492	431493	431494	124,-
400 cm	431495	431496	431497	134,-
450 cm	431498	431499	-	139,-

## Fast shade for caravans, compact motorhomes and vans

- Extension up to 2.50 m, width up to 5.00 m
- Housing with integrated rain gutter
- Robust and stable articulated arms with failure setting
- Thule Pitch System - Freely adjustable dropout angle
- Optimum fabric tension due to additional clamping arms (from 400 cm series, for 300 cm & 350 cm retrofittable w/ part no. 432960)
- Third support foot can be mounted optionally
- Cloth roll adjustment for perfect closure

### Accessories for Omnistor 5200

Adapter sets for special mounting situations	P. 172-173
Thule awning tents	P. 178-180
Thule Windscreen, Sun- and Rainblocker	P. 176-177
Thule tension rods	S. 181

### Additional Clamping arm set

for 300 cm and 350 cm **432960 45,-**

### Additional support foot,

recommended from 350 cm **E5049 84,-**

### Scope of delivery of Thule Omnistor 5200

3 or 4 adapters, depending on width of the awning, for attachment to a vertical vehicle wall, telescopic crank, support foot attachment to d. Wall, pegs & tension rod.

**12 Volt motor kit for Thule Omnistor 5200** for retrofitting to the existing awning. Width + 3 cm, weight + 600 g.

White	<b>430751 540,-</b>
Silver anodized	<b>430752 540,-</b>
Anthracite	<b>430753 540,-</b>

### Tent & LED mounting rail for Thule Omnistor 5200

for mounting under the awning. With keder rail for attaching tent EasyLink or QuickFit & mounting place for LED light strips.

# Thule Omnistor 8000 for large motorhomes and caravans



## Noble wall awning with large extension for large motorhomes and caravans

- Largest extension of up to 275 cm - width up to 600 cm
- Housing in white, anodized or cream
- With integrated additional tensioning arms for high fabric tensioning
- Optional motor kit w/ remote control is available

### Scope of delivery of Thule Omnistor 8000

3 or 4 adapters, depending on the length of the awning, for attachment to a vertical vehicle wall, telescopic crank, support foot attachment to the wall, pegs and tension rod.

### Thule Omnistor 8000 w/ 230 V EM motor kit

- 230 VAC EM (= electrical-mechanical limit switch) Motor
- Remote control & control box incl.
- The control box ensures that awning cannot be opened while driving
- Easy connection to a 230 VAC mains  
(for a 12V connection you can use a 300 Watt inverter)

Control box dims.: 160 x 92 x 51 mm, motor cable length: 5 m, power supply: 4 x 0.75 mm<sup>2</sup>. EMC approved, motor w/ thermal protection.

### Accessories for Thule Omnistor 8000

Adapter sets for special mounting situations	S. 172-173
Thule QuickFit awning tent	S. 178
Thule Panorama Awning	S. 180
Thule Residence G3 awning tent	S. 179
Thule Windscreen, Sun- and Rainblocker	S. 176-177

### Motor kit for Thule Omnistor 8000

Description see above		
<b>Motor Kit 230 Volt EM White</b>	<b>426718</b>	<b>714,-</b>
<b>Motor kit 230 Volt EM Silver anodized</b>	<b>426719</b>	<b>714,-</b>
<b>Motor Kit 230 Volt EM Cream</b>	<b>426720</b>	<b>714,-</b>
<b>Motor kit 230 Volt EM Anthracite</b>	<b>426721</b>	<b>714,-</b>

### Suitable inverter 12 V to 230 V

for connecting the awning motor to 12 volt on-board system.  
Continuous power 500 W      **82293**      **64,90**

Thule Omnistor 8000					
Wide	400 cm	450 cm	500 cm	550 cm	600 cm
Pull-out	275 cm	275 cm	275 cm	275 cm	275 cm
Weight	41,4 kg	44,6 kg	48,2 kg	51,8 kg	55,4 kg

Housing color white					
Mystic Grey	4323610	4323640	432370	4323600	4323602
Saphir Blue	4323620	4323650	4323670	4323350	-
Price	1429,-	1599,-	1879,-	2029,-	2179,-

Housing color white with 230 V motor*					
Mystic Grey	426725	426728	426731	426735	426739
Price	1999,-	2169,-	2449,-	2599,-	2749,-

Housing color silver anodized					
Mystic Grey	4323810	432383	432389	4323800	4323802
Price	1469,-	1639,-	1919,-	2069,-	2219,-

Housing color silver anodized w/ 230 V motor*					
Mystic Grey	426726	426729	426732	426736	426740
Price	2039,-	2209,-	2489,-	2639,-	2789,-

Housing color cream					
Mystic Grey	432355	432356	432357	432358	432359
Price	1429,-	1599,-	1879,-	2029,-	2179,-

Housing color Cream w/ 230 V motor w/ 230 V motor*					
Mystic Grey	426727	426730	426733	426737	426741
Price	1999,-	2169,-	2449,-	2599,-	2749,-

Housing color anthracite with 230 V motor*					
Mystic Grey	-	-	426734	426738	426742
Price			2489,-	2639,-	2789,-

\*The total weight of awning with motor increases by app. 2 kg



Motor kit for Thule Omnistor 8000



# Thule Omnistor 4200

## Lightweight awning for compact vans



**Patented cloth roll support:**

The cloth roll support improves the fabric tension and reduces the risk of wrinkling in the cloth.

**Improved support:** The support feet are held in position so that they do not fall out of the front panel when the awning is opened.

**Intelligent innovation:**

The support feet swivel vertically out of the front bar: no risk of damage to the vehicle wall.

**Perfect fixation:** Strong clamping force of the support feet to cope with the high loads of mark- tents and guy ropes.

**Adapter selection**

Mounting example of a Multirail-Adapter on the REIMO Multirail



Thule Omnistor 4200		
Width cm	260	300
Pull-out cm	200	250
Weight kg	17,5	19,7

Housing color white		
Mystic Grey	426771	426773
Price	742,-	810,-

Housing color silver anodized		
Mystic Grey	426772	426774
Price	742,-	810,-

Housing color anthracite		
Mystic Grey	426700	426701
Price	779,-	849,-

### TO 4200

- Suitable for a wide range of compact vans
- Special removable adapters for the REIMO Multirail
- Perfect fixation of the support feet
- Stowage of the support feet in the front panel
- Lightest in its category: 17.5 kg for 2.60 m length

**Scope of delivery:**

Awning TO 4200 in width 260 cm or 300 cm with crank. Suitable, vehicle-specific adapters must be ordered separately. Case: White, Silver or Anthracite, Cloth: Mystic Gray.

**Accessories for Omnistor 4200:**

Vehicle specific adapters	Page 172-174
REIMO Multirail	Page 103
Thule Residence G3 awning tent	Page 179
Thule Sun and Rain Blocker	Page 176-177
Thule Windscreen	Page 177
Thule Subsola triangular sail	Page 175

- Thule Rainblocker complete set**  
to extend the awning (width 260 cm) to the awning.  
**Scope of delivery:** 2x Rainblocker Front XS, W 130 cm, H 185 cm, 2x Rainblocker Side XS, transport bag  
Weight approx. 11 kg  

<b>43089</b>	<b>764,-</b>
<b>Thule Residence G3 B 260 cm</b>	<b>42925 1835,-</b>
  - Rain Blocker G2 Front - front wall with window**

<b>Wide</b>	<b>Height</b>	<b>Item no.</b>	<b>Price</b>
130 cm	185 cm	<b>430841</b>	<b>159,-</b>
  - Rain Blocker G2 Side - Side panel with window**

<b>Pull-out</b>	<b>Type</b>	<b>Height</b>	<b>Item no.</b>	<b>Price</b>
200 cm	XS	180 -199 cm	<b>430883</b>	<b>257,-</b>
  - Sun Blocker G2 Front - front wall mesh fabric**

<b>Wide</b>	<b>Height</b>	<b>Item no.</b>	<b>Price</b>
100 cm	170 cm	<b>430873</b>	<b>129,-</b>
240 cm	170 cm	<b>430874</b>	<b>154,-</b>
- not shown. **View Blocker Front - front wall without window**
- |             |               |                 |              |
|-------------|---------------|-----------------|--------------|
| <b>Wide</b> | <b>Height</b> | <b>Item no.</b> | <b>Price</b> |
| 240 cm      | 140 cm        | <b>430822</b>   | <b>144,-</b> |

- Thule Subsola**  
Triangular sails for TO4200, TO4900, TO5102 and TO5200 can be found on page 175.





Thule Omnistor 3200  
for Vans and camper vans



**TO 3200**

- Very large extension of 250 cm
- Small cassette with light weight
- Manually unrollable - one-man operation
- Cloth tensioning system w/ ratchet technology
- Soft, water-repellent cloth made of polypropylene.
- Quick Lock system for variable height adjustment of support feet

**Scope of delivery:**

Awning for manual operation. A vehicle-specific adapter is required for mounting (please also order).

**THULE 3200**

Wide	190 cm	230 cm	250 cm	270 cm	300 cm
Pull-out	250 cm	250 cm	250 cm	250 cm	250 cm
Weight	12,0 kg	13,8 kg	14,7 kg	15,6 kg	16,9 kg

**Housing silver anodized**

Uni Grey	—	—	426800	426801	426802
Price			649,-	669,-	689,-

**Housing Black**

Uni Grey	426803	426804	426805	426806	426807
Price	629,-	649,-	669,-	689,-	709,-

**Accessories for THULE 3200:** Vehicle-specific adapter  
Thule Sun and Rain Blocker

Page 172-174  
Page 176-177

**For Volkswagen Transporter 5/6 or Multivan**

- With 90 cm long crank adapted to the height of the vehicle - quick to extend
- For flat roof with C-rail on the roof
- Rail can also be retrofitted (available from Volkswagen dealers)

Suitable for: Volkswagen Multivan Transporter ≥ 2003\*

**Thule Omnistor 5102**

Wide	260 cm
Pull-out	200 cm
Weight	19,8 kg
Housing anthracite	426714 879,-
Housing light Grey	426715 879,-

**Accessories for Omnistor 5102:**

Thule Residence G3 awning tent for Volkswagen Transporter/Multivan 5/6	
Color grey	433012 1835,-
Thule awning Residence	Page 179
Thule Sun and Rain Blocker	Page 176-177
Thule Windscreen	Page 177
Thule Subsola triangular sail	Page 175

**Scope of delivery:** Awning w/o. adapter.

\* Not suitable for vehicles with high or pop-up roof.

Thule Omnistor 5102 special awning  
for Volkswagen Transporter 5/6/6.1











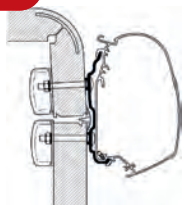
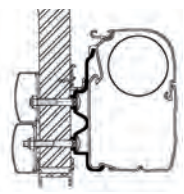

If Volkswagen Original rail not available, please obtain from Volkswagen.

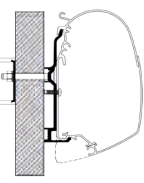
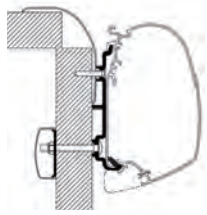
**Adapter**

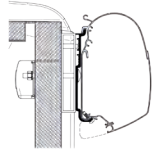
Volkswagen T5/T6/T6.1 LHD	426716	138,-
Volkswagen T5/T6/T6.1 RHD	426717	138,-
Hymer Car 302 - Ducato H1	E3758	121,-

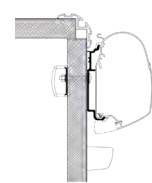
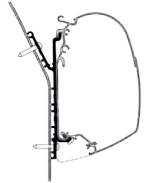
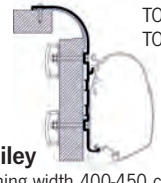
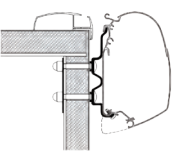

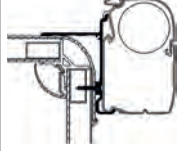
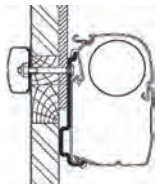
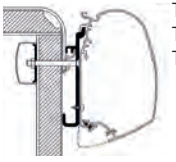
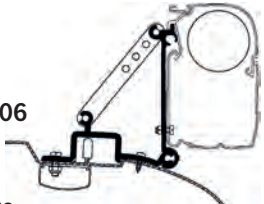
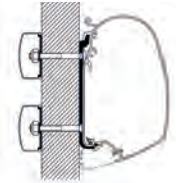
## Wall mounting adapter for motorhomes and caravans

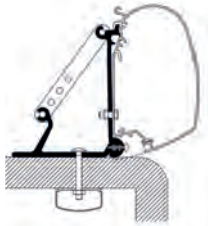
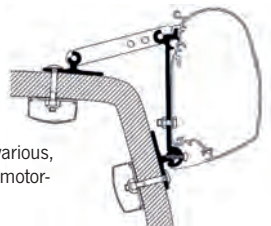
<p><b>NEW</b></p> <p>TO 4200 TO 5200 TO 8000</p>  <p><b>Hymer 2016</b> with improved mounting option for an LED strip</p> <p>260 cm <b>426981</b> <b>222,-</b> 300 cm <b>426982</b> 222,- 350 cm <b>426983</b> <b>248,-</b></p> <p>400 cm <b>430634</b> 285,- 450 cm <b>E10323</b> 350,- 500 cm <b>E6530</b> 350,- 550 cm <b>E10345</b> 419,- 600 cm <b>426984</b> 419,-</p>	<p>TO 4200 TO 5200 TO 8000</p> <p><b>Hymer C-Camp ≤ 2011</b></p> <p>300 cm <b>E1691</b> 222,- 350 cm <b>43101</b> 248,- 400 cm <b>43102</b> 285,- 450 cm <b>43104</b> 350,- 500 cm <b>43103</b> 350,- 550 cm <b>43100</b> 419,-</p> 	<p>TO 4200 TO 5200 TO 8000</p>  <p><b>Hymer B2 - VAN</b></p> <p>350 cm <b>43110</b> 248,- 400 cm <b>43111</b> 285,- 450 cm <b>43112</b> 350,- 500 cm <b>43113</b> 350,-</p>	<p>TO 4200 TO 5200</p>  <p><b>Eriba Touring &lt; 2007</b> 3x4 cm 3 Holder <b>43108</b> 129,-</p>
<p>TO 5200</p>  <p><b>Bürstner 2017</b> 2x40 cm + 2x8 cm 4 Holder <b>43007</b> 108,-</p>	<p>TO 5200 TO 8000</p>  <p><b>Wall adapter Frankia</b></p> <p>350 cm <b>430601</b> 248,- 400 cm <b>430602</b> 285,- 450 cm <b>430603</b> 350,- 500 cm <b>430604</b> 350,- 550 cm <b>430605</b> 419,- 600 cm <b>430606</b> 419,-</p>	<p>TO 4200 TO 5200 TO 8000</p>  <p><b>Dethleffs Globebus</b></p> <p>300 cm <b>430790</b> 47,- 350 cm <b>43079</b> 61,- 400 cm <b>43080</b> 79,90 &gt; 400 cm <b>430801</b> 79,90</p>	<p>TO 4200 TO 5200 TO 8000</p>  <p><b>Carado / Sunlight</b> 1x17,5cm + 1x40cm + 1x4cm 3 Holder <b>43135</b> 172,-</p>
<p>TO 5200</p>  <p><b>Knaus Tourer CUV</b> 300 cm <b>426791</b> 222,-</p>	<p>TO 5200</p>  <p><b>Knaus 2017</b> 2x17,5 cm + 2x4 cm 4 Holder <b>43005</b> 108,-</p>	<p>TO 5200</p>  <p><b>Knaus Deseo</b> 350 cm <b>43006</b> 407,-</p>	<p>TO 4200 TO 5200</p>  <p><b>Bailey</b> Awning width 400-450 cm, not for motorhome Autograph 81-6, for caravans only w/ TO 4200, 5 holders à 15 cm. <b>426783</b> 160,-</p>
<p>TO 5200</p>  <p><b>Hobby Optima Ontour</b> 2x40 cm + 2x8 cm 4 Holder <b>43008</b> 158,-</p>	<p>TO 4200 TO 5200 TO 8000</p>  <p><b>Rapido 9</b> 4 Holder <b>SA444</b> 91,-</p>	<p>TO 4200 TO 5200 TO 8000</p>  <p><b>Pilote Explorateur</b> 400 cm <b>E2957</b> 285,-</p>	<p>TO 4200 TO 5200 TO 8000</p>  <p><b>Eden / Allegro ≤ 2010</b> 3 Holder <b>E8782</b> 129,- 400 cm <b>E8074</b> 285,-</p>
<p>TO 4200 TO 5200 TO 8000</p>  <p><b>Rapido 7</b> 400 cm <b>SA174</b> 285,- 500 cm <b>E4577</b> 350,-</p>	<p>TO 3200 TO 4200 TO 5200</p>  <p><b>Fiat Ducato &lt; 2006</b> Fiat Ducato, Peugeot Boxer, Citroen Jumper for series high roof H2 3 Holder <b>426786</b> 104,-</p>	<p><b>Universal Flat Adapter</b></p> <p>5 x 40 cm <b>430415</b> 145,- 5 x 75 cm <b>E7099</b> 160,- 300 cm <b>SA865</b> 197,- 400 cm <b>430416</b> 253,- 500 cm <b>430417</b> 314,- 600 cm <b>E4957</b> 373,-</p> 	<p>TO 4200 TO 5200 TO 8000</p>
<p>TO 5200</p>  <p><b>Ducato H2 Lift Roof</b> 315 cm <b>430637</b> 329,- 375cm <b>430638</b> 359,- 400 cm <b>430639</b> 359,-</p>	<p>TO 3200 TO 4200 TO 5200</p>  <p><b>Omni Roof</b> Universal roof adapter for mounting on the roof of motorhomes / caravans, 3 x 8 cm 3 Holder <b>426785</b> 129,-</p>	<p>TO 3200 TO 4200 TO 5200</p>  <p><b>Omni Wall</b> Universal adapter for various, universal attachment to motorhomes / caravans, 2 x 8 cm + 1 x 4 cm 3 Holder <b>426784</b> 124,-</p>	<p>TO 3200 TO 4200 TO 5200</p>

**Wall mounting adapter for panel vans and buses**

TO 3200

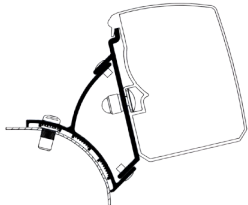

**Volkswagen Transporter 5/6 Fixed**  
For fixed mounting on Volkswagen bus.

42690	138,-
UK 42696	138,-

TO 4200  
TO 5200



**Volkswagen Transporter 4/5 Minivan Fixed**  
For sleeping roof

426702	138,-
UK 426703	138,-

**Adapter for the Reimo Multirail**

For Volkswagen Transporter 5/6/6.1 and awning TO 3200:

Short wheelbase	42691	217,-
Long wheelbase	42697	225,-
UK short wheelbase	426911	217,-
UK long wheelbase	426971	225,-

Also with folding sleeping roof

For Volkswagen Transporter 5/6/6.1 and awning TO 4200:

Short wheelbase	426704	217,-
Long wheelbase	426706	225,-
UK short wheelbase	426705	217,-
UK long wheelbase	426707	225,-

For Mercedes-Benz Vito and TO 4200 awning with REIMO sleeper roof

426766	319,-
--------	-------

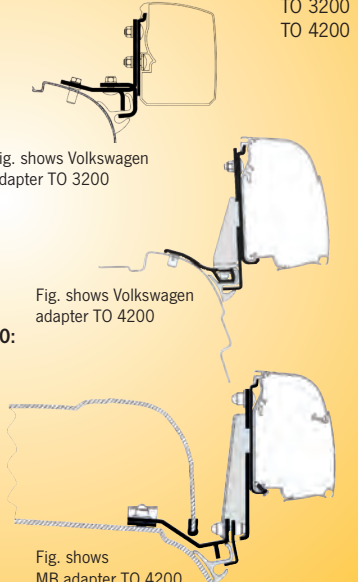



Fig. shows Volkswagen adapter TO 3200

Fig. shows Volkswagen adapter TO 4200

Fig. shows MB adapter TO 4200

**NEW** TO 3200



**Volkswagen Transporter 4**  
For fixed mounting on the VW bus. for awning width 250 cm. 2 holders.

426789	169,-
--------	-------

**NEW** TO 3200



**Volkswagen Transporter 2 / 3**  
For fixed mounting on the VW bus for awning width 250 cm. 2 holders.

426788	169,-
--------	-------

TO 3200  
TO 4200  
TO 5200



**Volkswagen T4 Sleeping roof adapter**  
2 holders à 8 cm.

43026	121,-
-------	-------

TO 3200

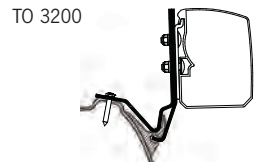

**Westfalia Kepler Five/One/Six**  
Five = 270 cm  
One & Six = 300 cm

426758	169,-
--------	-------

TO 4200

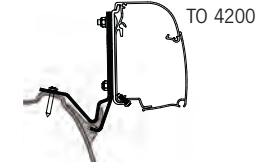

**Westfalia Kepler Five/One/Six**  
Five = awnings 260 cm  
One & Six = awning 300 cm

426712	169,-
--------	-------

TO 3200



**Volkswagen T5/T6 Brandrup**  
For mounting on a Brandrup rain gutter.

42692	169,-
-------	-------

TO 4200  
TO 5200

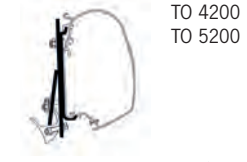

**Brandrup T4/T5/T6 Brandrup Rail**, for special rain gutter. 2 holders à 8 cm.

43025	113,-
-------	-------

Also suitable for UK

TO 4200  
TO 5200



**Volkswagen T4 Brandrup Rail G2**  
to screw on

430607	169,-
--------	-------

TO 4200  
TO 5200



**Westfalia adapter**  
For vehicles with high roof and side mounting points. 3 holders à 8 cm.

430633	101,-
--------	-------

TO 4200  
TO 5200



**Westfalia Ford Nugget**  
2 holders à 12 cm. For awning 260 cm.

430600	101,-
--------	-------

TO 4200  
TO 5200  
TO 8000

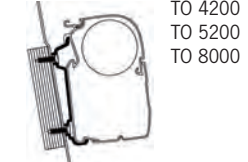

**Ford Transit High roof adapter**, 3 holders: 2x50 cm + 1x50 cm

E2069	91,-
-------	------

TO 3200



**Ford Custom 2012-2024**  
Fixed mounting on Ford Transit/Tourneo Custom.

42694	169,-
UK 42679	169,-

TO 3200 TO 4200 **NEW**

**Ford Transit Custom ≥ 2024**  
Ford Transit Custom V710, L1 + L2  
Awning widths: TO 3200=270 cm or 300 cm, TO 4200=260 cm or 300 cm, 2 brackets,

TO 3200	426970	169,-
TO 3200 UK	426972	169,-
TO 4200	426796	169,-
TO 4200 UK	426797	169,-

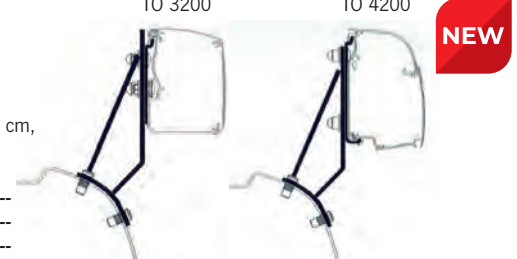

TO 4200  
TO 5200

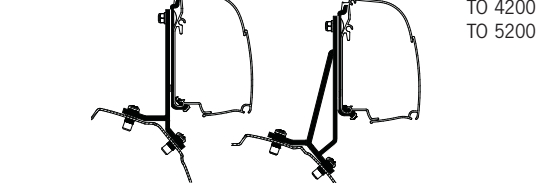

**Ford Transit/Tourneo Custom Minivan Fixed**

426710	169,-
UK 426711	169,-

TO 5200

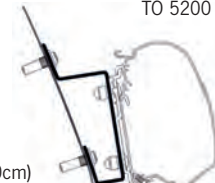

**Ford Transit H3**  
for Transit ≥ 2014, 3 holder  
Awning width 300 cm for Transit L2 (550cm)  
Awning width 350 cm for Transit L3 (600cm)  
Awning width 400 cm for Transit L4 (670cm)

UK 426776	197,-
UK 426777	197,-

TO 5200  
TO 4200

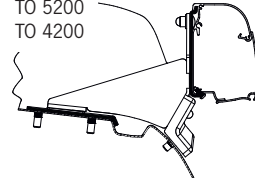

**Mercedes Vito/V-Class with SCA pop-up roof 152**  
For awnings 260 cm

426713	189,-
--------	-------



Wall mounting adapter for panel vans and buses

TO 3200



**PSA Minivan G2**  
for vehicle length 495 cm, 2 brackets, awning width TO 3200=270 cm,  
Peugeot Traveller/Expert ≥ 16  
CitroënSpacetourer/Jumpy ≥ 16  
Fiat Scudo ≥ 16  
Toyota Proace (Verso) ≥ 16  
Opel Zafira/Vivaro ≥ 19

**NEW**

TO 3200	426778	189,-
TO 3200 UK	426779	189,-

TO 3200



**NEW**

**Citroën Holidays** with MAX package (incl. piping rail).  
for awning width 270 cm

426973	169,-
--------	-------

TO 3200

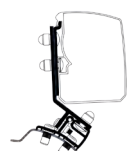

**CitroënSpacetourer**  
Peugeot Traveller, Toyota Verso & Opel Zafira D.

42693	169,-
UK 42699	169,-

TO 3200  
TO 4200  
TO 5200  
TO 8000



**Renault / Opel Adapter Renault Master < 2010, Opel Movano**  
Standard high roof ≥ 1998,  
3 Holder 426787 197,-

High roof H3 TO 4200  
TO 5200  
TO 8000



**Renault / Opel Adapter Renault Master < 2010, Opel Movano with high roof.** 2 holders à 50 cm  
430630 138,-

Also suitable for UK TO 4200  
TO 5200



**Renault / Opel**  
Renault Traffic all YOC., Opel Vivaro < 2019.  
With and without pop-up roof.  
Awning width max. 260 cm  
2x50 cm. 43105 129,-

TO 3200

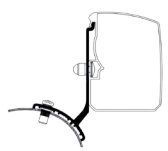

**Renault Traffic**  
Fixed mounting also on Vivaro/  
Talentó/NV300.  
Also suitable for UK.  
42695 129,-

TO 3200  
TO 4200  
TO 5200



**Van adapter** 2 angles possible  
For vehicles with rain gutter,  
2 holders each 4 cm & 8 cm.  
Incl. 2 different angles.  
43051 121,-

TO 4200  
TO 5200



**Fiat Ducato & Iveco Adapter Fiat Ducato H2 w/ folding sleeping roof.**  
3 holder à 17,5 cm  
430631 172,-

TO 4200  
TO 5200



**Fiat ≥ 2007 - H3 Adapter Fiat Ducato and similar with H3 series roof.**  
Incl. Sealing tape.  
3 holders: 2x50 cm + 1x10 cm  
430632 138,-

TO 3200



**Wall Adapter Flat Wall**  
Also suitable for UK.  
42688 56,-

TO 3200



**Roof adapter Roof Rack**  
Also suitable for UK.  
42689 98,-



Photo shows a.o. "Subsola triangular sail"



Thule Omnistor 1200  
large pullout in compact envelope



**THULE Omnistor 1200 - Caravan awning in a case**

- Attachment by pulling into the keder rail
- Toolless assembly
- Easy and fast set up
- Support legs and clamping arms in front bar
- Cover and cloth made of high quality PVC
- New type of fabric tensioning system w/ ratchet
- Additional support foot for awnings from 400 cm

The Thule Omnistor 1200 is an extremely lightweight and strong pocket awning in compact PVC cover with sewn piping and zipper. The assembly is done simply by pulling in the Bag into the welt rail - without tools, without drilling.

Wide	230 cm	260 cm	300 cm	325 cm	350 cm	375 cm	400 cm	425 cm	450 cm	500 cm	550 cm
<b>Pull-out</b>	200 cm	220 cm	250 cm	250 cm	250 cm	250 cm	250 cm	250 cm	250 cm	250 cm	250 cm
<b>Weight</b>	9 kg	10,4 kg	12 kg	12,6 kg	13,4 kg	14,2 kg	15 kg	15,3 kg	16,6 kg	18,4 kg	20 kg
Mystic Grey	42416	42400	42402	42404	42406	42408	42410	42412	42414	42418	42420
Saphir Blue	42417	42401	42403	-	42407	42409	42411	42413	42415	42419	42421
<b>Price</b>	549,-	559,-	569,-	579,-	599,-	619,-	659,-	699,-	749,-	799,-	849,-



**Support Kit**  
The pressure of the clamping arms is evenly distributed on the caravan wall.



**Cloth tensioning system**  
Perfect tension of the cloth with the help of the new ratchet technology



**Additional support foot** additional for awnings from 4 m  
**E5049 84,-**

**Accessories for Thule Omnistor 1200**  
Thule QuickFit awning tent S. 178  
Thule Sun- and Rainblocker S. 176-177  
Tie rods and accessories S. 181

**THULE Subsola**

- Modular panels developed for small vans and buses
- Perfect weather protection

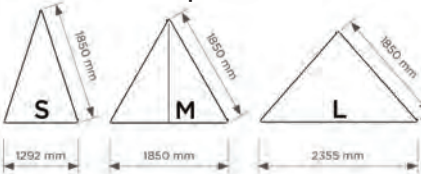

The Thule Subsola Tarps are compatible with the following Thule awnings:  
• Thule Omnistor 4200, 4900 and 5102  
• Volkswagen awning from T5/T6 California  
• Thule Omnistor 5200 w/ width 260 cm & extension 200 cm

Thule Subsola are made of breathable & water-resistant material & offer protection from sun and rain. They have high-quality zippers and piping and can be attached and combined in different ways. Suitable for mounting heights from 190 to 224 cm. Color: Vapor Grey.

**Additional Subsola MEDIUM panel (M)**  
**430894 134,-**

**Thule Subsola support bar**  
consisting of: 1 x extension pole L approx. 240 cm, telescopic **430895 74,-**



Photo shows Set Subsola front



Photo shows Set Subsola side

	Set Subsola side	Set Subsola front
<b>Subsola SMALL panel (S)</b>	1	-
<b>Subsola MEDIUM panel (M)</b>	2	1
<b>Subsola LARGE panel (L)</b>	-	1
<b>Tension rod</b>	1	-
<b>Set-up pole, L approx. 240 cm</b>	1	1
<b>Guy ropes and pegs bag</b>	1	1
<b>Pack size</b>	app. 80 x 16 x 16 cm	app. 31 x 6 x 6 cm
<b>Weight</b>	app. 4,5 kg	approx. 3.0 kg
<b>Art. no.</b>	<b>430892</b>	<b>430893</b>
<b>Price</b>	<b>429,-</b>	<b>279,-</b>



Photo shows Subsola pole





**Modular, combinable blocker system G2**

- Side parts (Side) incl. aluminum tension rod for fastening
- With keder profile for retracting the side wall
- Delivery includes pegs and guy ropes
- Front wall (front) is pulled into the keder rail of the awnings

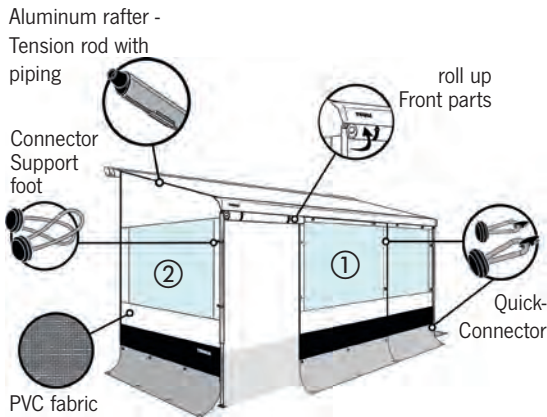

**Sun Blocker G2**

- Lightweight translucent mesh fabric
- Protection against sun rays
- Side panels incl. aluminum tension rod for fastening w/ keder profile for retracting side panel

**③ Sun Blocker G2 Side - side panel**

Awning type	Pull-out	Type	Mounting height	Item no.	Price
T 3200 (Van/SUV)	250 cm	XS	180 -199 cm	<b>430802</b>	<b>242,-</b>
TO 5200/5003/5102/6200/6300	200 cm	S	190 -224 cm	<b>430880</b>	<b>242,-</b>
TO 5200/5003/6200/6300	250 cm	M	225 -244 cm	<b>430851</b>	<b>242,-</b>
TO 5200/5003/6200/6300	250 cm	L	245 -264 cm	<b>430852</b>	<b>242,-</b>
TO 6900/8000	275 cm	L	245 -264 cm	<b>430854</b>	<b>262,-</b>
TO 9200	300 cm	M	225 -244 cm	<b>430855</b>	<b>292,-</b>
TO 9200	300 cm	L	245 -264 cm	<b>430856</b>	<b>292,-</b>
TO 1200	250 cm	M	225 -249 cm	<b>430882</b>	<b>242,-</b>

**④ Sun Blocker G2 Front - Front Wall**

Awning type	Wide	Height	Item no.	Price
	100 cm	170 cm	<b>430873</b>	<b>129,-</b>
	240 cm	170 cm	<b>430874</b>	<b>154,-</b>
for all	280 cm	170 cm	<b>430875</b>	<b>169,-</b>
Thule Omnistor	330 cm	170 cm	<b>430876</b>	<b>184,-</b>
Awnings	380 cm	170 cm	<b>430877</b>	<b>194,-</b>
	430 cm	170 cm	<b>430878</b>	<b>204,-</b>
	480 cm	170 cm	<b>430879</b>	<b>224,-</b>



**View Blocker perfect Privacy screen**

- Protection against Rain, Wind & Sun
- Made of weatherproof PVC
- Side panels incl. aluminum tension rod for fastening w/ keder profile for retracting side panel

**⑤ View Blocker Side - side panel**

Awning type	Pull-out	Type	Mounting height	Item no.	Price
TO 5200/5003/6200/6300	200 cm	S	205-224 cm	<b>430887</b>	<b>257,-</b>
TO 5200/5003/6200/6300	250 cm	S	205-224 cm	<b>430888</b>	<b>257,-</b>
TO 5200/5003/6200/6300	250 cm	M	225-244 cm	<b>430831</b>	<b>257,-</b>
TO 1200/5200/5003/6200/6300	250 cm	L	235-254 cm	<b>430886</b>	<b>257,-</b>
TO 5200/5003/6200/6300	250 cm	L	245-264 cm	<b>430832</b>	<b>257,-</b>



**⑥ View Blocker Front - Front panel**

Awning type	Wide	Height	Item no.	Price
	240 cm	140 cm	<b>430822</b>	<b>144,-</b>
	280 cm	140 cm	<b>430823</b>	<b>149,-</b>
for all	330 cm	140 cm	<b>430824</b>	<b>154,-</b>
Thule Omnistor	380 cm	140 cm	<b>430825</b>	<b>159,-</b>
Awnings	430 cm	140 cm	<b>430826</b>	<b>189,-</b>
	480 cm	140 cm	<b>430827</b>	<b>209,-</b>



**Thule Windscreen - Wind protection for all awning types**

Self rolling windbreak made of easy-care PVC fabric.

150 cm high and extendable up to 300 cm. Quickly attaches the windshield to the support leg wall bracket or vehicle keder rail. Simply unroll and attach to awning support foot or free-standing with the supplied bracing set set up.

Includes carrying bag and Mounting material, guy ropes and herrings.

Weight 4,5 kg

Pack size 160 x 10 x 12 cm



44590

242,-

Usable for all types of awnings



**Rain Blocker G2 Front parts**

- Made of waterproof PVC with large window
- St protects from sun, wind and rain
- Different width front parts can be combined with each other

**① Rain Blocker G2 Front - Front wall**

Awning type	Wide	Height	Item no.	Price
Combinable with Side XS	112 cm	185 cm	<b>430804</b>	<b>154,-</b>
Suitable also for T 3200 and TO 4200	127 cm	185 cm	<b>430841</b>	<b>159,-</b>
	147 cm	185 cm	<b>430806</b>	<b>169,-</b>
	181 cm	185 cm	<b>430807</b>	<b>189,-</b>
	125 cm	210 cm	<b>430842</b>	<b>159,-</b>
Combinable with Side S and TO 1200	150 cm	210 cm	<b>430843</b>	<b>169,-</b>
	175 cm	210 cm	<b>430844</b>	<b>189,-</b>
	200 cm	210 cm	<b>430845</b>	<b>204,-</b>
	100 cm	230 cm	<b>430857</b>	<b>149,-</b>
Combinable with Side M, L, XL, XXL and G2C (Caravan)	150 cm	230 cm	<b>430858</b>	<b>169,-</b>
	175 cm	230 cm	<b>430859</b>	<b>189,-</b>
	200 cm	230 cm	<b>430860</b>	<b>204,-</b>

Also for Volkswagen Transporter 5/6



**Rain Blocker G2 Side panels**

- Made of waterproof PVC w/ panoramic window
- St protects from sun, wind and rain
- Side panels incl. aluminum tension rod for fastening w/ keder profile for retracting side panel

**② Rain Blocker G2 Side - side panel**

Awning type	Pull-out	Type	Mounting height	Item no.	Price
T 3200 (Van/SUV)	250 cm	XS	180 -199 cm	<b>430803</b>	<b>257,-</b>
TO 5200/4200/5102/VW California	200 cm	XS	180 -199 cm	<b>430883</b>	<b>257,-</b>
TO 5200/5003/5102/6200/6300	200 cm	S	205 -224 cm	<b>430881</b>	<b>257,-</b>
TO 5200/5003/6200/6300	250 cm	S	205 -224 cm	<b>430861</b>	<b>257,-</b>
TO 5200/5003/6200/6300	250 cm	M	225 -244 cm	<b>430862</b>	<b>257,-</b>
TO 5200/5003/6200/6300	250 cm	L	245 -264 cm	<b>430863</b>	<b>257,-</b>
TO 5200/5003/6200/6300	250 cm	XL	265 -284 cm	<b>430864</b>	<b>257,-</b>
TO 5200 Fiat Ducato H2	250 cm		230 -250 cm	<b>430891</b>	<b>257,-</b>
TO 6200/6300 (Caravan)	200 cm	G2C	235 -254 cm	<b>430889</b>	<b>257,-</b>
TO 6200/6300 (Caravan)	250 cm	G2C	235 -254 cm	<b>430800</b>	<b>257,-</b>
TO 8000	275 cm	M	225 -244 cm	<b>430865</b>	<b>277,-</b>
TO 8000	275 cm	L	245 -264 cm	<b>430866</b>	<b>277,-</b>
TO 8000	275 cm	XL	265 -284 cm	<b>430867</b>	<b>277,-</b>
TO 8000	275 cm	XXL	285 -304 cm	<b>430884</b>	<b>277,-</b>
TO 9200	300 cm	M	225 -244 cm	<b>430868</b>	<b>307,-</b>
TO 9200	300 cm	L	245 -264 cm	<b>430869</b>	<b>307,-</b>
TO 9200	300 cm	XL	265 -284 cm	<b>430870</b>	<b>307,-</b>
TO 9200	300 cm	XXL	285 -304 cm	<b>430885</b>	<b>307,-</b>
TO 6200/6300 - Fiat Ducato	250 cm		230 -250 cm	<b>430872</b>	<b>257,-</b>



Awning QuickFit  
also for FIAT Ducato  
on page 164

**Quick pitch tent to hang under**

- Universal fit - suitable for almost any type of awning
- Light weight, small pack size
- Is hung under the awning, creating a double insulating roof
- Round arch canopy protects during rain
- Includes floor skirt, curtains & bag
- Front window can be opened completely

**Scope of delivery:**

Tent, pack bag (measure app. 70 x 35 x 35 cm), pegs, Curtains & windbreak to prevent drafts under the vehicle.



**Only 15 minutes assembly time**

**Thule QuickFit**

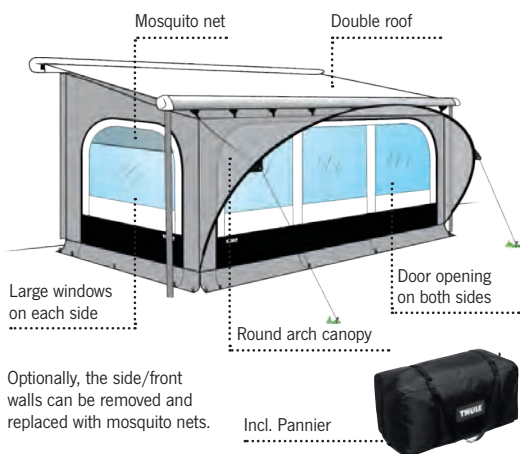

**Thule QuickFit - awning tent for ultrafast assembly**

Tent width	Mounting height	in cm	for awning width	Weight	Art. no.	Price
260 cm	Medium	225 – 244	300 cm	15,7 kg	43214	919,-
260 cm	Large	245 – 264	300 cm	16,1 kg	432140	939,-
260 cm	Extra-Large	265 – 284	300 cm	16,4 kg	4321411	959,-
310 cm	Medium	225 – 244	350 cm	16,7 kg	432148	949,-
310 cm	Large	245 – 264	350 cm	17,1 kg	432149	969,-
310 cm	Extra-Large	265 – 284	350 cm	17,4 kg	4321412	989,-
360 cm	Medium	225 – 244	400 cm	17,7 kg	432141	979,-
360 cm	Large	245 – 264	400 cm	18,1 kg	432142	999,-
360 cm	Extra-Large	265 – 284	400 cm	18,4 kg	4321413	1019,-

**Assembly note**

Mounting is possible under the awning if ...  
 ... a roof or wall awning is installed and an 8 mm keder rail is still accessible underneath.  
 ... an awning is installed and there is no keder rail underneath. However, then a Mounting set necessary.

**Accessories for awning QuickFit**



**Side Tensioning Kit**

Fixation set consisting of two flex rods for additional bracing of the side walls.

432147 50,-



The windows can be replaced with mosquito inserts.  
How to create an airy living space

**Mosquito net inserts**

for side wall	432150	184,-
for front wall 260 cm	4321501	209,-
for front wall 300/310 cm	4321502	219,-
for front wall 360 cm	4321503	229,-

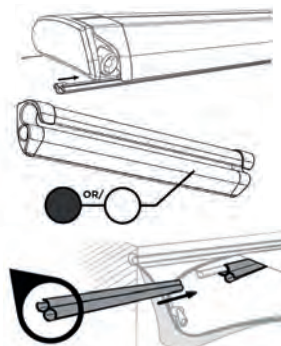

**Mounting sets QuickFit**

**...Roof awnings**

Thule Omnistor 6200, 6300 and 9200 up to 400 cm wide.  
3 rails à 130 cm

432143 50,-

**Side wall awnings**

Keder rail in 400 cm length  
 White 4321430 50,-  
 Anthracite 4321431 50,-

**...Caravan awnings**

Thule Omnistor 1200 to 450 cm  
 Awning width 4321471 50,-

**Mounting kit for awnings with extension over 250 cm**



For mounting on awnings with an extension 275 cm to 300 cm. The greater distance is bridged with this set. 8 parts

432146 30,-

**Mounting set for FIAMMA awnings**



Special set for mounting the tent on Fiamma awnings.  
8 parts. 4321470 30,-

# Thule Residence G3

## Exclusive awning awning

- **High quality cloth material made of PVC**  
Excellent PVC cloth quality for optimal wind and water resistance in the colors black, Grey and white.
- **Robust sealing**  
A profile with double rubber lips creates a perfect seal between the vehicle wall and the tent walls. Thanks to connecting profiles, front and side walls can be combined to form a closed tent.
- **Installation**  
A clamping profile ensures the connection of the side wall with the awning cloth for a perfect roof seal. The side panels slide into the clamping profile, the front panel is pulled into the front profile of the awning. From a width of 350 cm, the door can be used on the left or right.
- **Protection**  
Side windows are fitted w/ a window film that can be opened w/ a zipper from the outside. For insect protection, a fly gauze is standard on both side walls.



Incl. Packing bags for tent skin, poles & accessories



Color combination



- 1 Incl. Windshield and Wheel cover
- 2 Side windows w/ mosquito nets and foil cover
- 3 Front wall w/ door right or left from width 350 cm
- 4 Windows in front and door can be rolled up
- 5 Piping on front to accommodate accessories, such as Sun Blocker

DUC = sizes for Fiat Ducato H2  
FT = sizes for Ford Transit H3

### Residence G3 for Eriba Touring



#### Complete tent

A true outdoor living room. Special model for an Eriba Touring caravan in combination with Thule Omnistor 6300 roof awning (for 325 cm). Incl. Wind skirt, wheel cover and pannier.

433010 2035,-

### Residence G3 complete tent



For mounting Volkswagen Transporter 5/6 or California with short wheelbase or MB Vito. Front, side panels and all mounting parts. Width 260 cm.

for TO 5102 433012 1835,-  
for TO 4200 42925 1835,-

### Accessories for Thule Residence G3:

Curtain sets	see below
Thule Sun Blocker Front G2	S. 177
Windshield (as a replacement)	S. 181
Connection profiles for accessories	
Double piping 6 x 1m	42908 57,-

### Side walls (in pairs, only for vehicles with straight walls)

Mounting height Awning	TO 5003/5200		TO 6200/6300		TO 6900		TO 8000		TO 9200	
	Extension 250 cm	Price	Extension 250 cm	Price	Extension 275 cm	Price	Extension 275 cm	Price	Extension 300 cm	Price
S (215 - 230 cm)	42901	1499,-	429011	1499,-	—	—	429014	1649,-	—	—
M (230 - 245 cm)	42902	1499,-	429021	1499,-	429022	1649,-	429024	1649,-	429025	1749,-
DUC (230 - 250 cm)	42900	1499,-	42900	1499,-	—	—	—	—	—	—
FT (245 - 264 cm)	42924	1499,-	—	—	—	—	—	—	—	—
L (245 - 260 cm)	42903	1499,-	429031	1499,-	—	—	429034	1649,-	429035	1749,-
XL (260 - 275 cm)	42904	1549,-	429041	1549,-	429042	1699,-	429044	1699,-	429045	1799,-
XXL (275 - 290 cm)	42905	1599,-	429051	1599,-	429052	1749,-	429054	1749,-	429055	1849,-
3XL (290 - 310 cm)	42906	1699,-	429061	1699,-	429062	1849,-	429064	1849,-	429065	1949,-

### Front walls

Awning width	300 cm	315 cm	325 cm	350 cm	375 cm	400 cm	425 cm	450 cm	500 cm	550 cm	600 cm
Heights S, M, L, XL	42915	—	429151	429152	429153	429154	429155	429156	429157	429158	429159
Price	599,-	—	649,-	649,-	699,-	699,-	750,-	750,-	860,-	910,-	960,-
Heights DUC & FT	42919	42918	42920	42921	42922	42923	—	—	—	—	—
Price	599,-	650,-	650,-	650,-	699,-	699,-	—	—	—	—	—
Heights XXL, 3XL	42916	—	429161	429162	429163	429164	429165	429166	429167	429168	429169
Price	720,-	—	770,-	770,-	820,-	820,-	870,-	870,-	980,-	1030,-	1080,-

### Curtain sets for Residence G3 - fabric color Grey

Wide	Color grey	Price
350 - 400 cm	42912	234,-
425 - 500 cm	42913	254,-
550 - 600 cm	42914	274,-

### Weights:

The weight for a complete tent in 300 cm medium is about 27.0 kg, at 600 cm Large approx. 35.5 kg.





Panorama awning also for FIAT Ducato with TO 6300 see page 164



Optionally, the side walls can be removed and replaced by mosquito nets



Black Silver White

Color combination

**Panorama - Premium Complete awning tent for Thule Omnistor awnings**

Awning-type	Mounting height of the awning (to lower edge of housing)	Awning width													
		300 cm	Price	350 cm	Price	400 cm	Price	450 cm	Price	500 cm	Price	550 cm	Price	600 cm	Price
8000	Medium (230 - 244 cm)	—	—	—	—	43182	3199,-	431821	3199,-	431822	3280,-	431823	3280,-	431824	3360,-
	Large (245 - 259 cm)	—	—	—	—	43183	3199,-	431831	3199,-	431832	3280,-	431833	3280,-	431834	3360,-
	Extra-Large (260 - 274 cm)	—	—	—	—	431835	3280,-	431836	3280,-	431837	3360,-	431838	3360,-	431839	3440,-
9200	Medium (230 - 244 cm)	—	—	—	—	43195	3360,-	431951	3360,-	431954	3440,-	431955	3440,-	—	—
	Large (245 - 259 cm)	—	—	—	—	43196	3360,-	431961	3360,-	431964	3440,-	431965	3440,-	431966	3520,-
	Extra-Large (260 - 274 cm)	—	—	—	—	431967	3440,-	431968	3440,-	431969	3520,-	431970	3520,-	431971	3599,-
5200	Medium (230 - 244 cm)	431870	2720,-	431871	2799,-	431872	2880,-	431873	2960,-	431881	3040,-	—	—	—	—
5300	Large (245 - 259 cm)	431874	2720,-	431875	2799,-	431876	2880,-	431877	2960,-	431880	3040,-	—	—	—	—
	Extra-Large (260 - 274 cm)	—	—	—	—	431878	2960,-	431879	3040,-	431882	3120,-	—	—	—	—
6002	Medium (230 - 244 cm)	43184	2720,-	431841	2799,-	431842	2880,-	431843	2960,-	—	—	—	—	—	—
6200	Large (245 - 259 cm)	43185	2720,-	431851	2799,-	431852	2880,-	431853	2960,-	—	—	—	—	—	—
6300	Extra-Large (260 - 274 cm)	—	—	—	—	431854	2960,-	431855	3040,-	—	—	—	—	—	—

**Panorama - complete awning for Opel Movano ≥ 2022, Fiat Ducato & similar**

Awning-type	Mounting height of the awning (to lower edge of housing)	Awning width									
		300 cm	Price	315 cm	Price	350 cm	Price	375 cm	Price	400 cm	Price
5200	230 - 250 cm	431883	2720,-	431884	2799,-	431885	2799,-	431886	2880,-	431887	2880,-
6200	230 - 250 cm	—	—	431791	2800,-	—	—	431792	2880,-	431793	2880,-



**Mosquito net inserts for Panorama**

Mosquito net side wall	432736	304,-
Mosquito net front wall (for 400-600 cm)	432737	284,-

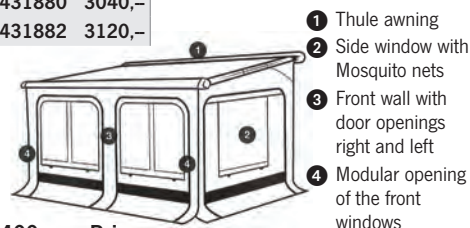

**Thule Veduta**

**Awning awning for caravan**

Use only in combination with a roof awning TO 6300/6200 mounted on the caravan (mounting height 245-259 cm). With sloping front wall for maximum living space and extra sense of space.

- **Cloth material AIRTEX®**  
AIRTEX® is ideal for awnings. The lightweight fabric (200g/m<sup>2</sup>) is made of 100% polyester and is coated on one side with acrylate and impregnated.
- **Versatility**  
All window panels can be removed. One side wall has two integrated door openings for rolling up at the side. All windows are equipped with mosquito nets. The mosquito net is equipped with transparent covers that can be opened and rolled up by zippers. The front wall consists of one piece with two large windows.

**Awning Thule Veduta**

Width 400 cm	431825	3180,-
Width 425 cm	431826	3260,-
Width 450 cm	431827	3260,-
Width 500 cm	431828	3340,-

- **Included**  
The floor has a double windbreak to protect against dirt and rain. Wind skirt and wheel cover included. Two panniers.
- **Accessories**  
Sun Blocker Page 176  
Garda set 42914 274,-



**Foam tape**

seals space between vehicle and awning. 2 parts of 2 meters each. Closed-pored and self-adhesive. Dimensions: 25 x 30 mm  
**43292 55,-**



**Sealing rubber for TO 4200**

For sealing to the vehicle. Can also be used with other awnings. With double adhesive tape. Length 400 cm **432805 64,-**

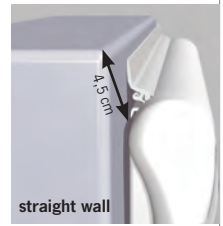
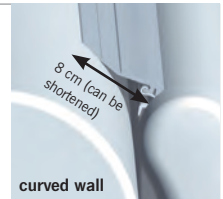

**Sealing rubber for series 5 and 8**

For sealing the gap between the vehicle wall and the awning, for awning installation with flat adapters.

Gcurved walls			Straight walls		
400 cm	<b>432802</b>	<b>59,-</b>	400 cm	<b>432803</b>	<b>59,-</b>
30 m roll	<b>43295</b>	<b>330,-</b>	30 m roll	<b>432951</b>	<b>330,-</b>

**Omni-Gutter rain gutter**

Multifunctional self-adhesive rain gutter. Length 350 cm **432806 64,-**  
 Length 450 cm **43031 74,-**



**Panniers**

2 bags in the set to store awnings tents, blockers or accessories. Dimension large bag: 120 x 20 x 30 cm, small bag: 120 x 20 x 20 cm **E4610 80,-**  
 Panniers for stowing linkage and blockers. Dimension bag: 130 x 20 x 30 cm **42917 49,-**

**Curtain sets for awnings awnings**

**Curtain sets for Thule Residence G3**

Width B	Set Grey	Price
350 - 400 cm	<b>42912</b>	<b>234,-</b>
450 - 500 cm	<b>42913</b>	<b>254,-</b>
550 - 600 cm	<b>42914</b>	<b>274,-</b>



**AwningTension rods round**

to stabilize the awning. Also suitable as a receptacle for side panels. Aluminum (spring loaded and lockable).

**Thule Tension Rafter G2 Aluminum**

for side wall awnings		
200 cm for TO 5200/5003	<b>432973</b>	<b>59,-</b>
250 cm for TO 5200/5003	<b>432974</b>	<b>61,-</b>
275 cm for TO 8000	<b>432975</b>	<b>69,-</b>
for roof awnings		
200 cm for TO 6200/6300	<b>432976</b>	<b>59,-</b>
250 cm for TO 6200/6300	<b>432977</b>	<b>61,-</b>
300 cm for TO 9200	<b>432978</b>	<b>73,-</b>
for caravan awnings		
250 cm for TO 1200	<b>432972</b>	<b>61,-</b>

**Cloth clamps for tension rods**

Clamps for a more secure attachment of the awning fabric on the tensioning or Blocker rod. Suitable for oval blocker-Tensioning bars, rafter G2 and square-Telescopic clamping rod TO 1200. 2 piece **430068 39,-**



**Windbreaks for awnings**

Drafts can no longer pass under the vehicle.

for B 325 cm	<b>430760</b>	<b>83,-</b>
for B 350 cm	<b>430761</b>	<b>83,-</b>
for B 375 cm	<b>430762</b>	<b>85,-</b>
for B 400 cm	<b>43077</b>	<b>85,-</b>
for B 450 cm	<b>430771</b>	<b>87,-</b>
for B 500 cm	<b>43078</b>	<b>93,-</b>
for B 600 cm	<b>430782</b>	<b>96,-</b>

**Wheel cover orifice**  
**430783 63,-**

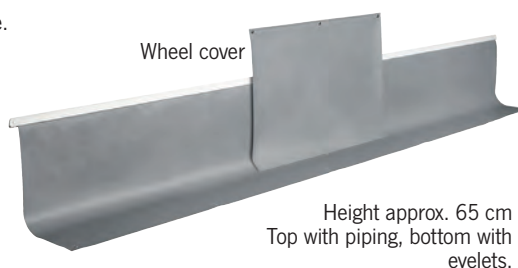

Wheel cover

Height approx. 65 cm  
 Top with piping, bottom with eyelets.

**Awning cleaner**

**Thule PVC cleaner**

for cleaning awning cloths. Practical pump spray bottle. Content 500 ml. **E6100 9,95**  
 GP 19,90/ 1 Liter



BP\* = Base price per specified unit



**Awning cranks**

  
Telescopic, from YOC. 1992  
**43159 60,60**  
for 6 series, adjustable 130-190 cm  
**43034 67,10**  
for awning 5102, foldable  
**43035 54,30**



**Retaining clips**  
for marker crank  
2 piece **E283 10,20**

**End caps**

for TO 2000  
White L **E235 16,54**  
for TO 5003  
White R+L **E2673 13,80**  
for TO 5102  
Gray R+L **E2067 24,90**  
Anthracite R+L **E5213 24,90**  
for TO 5200  
White R+L **E6507 24,90**  
Silver R+L **E6457 24,90**  
Black R+L **E8421 24,90**



for TO 8000  
White R **E2878 13,80**  
White L **E2875 13,80**  
Silver R **E3206 36,90**  
① Silver L **E3205 36,90**

**End plates**

for TO 5003  
Right **SA1117 18,70**  
for TO 5102  
Right **E2186 24,90**  
for TO 8000  
Left **E2874 105,30**  
① Right **E2877 40,20**

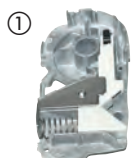

**Clamping lever**

for height adjustment at the awning foot incl. plastic cover.  
For models until 2010,  
2 piece **43158 11,50**  
For models from 2010,  
2 piece **E4181 13,90**



**End caps**

Fig. similar to

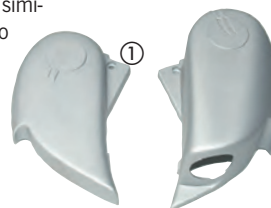

for TO 9200  
① Silver R+L **E5577 28,-**

**End caps front profile**

for TO 2000  
White R+L **E3651 12,40**  
for TO 5003  
White R+L **E3652 12,95**  
for TO 5102  
Gray R+L **E3476 14,60**  
Anthracite R+L **E5363 14,60**  
for TO 5200  
White R+L **E6586 18,-**  
Silver R+L **E10197 17,97**  
Black R+L **E10284 17,95**  
for TO 8000  
White R+L **E2876 13,20**

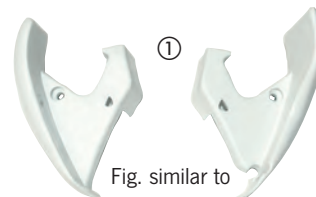

for TO 6200  
① White R+L **43144 18,-**  
Silver R+L **E9630 18,-**  
Anthracite R+L **E5482 18,-**

**Support foot holder**

for awning foot  
2 piece **43157 22,50**



**Interlocks**  
for 5000/5002

**43204 12,60**

**Rafter G2 end pieces**

**End pieces on the awning housing:**

for TO 5200/5002/5003/4900/  
5500/5800 **E54197,507,50**  
for TO 8000 **SA702 6,30**  
for TO 9200 **E8953 16,50**  
for TO 1200 **E8539 20,70**

**End pieces on the front profile:**

for TO 5200 **E6833 10,80**  
for TO 5003 **E4826 5,70**  
for TO 4900 **E5511 7,97**  
for TO 5002/5500/5800/8000  
**E8294 9,70**  
for TO 6200 **E5341 10,80**  
for TO 9200 **E9242 10,80**  
for TO 6900/6502/6802  
**E8294 9,70**

**Curtain rolls**

  
for Safari Room  
12 piece **E234 13,20**

**Double keder rail**

100 cm **E289 7,50**

**Crank gear**

①   
① For TO 5002/5003/5200  
**43192 65,70**  
For TO 6200 and 6300  
**E9261 65,70**

**Repair kit**

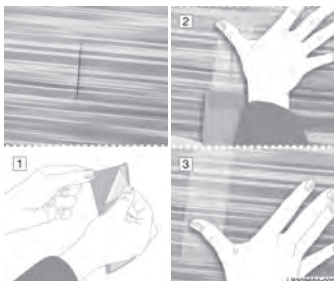

**Repair adhesive tape for awning cloth.**  
5 pieces à 50 x 145 mm  
**432891 29,-**

More spare parts  
at [www.reimo.com](http://www.reimo.com)

**Housing colors**

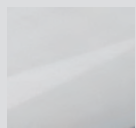

WHITE

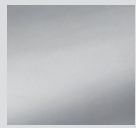

SILVER

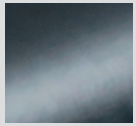

ANTHRACITE

**Cloth colors**



HORIZON GREY



GREY WAVES



**Roof awnings**  
Perfect Roof 2000 + 2500



**Mounting adapter for Perfect Roof 2000 and 2500 roof awnings**

**Fiat Ducato ≥ 2007**  
Ducato - Jumper - Boxer > 7/2006.

Also suitable for Niesmann Bischoff Arto and Rapido V53 & V56.

3-piece for awnings up to W 400 cm **438570 119,-**  
1pcs for awnings with W 375 cm **E3521 269,-**

Series high roof H2



**PR 2000 - The compact**

- Plastic end caps
- Support legs in the awning front rail
- Color-fast fabric without welded seam, made of one piece, waterproof, washable and rot-proof
- Ideal for Fiat Ducato

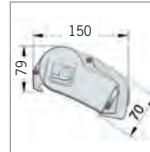

**PR 2500 - Large excerpt**

- Support legs with patented Easy Lock Flipper
- Aluminum end caps - shock and impact resistant

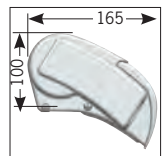

**Perfect Roof 2500 - Aluminum end caps**  
Wide 375 cm

**Housing silver with extension 250 cm**  
Grey Waves **438483**  
Price **975,-**

**Silver housing with large pull-out 275 cm**  
Horizon Grey **447332**  
Price **879,-**

**Sealing tape against Rainwater**

Foam sealing tape for Sealing between awning and vehicle, self-adhesive.

W 30 mm, H 25 mm. 2 x 1,5 m **439060 34,90**



**Perfect Roof 2000 - light and compact**

Wide 400 cm  
Pull-out 250 cm  
Weight 31,0 kg

**Housing White**  
Horizon Grey **447039**  
Price **1019,-**

**PW 1100 - A classic**

- Tension rod can be stowed away in front rail to save space
- Patented Easy Lock Flipper locks practical slide-out support legs in place
- Robust awning fabric made from one piece

**Perfect Wall 1100**  
Wide 260 cm  
Pull-out 250 cm  
Weight 21,0 kg

**Housing anthracite**  
Horizon Grey **447395**  
Price **659,-**



**Wall awning**  
Perfect Wall 1100



**Vehicle-specific adapter for Perfect Wall 1100 wall awning**

**Dethleffs Globebus**

Rail 4.00 m **438765 189,-**

**Rapido 2007/8/9**

4 plates à 2 x 16 cm & 2 x 8 cm **E2394 219,-**  
3 plates à 1 x 100 cm & 2 x 8 cm **E2852 229,-**

**Hymer Tramp, Hymermobile, Hobby Van, Hymer Exsis < 2007,**

Rail 3.50 m **438754 159,-**  
Rail 4.00 m **438755 229,-**  
Rail 5.50 m **438758 269,-**



# AWNING SEALING PROFILES AND TENSION RODS

## Sealing profiles for Wall awnings



**Thule sealing profile wide**  
suitable for wall awnings Thule Series 5 and 8.  
400 cm **432802 59,-**  
30 m **43295 330,-**



**Thule sealing profile narrow**  
suitable for wall awnings Thule Series 5 and 8.  
400 cm **432803 59,-**  
30 m **432951 330,-**

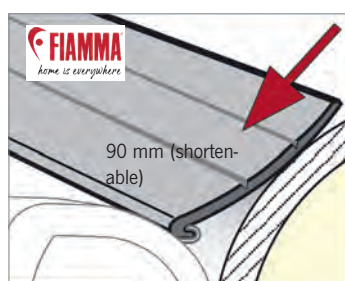

**Fiamma sealing profile RainGuard L**  
For Fiamma awnings mounted with adapters protruding up to 9 cm or on strongly curved walls.  
550 cm **434852 70,-**

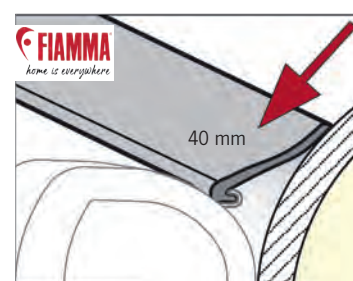

**Fiamma sealing profile RainGuard M**  
For Fiamma awnings mounted with adapters protruding up to 4 cm or on curved walls.  
550 cm **433831 61,90**

## Sealing profiles for roof awnings

for sealing between awning and vehicle, self-adhesive and closed-pore.

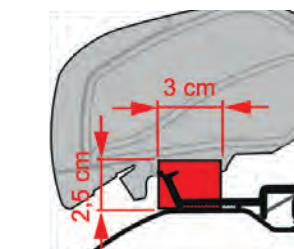

**FIAMMA**  
home is everywhere

**Fiamma foam sealing tape**  
Suitable for roof awnings Fiamma F80.

W 3.0 cm, H 2.5 cm. 450 cm  
**434851 46,80**

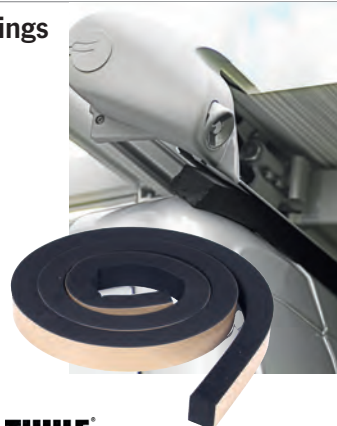

**Thule foam sealing tape**  
Suitable for Thule Omnistor 6300 roof awnings.

W 3.0 cm, H 2.5 cm. 2 x 200 cm  
**43292 55,-**

## Thule Tie rods round

to stabilize the Awning. Also suitable as a receptacle for side panels. Made of aluminum (spring loaded and lockable).



### Thule Tension Rafter G2 aluminum for side wall awnings

200 cm for TO 5200/5003	<b>432973</b>	<b>59,-</b>
250 cm for TO 5200/5003	<b>432974</b>	<b>61,-</b>
275 cm for TO 8000	<b>432975</b>	<b>69,-</b>

### for roof awnings

200 cm for TO 6200/6300	<b>432976</b>	<b>59,-</b>
250 cm for TO 6200/6300	<b>432977</b>	<b>61,-</b>
300 cm for TO 9200	<b>432978</b>	<b>73,-</b>

### for caravan awnings

250 cm for TO 1200	<b>432972</b>	<b>61,-</b>
--------------------	---------------	-------------

## Fiamma tension rods - Rafter / Rafter PRO

- Increases the rigidity of the awning Awning, better fabric tension
- For awnings up to 250 cm extension (adjustable from 142-265 cm)



**Rafter - straight tie rod**  
For F45 and F80

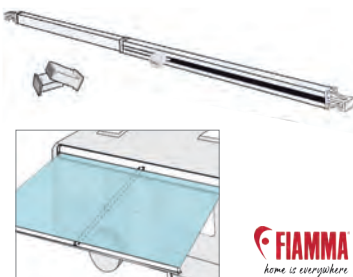

**434554 54,90**



**Rafter PRO - curved tension rod**  
Additionally improves water drainage. Attention: do not use in intense sunlight.  
For F45 and F80

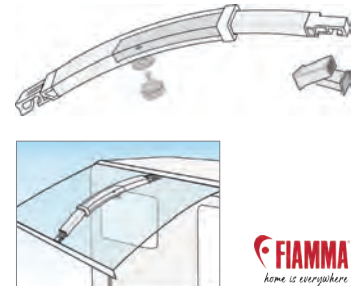

**43315 77,40**

### Adapter F65 for Rafter and Rafter PRO

For older awnings F65 adapter is necessary to mount the rafter.

**E4360 9,30**

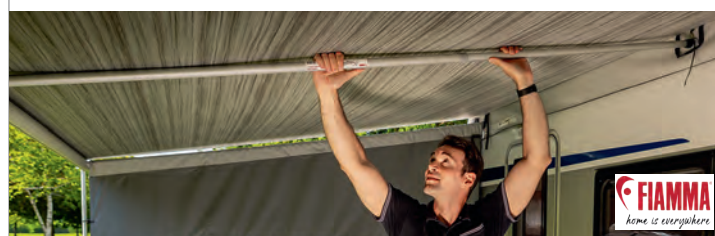

### Rafter for caravan gate

aluminum with twist lock with extension 225-250 cm  
**434553 41,90**

No drafts under the vehicle



**For motorhomes,**  
550 x 60 cm, to close wheel recess,  
can be shortened if necessary.  
Fastening with press studs.  
434381 113,40



**Fiat Ducato > YOC. 6/06,**  
497x45 cm. Fastening with magnets  
and rope tension. Suitable for all  
vehicle lengths up to 636 cm.  
434383 194,--



**Volkswagen Transporter 5/6/6.1,**  
250 x 42 cm. Attachment with mag-  
nets and cable tensioning.  
434382 130,--



Inflatable windbreak



Just put under the car  
and inflate. Supplied without pump.  
Material: HD PVC.  
L 250 cm, Ø 30 cm, approx. 3.2 kg.  
Pack size: approx. 45 x 14 x 12 cm.  
905991 129,--



Awning security

Signal storm band

Band is easily visible in the twilight.  
Suitable for awnings & tents for storm  
protection.

**Scope of delivery**two-piece strap,  
13 m, adjustable, 2 relief springs  
94832 21,95



Peggy Peg Fix&Go AntiFlap

This awning clamp reduces the  
annoying "flapping noise" almost com-  
pletely. Widely projecting awnings can  
be tightened even better with several  
AntiFlap's per side. Fix&Go AntiFlap  
is compatible with almost all awning  
systems, whether with round, oval or  
square rafter poles.

**Contents:** 2 Fix&Go AntiFlap, addi-  
tionally needed: 2 rafters of awning  
manufacturer.

94851 39,90



Peggy Peg TieStraps

For additional tensioning of awnings  
and bag awnings in bad weather to  
take strain off the folding arms.

Per piece 94846 13,50



Peggy Peg Fix&Go Bridge

The optional use of Fix&Go Bridge increases distance between the anchor  
plate and the floor by 2 cm. The bridge-like design allows water to flow largely  
unimpeded and dirt particles are simply flushed out. If required, Fix&Go  
Bridges can also be stacked inside each other and the ground clearance  
increased, of course also on fine sandy surfaces. Attention should be paid to  
the length of the Peggys used. Content: 2 Fix&Go Bridges.

94850 8,40



Fix&Go

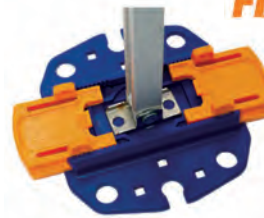

Peggy Peg Fix&Go  
Anchor Plate 2.0

Secure fixing of awning feet and tent  
poles, no sinking into soft ground or  
lifting off. The retraction of awnings  
is possible. For all screw pegs from  
Peggy Peg.

94828 14,--

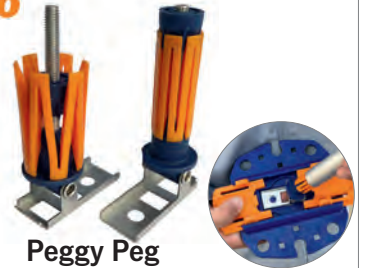

Peggy Peg  
Fix&Go adapter buffer

- Fixing of pole awnings, sun sails  
etc. with Ø 18-27 mm
- Secure fastening on almost all  
floors
- Fits perfectly with Anker plate 2.0
- Insert buffer at the end of the bar

94858 9,95

Fix&Go Tube - Flexible 10 l ballast tank

As an extension to the Fix&Go anchor plate  
for mounting on paving, concrete  
or asphalt. Fix&Go Tube is light  
and compact and becomes a  
10 kg additional weight.

Application: Adapter plug-in shoe  
onto the anchor plate. Hose  
fill with water and place in the basket  
then attach to the awning base with Velcro.

Attention: Fix&Go Tube does not replace an awning attachment to the ground!

**Fix&Go Tube, 1 piece** 94853 19,90

**Set of 2 Tube Pavilion:** Design like Fix&Go Tube, but without adapter shoe.  
Simply attach to the pavilion leg with Velcro. 948531 31,50



Anchor plate 6 pcs

Universal mounting plates  
**Scope of delivery** 2 anchor plates,  
2 storm hooks, 2 Uni plates

94831 19,--



Croc adapter set of 4

Insert into piping rail and can be  
used for hanging clothes hangers or  
other items. Together with Crocodile  
Peggy can also be attached a tensi-  
on belt. 4 pcs.

94845 7,50

Further windshields can be found on page 69



# AWNING AND TENT GUY ROPES

Belt width 4 cm

**REIMO TENT TECHNOLOGY**

① **Guy set**

- Storm band for awnings or awnings
- Complete set with pegs and tension spring
- Prevents the awning from billowing

Length: 11 m	432882	10,90
Length: 14 m	432881	14,90

② **Protective set, can be opened with Velcro set of 3**

	43541	7,90
--	-------	------

### Storm protection for Thule Omnistor awnings

**Hold Down Kit**

Prevents the awning from blowing up. Fastening between articulated arms and awning cloth. 11 m long black strap with pegs, fastening material and bag. For awnings up to 6 m wide.

432860	31,-
--------	------

**THULE Omnistor**

**Hold Down Side Strap Kit**

Attachment to the support legs. Also possible with awning awning. 2 straps, 3 m each, fixing material, pegs and bag. Not suitable for Thule Omnistor 2000.

432864	37,-
--------	------

**NEW**

**REIMO TENT TECHNOLOGY**

**Awning storm strap set**

- Ser secure fastening of the awning

Scope of delivery:  
 2x steel pegs 38cm  
 2x spring 10cm  
 2x nylon strap with plastic hooks 4.8m  
 2x triangular strap width piping 17.5cm

**Weight: app. 1kg**

432883	17,95
--------	-------

### Storm protection for Fiamma awnings

**LED WARNING SOLAR**

- Securing the storm bracing in the dark

**Scope of delivery:** 2 LED lights with integrated solar battery for attachment to awning tensioning straps. Also fits into the keder rail of caravans and motorhomes.

432863	39,20
--------	-------

**FIAMMA**  
home is everywhere

**Storm bracing TIE DOWN**

- Protects in wind
- Stretch over the joint arms of the awning and anchor in the ground
- Belt length 11 m - for awnings up to 6 m

Black	43286	25,50
Yellow	432861	25,50

**FIAMMA**  
home is everywhere

**Storm bracing TIE DOWN S**

- Secure attachment to the front panel of awnings F65, F45 + F35 and Caravan Store

**SOD:** 2 tensioning straps of 300 cm each, 2 ground pegs & 2 tensioning springs. Also fits into the keder rail of caravans and motorhomes.

F45/F65/F80 Black	432862	34,-
F45/F65/F80 Yellow	432865	34,-
Caravan Store	E4495	33,-

**Awning hanger**

**6 piece**

Ø 5+7 mm incl. S-hook, for pulling into the keder rail of the awning

901274



5,95

**Piping eyelets 5+7mm - 6 pieces**

The eyelets have 5 mm piping on one side and 7 mm piping on the other. This makes them suitable for caravans, motorhomes, awnings and can be used multifunctionally, e.g. as a holder for storm lines, solar showers, utensil bags, coat hooks, etc.

set of 6

901693

4,95



**Keder-Travel Adapter**

Suitable for attaching an awning to the front profile of the awning. Double keder Ø 5+8 mm

Length 3m

904493

31,50

Length 4m

904495

34,95

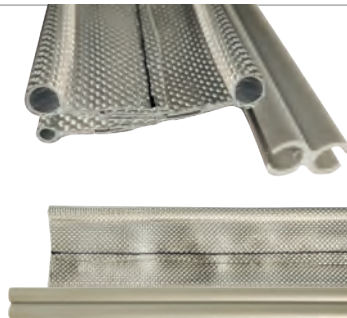

**Anti-flutter clamps for awnings, sun sails, tarpaulins, etc.**

- Easy to fix
- Also available as extra wide jumbo version
- Prevents fluttering noise
- Reduces damage

① 2 pieces with 1x short and long belt each

901276

12,95

② Clamp Jumbo 1 piece extra wide

901275

19,95



**Locking piece Keder rail - set of 2**

Prevents the keder from slipping out or shifting in the keder rail.

Ø 5 mm

901271

3,95

Ø 7 mm

901272

3,95

**Locking piece keder rail**

For keder strips with Ø 7mm, fixes your caravan awning, awning, sun awning or similar.

2 piece

901273

7,50



**FROLI anchor plates, 2 pieces**

- Securing tents, awnings, marquees, etc.
- Test load 200kg
- Made in Germany

2 anchor plates to secure tent, awning, Awnings & much more. Simply use the incl. screws in the floor. Available are additional points for attaching, e.g., dog leashes, boats & other camping accessories.

2 anchor plates (Ø140mm), 10 fixing screws (8x180mm)

94859

20,95



Roof rack sets by THULE can be found on page 622 + 623

**① Railing for Thule Omnistor 6300**

- Mounting without drilling
- Load capacity 100 kg

Suitable for: Fiat Ducato, Peugeot Boxer, Citroën Jumper > 6/2006.

Roof rails / carrier incl. awning mounting adapter For long wheelbase 403 cm (599 cm vehicle length) and standard high roof H2. Consisting of 2 x 3 support legs, 4 cross members.

For Ducato ≥ 2007

42155

1019,-

**② Railing**

for Thule Omnistor 5003/5200

- Aerodynamic shape
- No drilling work necessary
- Optional crossbars in any number

Suitable for: Fiat Ducato, Peugeot Boxer, Citroën Jumper > 6/2006

**Roof rails/carrier STYLE**

Aluminum.

for wheelbase 403 cm

42151

1355,-

for wheelbase 345 cm

42152

1355,-



**③ Cross member, 2 pieces**

100 kg payload/crossbeam pair, 200 kg max. payload.

421521

195,50

④ Awning mounting adapter for mounting a Thule Omnistor 5 series wall awning

421522

119,-





**Rafter LED - Awning tensioning rod w/ LED**

- With COB LEDs. Neutral light 4000 K, 13.5 watts
- Power supply via adapter cable with cigarette lighter plug
- For awnings up to 250 cm extension (adjustable from 142-265 cm)

Rafter LED for F45, F80s and F65	440685	111,-
Rafter LED CS for caravan gate	440686	111,-



**Rafter LED - Tension rod with LED**

- Neutral light thanks to COB LEDs w/ 4000 K.
- Increases the tension between the two awning arms
- Prevents the formation of water pockets
- Incl. Connection cable for cigarette lighter

Rafter LED Van for F40van (270 cm), F43 (270 cm) and F45s (260 cm).	440687	115,-
13.5 W, weight approx. 1.35 kg		



**LED lighting comfort w/ or without motion sensor**

- 12 Volt LED Outdoor Light Cold White
- Mounting under the awning housing, also suitable for other applications (e.g. as door light, garage)
- With 31 LEDs

For lighting the outdoor area and garage. The average lighting time of an LED is 25,000 hours. Super Bright LED with ø 5 mm. Light tone 7000 ° K, 3.1 watts, cable length about 1.2 m.

**Without motion sensor**, Weight 0,4 kg **43532** **62,70**

**With motion sensor**, Light duration 60 sec., only lights up in the dark when someone approaches. Weight 0,5 kg **435325** **92,-**



**LED case for F70, F45S and F45L**

Lighting set w/ 180 LEDs to be pulled into bottom groove of awning housing of F70, F45S or F45L. Basic set is for awnings w/ a width of 300 cm. The individual light elements can be connected by pressing them together. The basic set can be extended as required with the extension sets.

LED basic set 250 cm	435980	156,-
LED Erweiterungsset 50 cm	435990	38,20
LED Awning Case Deep Black	435100	156,-



**Lighting on front profile**

- 12 Volt LED Awning Lighting
- 2 lights with 10 LED each
- Including 5 m connection cable
- Snaps into the front panel
- 2.4 watts, 0.2 amps

43461	42,50
-------	-------



**Kit LED Strip**

- 12V COB LED strip, 4000 K
- Flexible LED strips for gluing under the awning housing.

**For Fiamma F43:**  
Length: 250 cm. 27.5 W. 0.5 kg  
**440684** **102,30**

**For Fiamma F80:**  
Length: 500 cm. 55.0 W. 0.5 kg  
**440683** **104,60**

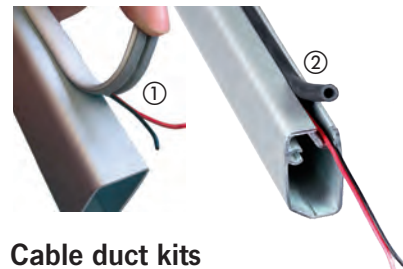

**Cable duct kits**

① **Kit Cables Rail:** two flexible rails. Ideal for folding arm awnings without a cable holder. Dimensions per rail: 13x3x1225 mm.  
**434612** **21,10**

② **Kit Cables Guide:** two flexible profiles for fixing cables for awnings with cable holders. Dimensions per profile: 1225 mm, ø 6.5 mm.  
**434600** **13,10**



①

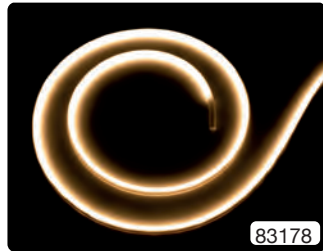

83178



②

① Awning lighting

- Suitable for outdoor use
- Dimmable with dimmer (831003)
- Self-adhesive with M3 adhesive tape

**LED Strip White** 780 Lumen/m  
120 LEDs /m, 12 V, 9.6 W/m. Dimmable. IP 67.  
Strip width 10 mm. Can be shortened every  
25 mm. Warm white 3000K.  
500 cm **83170** **69,90**

**LED strip white** 390 lumen/m  
60 LEDs /m, 12 V, 4.8 W/m. Dimmable. IP  
67. Strip width 7 mm. Shortenable every 50 mm.  
Warm white 3000K.  
500 cm **83171** **44,90**

**LED Strip White** 195 Lumen/m  
30 LEDs /m, 12 V, 2.4 W/m. Dimmable. IP 66.  
Strip width 7 mm. Can be shortened every  
100 mm. Warm white 3000K.  
500 cm **83174** **24,90**

**LED strip white** 620 lumen/m  
150 LEDs /m, 12 V, 10.8 W/m. Dimmable. IP 67.  
Strip width 10.5 mm. Self-adhesive.  
Warm white 3000K.  
500 cm **83178** **89,90**

② Radio remote control with dimmer

Remote control as a keychain.  
Functions: ON / OFF / Brighter / Darker. Switching  
capacity 96 W, quiescent current app. 30 mA.  
Housing dimensions: L90 x W60 x H37 mm.  
**831003** **19,90**

Awning light with 14 LEDs

12/24 volt DC 2.5 watt with plastic clamp,  
easily attaches to tent or awning poles. 5 meter  
cable and safety universal plug 2 A, fits DIN  
and cigarette lighter sockets. LED light does not  
attract insects.

**81191** **125,-**



Self-adhesive LED flex tape

**THULE** Omnistor  
Suitable for outdoor use. Can be shortened every 5 cm. Flexible, with self-ad-  
hesive 3M tape. 1 m connection cable. 60 Power LEDs/m w/ 340 to 380  
mA/m. 12 volt. Waterproof IP66.

<b>4 m length</b>	<b>433001</b>	<b>99,-</b>
<b>5 m length</b>	<b>43300</b>	<b>130,-</b>
<b>6 m length</b>	<b>433002</b>	<b>150,-</b>

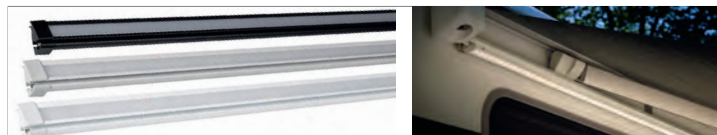

Tent and LED Mounting rail for TO 5200

for mounting under the awning. With keder rail for attaching tent EasyLink or  
QuickFit & mounting place for LED light strips.

300 cm, White	<b>43149</b>	<b>124,-</b>	400 cm, White	<b>431495</b>	<b>134,-</b>
300 cm, silver	<b>431490</b>	<b>124,-</b>	400 cm, silver	<b>431496</b>	<b>134,-</b>
300 cm, Black	<b>431491</b>	<b>124,-</b>	400 cm, Black	<b>431497</b>	<b>134,-</b>
350 cm, White	<b>431492</b>	<b>124,-</b>	450 cm, White	<b>431498</b>	<b>139,-</b>
350 cm, silver	<b>431493</b>	<b>124,-</b>	450 cm, silver	<b>431499</b>	<b>139,-</b>
350 cm, Black	<b>431494</b>	<b>124,-</b>			



You can find more  
LED strips in the  
Electrical area

LED flex ribbon, side emitting

**THULE** Omnistor  
Special LED tape for above LED mounting rail. Side emitting, self-adhesive.  
Length 400 cm

**43890** **130,-**



LED mounting rails for Thule roof awnings

For mounting under the awning. Combines the mounting option of awnings  
with the simultaneous use of LED lighting. Without LEDs.

Set for TO 6200/6300 3 x 130 cm, anthracite. o. Fig. **43889** **64,-**