





# Tents for caravans



## Sun sails



**PALM BEACH / PALM BEACH QUICK**  
Page 8 - 9



**Como size 1 - 10**  
Page 10



**MAURITIUS**  
Page 10



**Playa Air 300/400 & Playa 325**  
Page 11

## Adria Action awnings



**Adria Action Air 391 & 361 air tent**  
Page 12



**Adria Action Air 391 sun sail**  
Page 12



**One Beam Air - 220, 260 & 325**  
Page 13



**Rimini Air 2 - 390**  
Page 14

## Inflatable partial caravan tents

## Inflatable partial caravan tents



**MARINA AIR -290, 390 & 490**  
Page 15



**Sportlite Air 320**  
Page 16



**Evora 260 and 390**  
Page 7



**TAVIRA AIR 390, 490 & 590**  
Page 17

## Classic caravan awnings



**Palermo - Gr. 9 - 19**  
Page 18 - 20



**Bologna 400**  
Page 21

## All-season caravan awnings



**CASA ROYAL 2 - 320 & 390**  
Page 22

## Caravan protection



**Caravan protection and accessories**  
Page 23 - 27



**Thermal mats**  
Page 27





# PALM BEACH



Picture show PALM BEACH

**Sun roof**  
149,-



① **Side wall**  
99,-

## PALM BEACH/PALM BEACH QUICK practical sun canopies

- Domed roof against water pockets
- Roof with 2 diagonal fiberglass poles
- Spacious feeling
- Double piping Ø 5+7mm and tunnel

Chic and robust sun sail for your caravan or camping bus with sown on piping profile (Ø 5+7mm). The two diagonal fiberglass poles ensure a stable upward arch of the sun canopy. This stops water from building on the domed roof and makes for a spacious feeling and comfortable standing height.

## PALM BEACH - sun canopy

- Small packaging size
- Pockets with velcro in the corners for easy insertion of the fiberglass poles
- Color: Light grey/anthracite/lime

## PALM BEACH 2 - 2.6

Width 260cm

**Scope of delivery:** Sun canopy, 2 fiberglass poles, 2 rods, pegs, guy ropes & bag.  
900151 149,-

## PALM BEACH 2 - 3.0

Width 300cm

**Scope of delivery:** Sun canopy, 2 fiberglass poles, 3 rods, pegs, guy ropes & bag  
900152 169,-

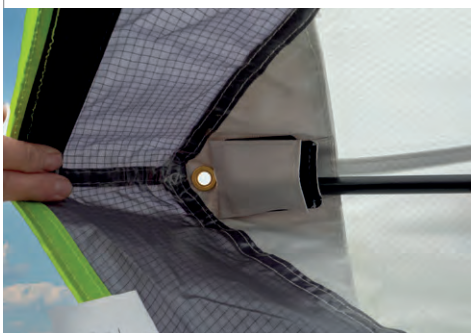

Bag for fiberglass poles



## Spare fiberglass poles (2 pieces)

for PALM BEACH 2 - 2.6 (900151)  
900148 19,95  
PALM BEACH 2 - 3.0 (900152)  
9001481 19,95





# PALM BEACH QUICK



Photo shows PALM BEACH QUICK

## PALM BEACH QUICK - Sun canopy

- With quick assemble-system
- Open with only one handle
- Fixed fiberglass poles
- Color: Light grey/anthracite

## PALM BEACH QUICK 2.6

Width 260cm

Scope of delivery: Sun canopy incl. 2 fiberglass poles, 2 rods, pegs, guy ropes and bag  
**900159** **159,-**

## PALM BEACH QUICK 3.0

Width 300cm

Scope of delivery: Sun canopy incl. 2 fiberglass poles, 3 rods, pegs, guy ropes and bag.  
**900169** **179,-**

## PALM BEACH - Side walls

- For all PALM BEACH - sun canopies
- Window with mosquito net and cover inside
- Easy attachment to the roof with velcro
- Mountable on both sides

### ① PALM BEACH - Side wall

narrow width to ensure unobstructed opening of the sliding door - B 225 x H 180cm, weight: ca. 2.2kg  
**900153** **99,-**

### ② PALM BEACH SPACE - Side wall

Height of 200cm ensures further set-up for more space under the sun canopy. W 240 x H 200cm, weight: ca. 2.2kg  
**900154** **109,-**



Model	Dimensions	ca.	ca.	Art. no.	Price
PALM BEACH 2 - 2.6	W 260 x D 240cm	Ø16 x 74 cm	5,5 kg	900151	149,-
PALM BEACH 2 - 3.0	W 300 x D 240cm	Ø18 x 74 cm	6.8kg	900152	169,-
PALM BEACH QUICK 2.6	W 260 x D 240cm	Ø11x 186 cm	5,5 kg	900159	159,-
PALM BEACH QUICK 3.0	W 300 x D 240cm	Ø11 x 202 cm	6.8kg	900169	179,-





**REIMO TENT**  
TECHNOLOGY

from **79,90**

Size 8 light grey



Extremely tear-resistant and weatherproof

Size 4 anthracite

## COMO - the universal sun sail

- Extremely tear-resistant
- Weatherproof and washable
- With 5+8mm piping connection

Very sturdy sun sail made of Oxford polyester 210D for sizes 1 - 3, from size 4 30D in light grey or anthracite with grey edging.

Scope of delivery: Sun sail, rods, pegs, guy ropes.

### Light grey - depth 240cm

Size	Width cm	Piping length cm	Eye-lets	ca.	Art. no.	Price
1	200	206	2	2,5 kg	90020	79,90
2	250	256	2	3,0 kg	90021	89,90
3	300	306	3	3,5 kg	90022	99,90
4	350	356	3	4,0 kg	90023	109,90
5	400	406	3	4,5 kg	90024	129,-
6	450	456	3	5,0 kg	90025	139,-
7	500	506	3	5,5 kg	90026	159,-
8	700	708	5	7,5 kg	90019	159,-
10	900	908	6	8,5 kg	90017	189,-

### Anthracite - depth 240cm

2	250	256	2	3,0	900212	89,90
---	-----	-----	---	-----	--------	-------

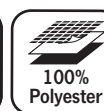

Tensionable, pivoting side panels

from **131,-**



## MAURITIUS - sun sail with higher flexibility for caravans

- Shade for large and small vehicles
- Loops for fastening with suction cups and piping Ø 5 + 8mm

The downward-tilting side sections provide additional light or privacy protection. Material 300D RipStop polyester. Light grey color.

Scope of delivery: Sun sail, height adjustable rods to max. 220cm: 2pcs. for MAURITIUS M and L, 3pcs. for MAURITIUS XXL. 6 pegs, 6 guy ropes in a practical bag.

① MAURITIUS M	900575	131,-
② MAURITIUS L	900573	139,-
③ MAURITIUS XXL	900572	159,-

## RE-TENT the new collection

from Reimo TentTechnology to



protect our nature. The tent fabrics are made from recycled disposable plastic bottles. Each m<sup>2</sup> is equivalent to ca. 3 x 5l plastic cola bottles or 9 x 550ml plastic water bottles.

The tried and tested MAURITIUS is available in 3 sizes in the RE-TENT collection. All properties see left. New material 300D recycled Oxford polyester. Color grey.

① MAURITIUS 460 (RE-TENT collection)	900576	139,-
② MAURITIUS 510 (RE-TENT collection)	900577	159,-
③ MAURITIUS 560 (RE-TENT collection)	900578	169,-

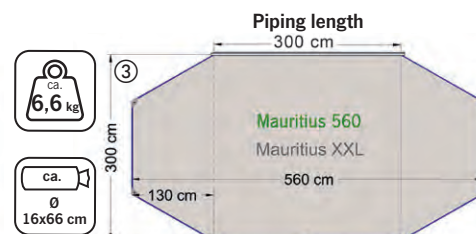
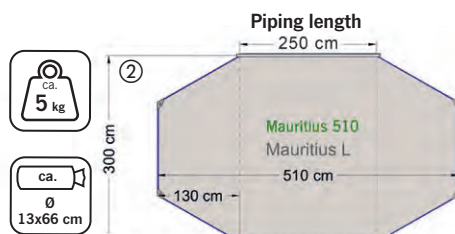
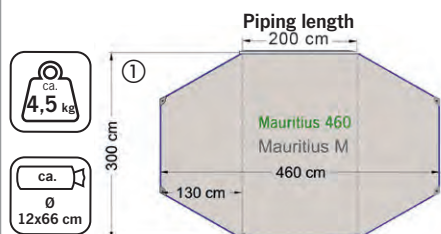





## PLAYA AIR 300 & 400 CARAVAN

### Universal air sun sail

Mounting height: 235 - 250 cm

- Sun sail with air technology
- Quick assembly and dismantling
- Light
- Side panels can be removed with a zipper
- Storm bracing with click lock
- Set-up with just one air tube
- Connection w/ piping profile Ø +7mm

Scope of delivery: Awning, air tube, 2 side walls, air pump, ground pegs, storm bracing, guy ropes, bag.

Width	Piping length	Art. no.	Price
300 cm	306 cm	906887	339,-
400 cm	405 cm	906888	379,-

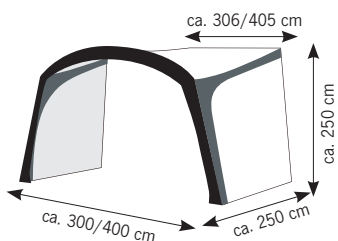

Piping Ø 7 mm	150D Oxford Polyester	UV-Protection 50+	2.000 mm
Flame retardant	Airtube	ca. 7,0 kg/7,5 kg	ca. 77x Ø 17 cm



Side walls can be easily removed with zipper



## PLAYA CARAVAN 325

### universal sun sail

Mounting height: 235 - 250 cm

- Universal sun sail
- With large side windows
- Quick assembly and dismantling
- Light
- Assembly with only one fiberglass pole
- Connection with Ø 7mm piping profile

Scope of delivery: Sun sail, fiberglass and steel poles, ground pegs, guy ropes, carrying bag.

Width	Piping length	Art. no.	Price
325 cm	335 cm	906882	159,-



Piping Ø 7 mm	185T, 68D Polyester	UV-Protection 50+	1.000 mm
Flame retardant	Fiberglass + Steel	ca. 6 kg	ca. 77x Ø 17 cm

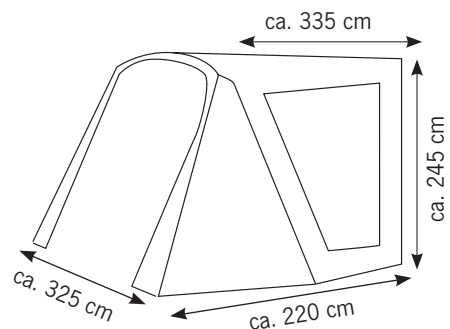





from 599,-



Only for left-hand drive !

Front completely removable

**ADRIA ACTION AIR 391**  
**Air sun sail**

- Front and side walls completely removable, can also be used as awning
- Mosquito net front available separately

Specifically developed for caravan ADRIA ACTION 391. (not suitable for Adria Action Sport) 1 TPU air tube for faster assembly. The front wall with door and side walls each have 1 large, transparent window and are completely removable.

**Scope of delivery:** Tent, air tube, air pump, 3 roof poles (aluminum), storm bracing, guy ropes, pegs, bag. **936689 599,-**

**Optional accessories:**

① Mosquito net front **936690 49,99**

**Fitting awning carpent (see photos):**

Villa Stripe grey 2.5 x 4.5m, PP, incl.bag **905172 79,95**

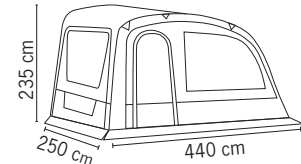

① Mosquito net front



Storm bracing included



Piping 07 mm	210D Oxford Polyester	Ripstop Polyester 190T	UV-Protection 50+	3.000 mm	Flame retardant	1x Airtube	ca. 14 kg	ca. 75x 45 x 35 cm
--------------	-----------------------	------------------------	-------------------	----------	-----------------	------------	-----------	--------------------



from 749,-



Only for left-hand drive !

Incl. tent floor and wheel/wind screen

**ADRIA ACTION AIR**  
**inflatable awnings**  
**for Adria Action 361 and 391**  
**(not suitable for Adria Action Sport)**

- Quick and easy to assemble
- Windows with mosquito nets
- Front door can also be used as sun sail
- Removable floor included
- Wind screen against drafts

Fits perfectly with the curve of the outer wall. Side windows are equipped with mosquito nets and roll-up covers. The front, with 2/3 transparent PVC window and 1/3 mosquito net, can be rolled up or used as a sun sail. The removable floor is included.

**Scope of delivery:** Tent skin, 1 TPU air tube, 3 roof reinforcement poles, 2 rods, tent floor, wind skirt, guy ropes, steel pegs, air pump, bag.

**Adria Action Air 361 936680 749,-**

**Adria Action Air 391 936688 799,-**

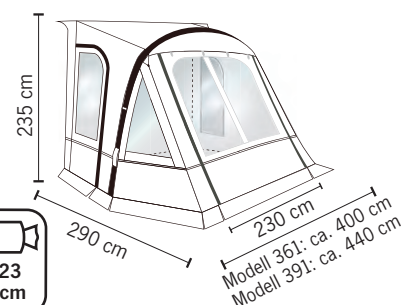

side windows with mosquito nets

Piping 07 mm	Polyester 190T	UV protection	3.000 mm	Flame retardant	Seams sealed	1x Airtube	ca. 1,5 kg	ca. 80x 23 x 25 cm
--------------	----------------	---------------	----------	-----------------	--------------	------------	------------	--------------------





# ONE BEAM AIR



Front with mosquito net

from 299,-

ONE BEAM AIR 325

Mounting height: 235 - 250 cm

ONE BEAM AIR 220, 260, 325 Fast assembly with mosquito net front

- With only one air tube for fast assembly and dismantling
- Front and sides with mosquito net for ventilation and protection against insects
- Lightweight
- Wind screen, pressure poles and storm bracing included

Inflatable caravan awning with only 1 air tube (TPU Ø 10cm) for fast assembly and dismantling. Both side doors & the large front door are equipped w/ mosquito nets & transparent windows.

Scope of delivery: Tent with air tube, pegs, 2 rods, 2 pressure poles, wind screen, guy ropes, storm bracing, air pump, bag. Width 325: 1 roof reinforcement (TPU).

Width	Piping length	Art. no.	Price
220 cm	253 cm	935397	299,-
260 cm	292 cm	935398	339,-
325 cm*	364 cm	935399	429,-

\* (with additional air tube for roof reinforcement)



Storm bracing



Only one air tube for fast assembly

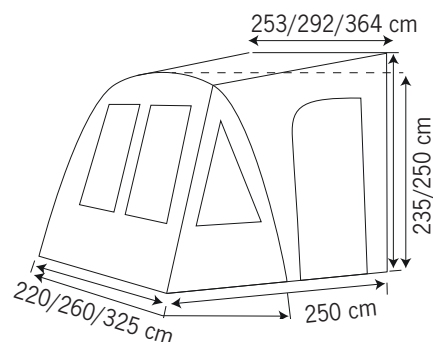

Replacement air tube:

For width 220	9353971	59,95
For width 260	9353981	64,95
For width 325	E26607	79,95

Roof reinforcement (air tube) for width 325	E26608	34,95
---	--------	-------



Piping Ø7mm



100% Polyester 185T



3.000 mm



Flame retardant



UV protection



Airtube



ca. 115 x 25 x 30 cm



ca. 11 kg Width 220



ca. 12 kg Width 260



ca. 13 kg Width 325





# RIMINI AIR 2 - 390



from **639,-**



Mounting height: 235 - 250 cm

## RIMINI AIR 2 - 390 Quick assembly air tent

- Premium TPU air tubes
- Easy to set up thanks to 4 separate air tubes
- Transparent windows
- The front parts can be rolled up or used as sun sails
- Particularly stable thanks to combination of air columns and aluminum reinforcement rods
- Including wind screen, pressure rods and foam bulge

The tent is particularly durable due to replaceable double air tubes. The front consists of 3 segments with large transparent windows.

The side sections are equipped with mosquito nets for good ventilation.

All windows have an interior cover to protect privacy.

Color: light grey and dark grey

**Scope of delivery:** Tent skin incl. air tubes, air pump, pitching poles, pressure poles, foam bead reinforcement poles, wind flap, guy ropes, pegs, stuff sack



**Including:** Foam bulge and rods for secure attachment to the caravan

**Attachment to the vehicle:**

- Double piping  $\varnothing$  5+7 mm

Polyester 185T

4x TPU Airtubes

PU-coated

3.000 mm

ca. 17 kg

ca. 75 x 35 x 30 cm

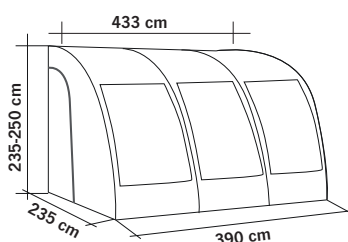

RIMINI AIR 2 - 390 piping length 433cm  
900034 639,-

Optional accessories:

Tent floor 9000342 44,95

Inner tent, 230 x 130cm 9000341 52,50

Spare air tube 9000343 59,95





# MARINA AIR



from **649,-**

Mounting height: 235 - 250 cm

### MARINA AIR 290, 390, 490 Easily mounted premium air awning

- Both side walls with doors & mosquito net
- Including mosquito net windows in the front
- All front sections can be removed or used as sun sails
- Window with porch function
- Interior window covers
- Incl. Foam padding with pressure rods
- Including wind screen for attachment to caravan

Awning for caravans with air technology. All the windows can be opened, then you almost sit like on an airy porch. Foam bulge with steel rod for pressing onto the caravan. Floor as a "frame" under air tubes for quick assembly.

**Scope of delivery:** Air tubes, mosquito net windows, wind screen, tension poles, pegs, guy ropes, air pump, bag, rods, foam padding and pressure rods.



Foam padding and pressure bar



Including mosquito net panels



Storm bracing



#### Replacement air tubes:

Outside (left+right)	E26606	49,95
Center	E26605	49,95

You can find suitable awning carpets from page 114

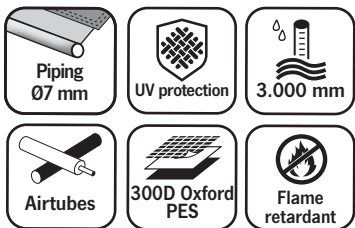

Model	ca.	ca.	Art. no.	Price
<b>MARINA AIR 290</b> 2 segments and 3 air tubes	20 kg	70 x 44 x 40 cm	93702	649,-
<b>MARINA AIR 390</b> 3 segments and 4 air tubes	24 kg	78 x 45 x 44 cm	93703	799,-
<b>MARINA AIR 490</b> 4 segments and 5 air tubes	28 kg	78 x 55 x 50 cm	93704	899,-

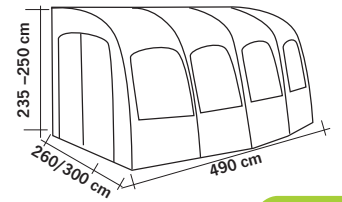
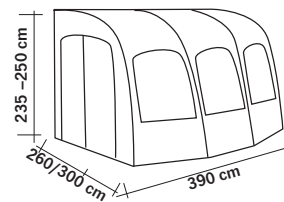
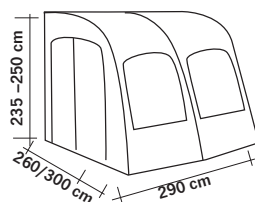



# INFLATABLE CARAVAN PARTIAL TENTS



Mounting height:  
250 - 265 cm



## Sportlite Air 320

- Also suitable for motorhomes
- Spacious living area with extension option (optionally available)
- 280 HDE fabric: high-density, weatherproof, lightweight
- Dynamic, intelligent pressure relief valve system
- Single inflation (single inflation point)
- Front panels can be zipped off
- Zip off left and right side doors with mesh inserts
- Transparent PVC windows
- Adjustable webbing tensioning system

Lightweight caravan/motorhome air awning.

The new Single Inflation Technology makes it possible to connect sections of the air frame and then isolate them with airlock valves. This ground-breaking system offers absolute ease by in- and deflation and gives you peace of mind that every part of the structure can be isolated from the other parts of the air frame.

**Scope of delivery:** Tent with air tubes, pump, wind screen, pegs, guy ropes, storm bracing and carry bag.

**Sportlite Air 320**      900055      1130,--

**Optional accessories:**

Extension L 225 x H 180cm	900056	399,--
Inner tent	900029	119,--
Ventilated ceiling	900057	48,95
Pressure rods (2pcs.)	9000062	30,--

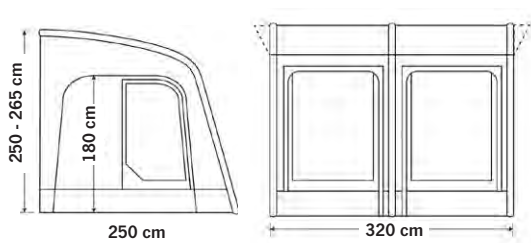

Optionally ventilated ceiling

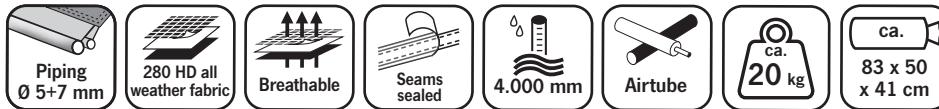

Mounting height:  
235 - 250 cm



## Evora 260 and 390 - Pro Climate for warmer regions, as it is particularly breathable

- Pro Climate synthetic material: Breathability like polycotton & water resistance/durability of polyester
- Dura-Tech frame - Single point inflation system
- Tinted windows, doors with zipper
- With sliding curtains for more privacy
- With sturdy storm bracing

Ideal awnings for smaller families who need extra sleeping or living space. Through the "Dura-Tech" single-point inflation system, this air awning is one of the fastest and most efficient on the market, without complicated connection tubes. Color: Graphite/steel blue **Scope of delivery:** Tent w/ air tube, air pump, curtains, wind screen, storm bracing, pegs.

**Evora 260**      900009      739,--

**Evora 390**      9000092      899,--

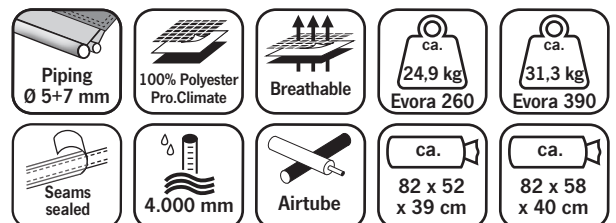
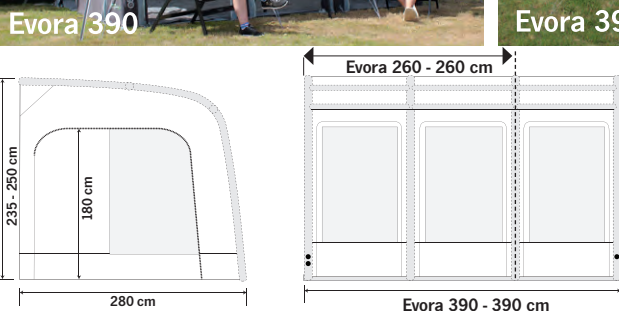



# TAVIRA AIR



Mounting height: 235 - 250 cm



### TAVIRA AIR 390, 490, 590

- One-point inflation system
- Additional roof reinforcements
- High-quality TPU air tubes
- Suitable for all-year use
- Top ventilation with external cover
- Large transparent front window with inner covers
- Doors on both sides
- Side walls with large mosquito net windows with outer cover
- Incl. Foam bulge and pressure rods

**Scope of delivery:** Tent skin, Single-Point inflation - air tubes (TPU), 3 roof reinforcement tubes (TPU), wind screen, guy ropes, pegs, air pump, bag, foam padding and pressure rods.



Model	ca.	ca.	Piping length	Art. no.	Price
<b>TAVIRA AIR 390</b> Front with 3 windows	26 kg	80 x 50 x 40 cm	438 cm	93826	999,-
<b>TAVIRA AIR 490</b> Front with 3 windows	27 kg	80 x 50 x 45 cm	538 cm	93827	1149,-
<b>TAVIRA AIR 590</b> Front with 4 windows	28 kg	80 x 50 x 50 cm	638 cm	93828	1399,-

- Optional accessories:**
- Inner tent (200 x 140cm) 938262 69,95
  - Tent floor TAVIRA AIR 390 938261 49,95
  - Tent floor TAVIRA AIR 490 938271 59,95
  - Tent floor TAVIRA AIR 590 938281 69,95

Spare tubes available on [www.reimo.com](http://www.reimo.com)

**Attachment to the vehicle:**

- Piping Ø 7 mm

300D Oxford Ripstop Polyester

UV protection

Flame retardant

3.000 mm

1 x Airtube

Seams sealed

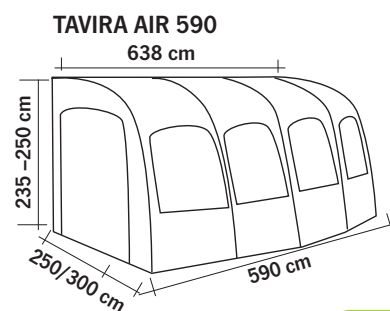
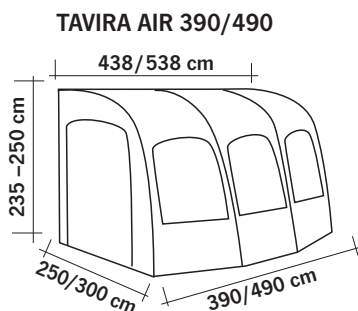





# PALERMO



Photo shows size 12



## PALERMO

### classis caravan awning

With circumferential dimension and 300cm depth

- Suitable as all-year tent
- Depth 300cm for spacious interior
- Canopy (30cm)
- Weather resistant
- Lightweight aluminum poles or traditional steel poles optional
- With quick-clamping device
- Front window with porch function
- Large transparent windows with outer covers
- Both halves of front wall can be taken out separately
- Side panels with window + door
- All windows with curtains for a cozy ambience and privacy
- Mosquito net inserts in side windows
- Roof interior with design for a more comfortable atmosphere
- High ventilation under canopy
- High-quality YKK zippers
- Additional tensioning options under the windows and roof

#### Material:

Roof: Coated polyester fabric (280g/m)

Walls: Coated polyester fabric (230g/m)

Dirt strips: PVC (1-ply)

Frame: Aluminum or steel Ø 25/28mm

Color: Light grey/grey/anthracite

**Scope of delivery:** Tent skin, poles (aluminum or steel), porch rods, wind screen, curtains, storm bracing, guy ropes, pegs, 2 bags

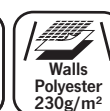





Circumferential dimension	Size	ca. Alu	ca. Steel	Poles in delivery	Aluminum poles Art. no.	Price	Steel poles Art. no.	Price
850-875 cm	9	32,5 kg	38 kg	3 roof poles, 3 vertical supports	–	–	9363861	899,--
876-900 cm	10	33 kg	39 kg	3 roof poles, 3 vertical supports	9363842	1099,--	9363862	949,--
901-925 cm	11	38 kg	45 kg	5 roof poles, 3 vertical supports	9363843	1199,--	9363863	999,--
926-950 cm	12	39,5 kg	46 kg	5 roof poles, 3 vertical supports	9363844	1249,--	9363864	1049,--
951-975 cm	13	40,5 kg	47 kg	5 roof poles, 3 vertical supports	9363845	1299,--	9363865	1099,--
976-1000 cm	14	42,5 kg	50 kg	5 roof poles, 5 vertical supports	9363846	1349,--	9363866	1149,--
1001-1025 cm	15	43,5 kg	51 kg	5 roof poles, 5 vertical supports	9363847	1399,--	9363867	1199,--
1026-1050 cm	16	44 kg	52 kg	5 roof poles, 5 vertical supports	9363848	1449,--	9363868	1249,--
1051-1075 cm	17	–	54 kg	5 roof poles, 5 vertical supports	–	–	9363869	1299,--
1076-1100 cm	18	–	55 kg	5 roof poles, 5 vertical supports	–	–	9363870	1349,--
1101-1125 cm	19	–	56 kg	5 roof poles, 5 vertical supports	–	–	9363871	1399,--

Packaging dims. ca.

Size 9-10: Tent: 115 x 30 x 30cm Poles: 115 x 27 x 16cm

Size 11-13: Tent: 115 x 30 x 32cm Poles 115 x 27 18cm

Size 14-19: Tent: 115 x 30 x 35cm Poles 115 x 27 x 20cm

**Optional accessories:**  
can be found on the next page  
Awning carpets available from page 114





### ① Sun canopy PALERMO

- Easy attachment to awning with piping (included in scope of delivery)

Depth: 240cm, material: polyester 280g/m

Scope of delivery: Sun canopy, piping, rods, guy ropes, pegs, bag

(Attention: only suitable for PALERMO mit steel poles)

for size 9	9363883	229,-
for size 10	9363884	229,-
for size 11	9363885	249,-
for size 12	9363886	259,-
for size 13	9363887	269,-
for size 14	9363888	279,-
for size 15	9363889	279,-
for size 16	9363890	289,-
for size 17	9363891	299,-
for size 18	9363892	309,-
for size 19	9363893	319,-

### ② Side wall for sun canopy PALERMO

- Fits all sizes
- Easy attachment to canopy with piping (included in scope of delivery)

- Fits right and left
- With large window
- Depth 240 cm

• Material: Polyester 210 g/m<sup>2</sup> Scope of delivery: Side wall, rods, guy ropes, pegs, bag

9363894	79,95
---------	-------

### ③ Inner roof PALERMO

- Easy attachment to canopy with hooks
- Homelike atmosphere
- Reduces condensation build-up
- Material: Poly-cotton

for size 9	9363872	59,95
for size 10	9363873	62,95
for size 11	9363874	64,95
for size 12	9363875	67,95
for size 13	9363876	69,95
for size 14	9363877	72,95
for size 15	9363878	74,95
for size 16	9363879	77,95
for size 17	9363880	79,95
for size 18	9363881	82,95
for size 19	9363882	84,95



### How to measure the circumference

If you do not know the overall dims. of your caravan, you have three options for determining them:

- Look in the brochure or in the technical data supplied w/ your caravan
- Contact your caravan manufacturer and enquire about your overall dimensions, stating model and YOC
- Measure yourself - the safest method. Caravan should be positioned horizontally on a level surface in order to measure overall dimensions of your caravan. You measure from guy point A (floor) through the piping rail of the caravan with a non-stretchable cord to guy point B (floor). If the piping rail still has an inward curve at the lower end, you must measure perpendicular to the floor or remove the cord from the rail at the insertion point.

#### Important for aerodynamic caravans:

For caravans with an extremely slanted bow, you must already measure perpendicular to the floor from a height of ca. 185cm (you are not following the rail anymore).

This determined value is the circumferential dimension. Points A and B are also the guy points of your awning. If the overall dimensions of your caravan are on the edge of the awning size specifications, you should opt for the smaller tent size. The size of your caravan awning depends solely on the circumferential dimension. Only the depth of the tent is a free choice.

#### Attaching the roof poles to the caravan.

- With wall eyelets, firmly screwed (seal drill holes well)! We recommend this option for partial tents. The rear corners of the roof are fixed and do not move, even in strong crosswinds. Wall eyelets are also a good choice for permanent camping.
- With screwless Vario clips! These are pushed onto the inner piping. The advantage of this version is the flexibility in the choice of fixing points. Clip is connected to tent roof and cannot fall down if the pressure on the poles decreases.

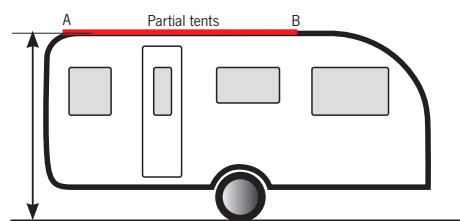
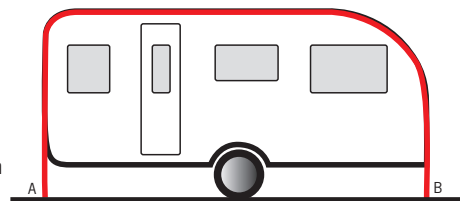





## BOLOGNA 400



Mounting height:  
235 - 250 cm



## BOLOGNA 400 caravan partial tent

- Suitable as all-year tent
- Canopy (30cm)
- Weather resistant
- Sturdy steel frame with quick-release device
- Front window with porch function
- Large transparent windows with curtains and external cover
- Side panels with window + door
- Front and side walls completely removable
- All windows with curtains for a cozy ambience and privacy
- Mosquito net inserts in side windows
- Roof interior with design for a more comfortable atmosphere
- High ventilation under canopy
- High-quality YKK zippers
- 3 roof poles and 3 vertical supports
- Tensioning options under the windows and on the roof

## Material:

Roof: coated polyester fabric (280g/m<sup>2</sup>)

Walls: coated polyester fabric (230g/m<sup>2</sup>)

Dirt strips: PVC (1-ply)

Frame: steel tubes Ø 22/25mm

Color: Light grey/grey/antracite

Dimensions: W 400 x D 240 x H 235-250 cm

Weight: 34 kg

## Scope of delivery:

Tent skin, poles (steel), porch pole, wind screen, curtains, storm bracing, guy ladders, pegs and bag

936373

899,--



Front and side walls  
completely removable







# CASA ROYAL 2



Tested in Finland



from 949,-

Photo shows CASA ROYAL 320



Photo shows CASA ROYAL 390

Mounting height: 235 - 255 cm 



## CASA ROYAL 2 - 320, 390 winter tent

- Winterproof roof
- Sturdy steel frame
- Poles with hurricane supports as standard
- 2 doors in the breathable side walls
- Double foul stripes

The side walls made of spun-dyed isoacrylic offer a pleasant living climate like cotton. Front wall with 4-way zipper can be opened from both sides and is removable. Front window made of foil with curtains. Upper side window w/ mosquito net & foil cover outside, bottom window in foil w/ curtains. Frame w/ additional hurricane supports next to doors, porch pole & ridge reinforcement as standard.

**Ventilation:** Sealable floor vents on both sides as well as forced ventilation in upper corners. Sealing to the caravan with foam bead and bent pressure rods.

**Scope of delivery:** Tent skin, steel poles with Quick Lock Padset, ventilated ceiling, curtains, wind and wheel cover. Storm bracing, lines, pegs.

Model	ca. 	ca. 	Item no.	Price
CASA ROYAL 2 320 cm	47,5 kg	110 x 42 x 38 cm	936392	949,-
CASA ROYAL 2 390 cm	57 kg	110 x 42 x 43 cm	936382	999,-

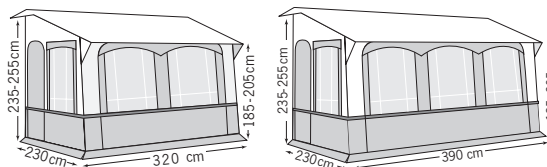

Attachment to the vehicle:  
• Piping Ø 7 mm

### Spare parts

Ventilated ceiling		Curtain set		Steel rods	
936393	59,95	936394	65,95	936391	379,-
936383	59,95	936384	65,95	936381	399,-

### Optional accessories (for CASA ROYAL 2 320 and 390):

Winter set CASA ROYAL steel 1 hurricane support, 4 adjustable ridge poles 6,2kg	936351	99,95
Steel herringbone (5 pcs.)	90275	9,99
Floor tiles 60 x 60 cm (4 pcs.)	90445	20,90

Walls 100% acrylic

Steel Ø25/22mm

Roof 100% PVC

Flame retardant



 from **189,-**
**NEW** 3 new sizes

### Caravan roof covers Wintertime

- Protection against rain, snow & moss build-up during winter
- Protects the seals from UV rays and extends the lifetime of your vehicle
- Tear resistant
- Quick assembly

Material: Breathable, 3-ply SFS-3 NONWOVEN.

All protective covers have an eyelet strip, tensioning straps on the front and backside as well as triangular straps for tensioning all around.

**Scope of delivery:** Protective cover, tensioning material, bag, repair kit

**Safety note:** Not suitable for driving.

Color	Weight	Length x width	Art. no.	Price
Grey	5,5 kg	500 x 300 cm	928081	189,-
Grey	5,8 kg	550 x 300 cm	928082	199,-
Grey	6,0 kg	600 x 300 cm	928083	209,-
Grey	6,4 kg	650 x 300 cm	928084	219,-
Grey	6,6 kg	700 x 300 cm	928085	229,-
Grey	6,8 kg	750 x 300 cm	92808	239,-
Grey	6,9 kg	800 x 300 cm	928086	249,-
Grey	7,0 kg	850 x 300 cm	928087	259,-
Grey	7,1 kg	900 x 300 cm	928090	269,-
Grey	7,2 kg	950 x 300 cm	928097	279,-
Grey	7,3 kg	1000 x 300 cm	928098	289,-

**Accessories:**

Spare set with 6 tensioning belts, 3cm wide, ca. 800cm long (with snap hooks).



928088

45,-

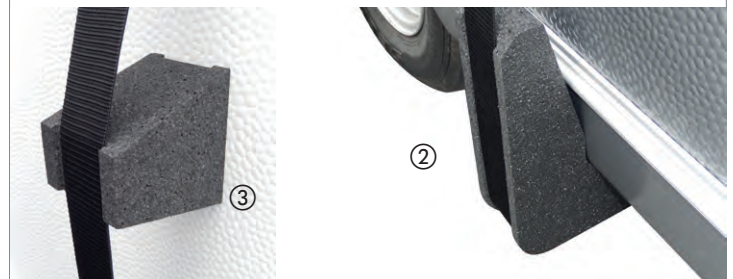
**NEW**

### Accessories for protective covers/tarpaulins

**① Gable protection profiles, 2pcs.**

- Improved the air circulation and prevents waterlogging
- Flexible use
- Side openings (Ø 25mm) for guide poles add additional stabilization (poles not included)
- Makes the water drainage from your protective cover or roof tarpaulin easier
- Prevents or reduces possible water build-up.

Gable height ca. 26cm towers above roof windows and antennas.

**Material:** Weathering resistant, solid PE foam. It is assembled in the middle and stabilized with 4 feet each. Placement and number of spacer profiles is determined by the respective requirements.

**Content:** 2pcs. (only available in pairs, can also be used for roof tarpaulins), 8 feet. Package length: Only ca. 120cm, assembled size ca. 210 x 26 x 5cm

928640

99,-

**② Protective corners, 4pcs.**

are used to securely guide the tensioning straps and distribute the tensioning force evenly over the plastic edge

928641

75,-

**③ Spacer, 4pcs.**

prevents the belts from resting on the vehicle

928642

35,-

### Caravan bow protection tarpaulin Supra

- Protects the interior from sunlight
- Protects the bottle box from snow and icing
- Prevents possible drafts
- Breathable
- Can also be used on the back

Material breathable Tyvek Supra-FC.

Use: Pull the textile piping (Ø 7mm) in the piping rail and tensions with eyelets on the lower edge (rupper tensioner included)



Width x length	Art. no.	Price
140 x 160 cm	904797	99,-
180 x 160 cm	90479	99,-
200 x 160 cm	904791	99,-
240 x 160 cm	904795	115,-
240 x 200 cm	904796	119,-





**Drawbar weather protection**

Protection for drawbar and support wheel.

Dimensions 120 x 63cm, color: black, material: polyester **914950**  
8,95



**NEW**

**Profile for caravan cover**  
2pcs., 210 x 26 x 5cm, 4 feet  
per profile

Use between vehicle roof and tarpaulin / mold protection / provides ventilation

2pcs. **928645** 79,95



**Corner protection spacer**  
4pcs. per set

- Ideal for use with caravan protection canopy/protective cover
- Protects your caravan from damage
- Extra lightweight made of EPP (polypropylene)

① **Spacer:**

Dims. 12 x 12 x 7,5 cm, weight: 0,1kg  
4 pieces **928643** 14,95

② **Corner protection:**

Dims. 27,5 x 17,5 x 7,5 cm, weight: 0,15kg  
4 pieces **928644** 24,95



**NEW**

**Piping tape 12m long Ø 6mm**

- Protects the piping rail from dirt (when not in use)
- Ensures that awning can easily be pulled in
- Prevents black rain streaks

Material: PVC **904498** 17,95



**Pull-on aid for caravan & motorhome covers**

Practical help to get protective canopies or protective covers over the caravan  
Telescopic 71 - 120 cm,  
material: aluminum, with hooks.

**903075** 9,95



**Caravan protection canopy**

- Reliable weather protection, breathable
- Reduces the risk of mold
- Waterproof and UV resistant

Caravans are exposed to the weather - especially when the vehicles are parked in outdoors. Rainfall and intense sunlight but also dust, dirt, bird dropping or tree resin leave their marks over time. A protective canopy helps preserve the look and lifetime of your vehicle.

Color: Grey  
Material: 3-ply SFS fabric 160g/m<sup>2</sup>

from **119,-**

Width x length	Art. no.	Price
505 x 300 cm	<b>92862</b>	<b>119,-</b>
555 x 300 cm	<b>92863</b>	<b>129,-</b>
605 x 300 cm	<b>92864</b>	<b>139,-</b>
655 x 300 cm	<b>928622</b>	<b>149,-</b>
705 x 300 cm	<b>928623</b>	<b>169,-</b>
755 x 300 cm	<b>928624</b>	<b>189,-</b>



**Belt dims.:** Important for determining size, please take bike racks & overhangs into account.





**Premium protective caravan cover - available in 2 widths**

- Breathable, watterrepellent, weatherproof
- Preserves the value of your caravan
- Access to caravan possible
- Canopy of breathable material for ideal UV protection
- Both sides can be opened with zippers and rolled up
- Good ventilation to reduce risk of mold

Material: 3-ply SFS fabric: roof 125g/m<sup>2</sup>, sides 100g/m<sup>2</sup> (grey)

**Width: 230cm, height 220cm**

Length top / bottom		
445 / 520 cm	<b>928541</b>	<b>239,-</b>
505 / 580 cm	<b>928542</b>	<b>249,-</b>
565 / 640 cm	<b>928543</b>	<b>259,-</b>

**Width: 250cm, height 220cm**

Length top / bottom		
475 / 550 cm	<b>928544</b>	<b>239,-</b>
515 / 590 cm	<b>928545</b>	<b>249,-</b>
555 / 630 cm	<b>928546</b>	<b>259,-</b>
595 / 670 cm	<b>928547</b>	<b>269,-</b>

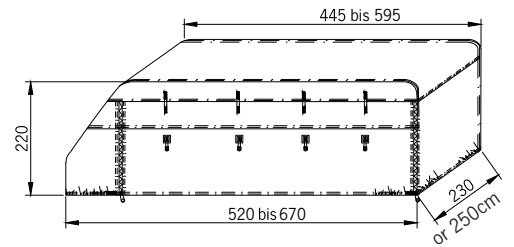

Suitable for caravans with a length from 520 to 670cm and a width from 230 or 250cm

**Caravan protective cover - available in two widths**

- Protects from UV-rays, water, dust, dirt and other weather influences
- Can be opened with zipper and rolled up
- Breathable, weatherproof and UV-resistant
- Good ventilation, reduction of mold risk

Material: 3-ply SFS fabric: 160g/m<sup>2</sup>

Access is possible at any time thanks to the roll-up side walls.

**Width: 230cm, height 220cm**

L 460-520cm	<b>928628</b>	<b>169,-</b>
L 520-580 cm	<b>928629</b>	<b>189,-</b>
L 580-640 cm	<b>928630</b>	<b>209,-</b>
L 640-700 cm	<b>928631</b>	<b>229,-</b>
L 700-760cm	<b>928632</b>	<b>249,-</b>

**Width: 250cm, height 220cm**

L 470-510 cm	<b>928633</b>	<b>199,-</b>
L 510-550cm	<b>928634</b>	<b>209,-</b>
L 550-590cm	<b>928635</b>	<b>219,-</b>
L 590-630cm	<b>928636</b>	<b>239,-</b>
L 630-670cm	<b>928637</b>	<b>259,-</b>
L 670-710 cm	<b>928638</b>	<b>269,-</b>

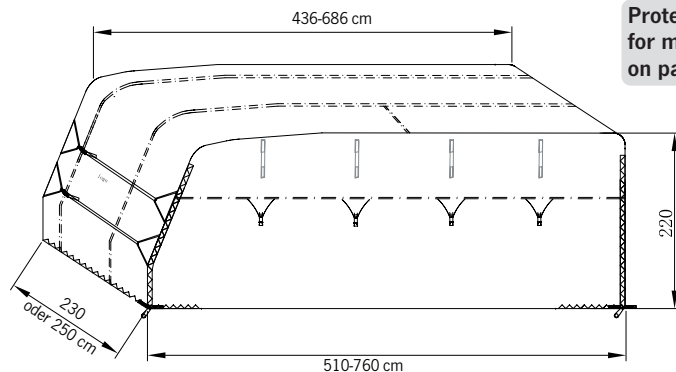

Protective covers for motorhomes on page 69





**Floor skirt**

Tarpaulin made of 210T polyester, PVC coated. With two large zippered pockets and two small pockets. Incl. bag. Weight 3.3kg. Dims.: W 600 x H 45 + 15cm

Light grey    **90599**    **62,95**

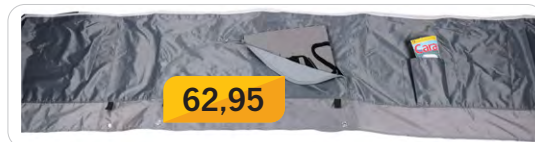

**Floor skirt**



Winterproof tarpaulin with textile piping. Foil ca. 30% thicker than usual. Plastic eyelets welded in at 50cm intervals. Color: Light grey

<b>Height 50cm</b>	<b>5 meters</b>	<b>904720</b>	<b>57,95</b>
	<b>25 meters</b>	<b>904725</b>	<b>287,50</b>
<b>Height 75cm</b>	<b>5 meters</b>	<b>904726</b>	<b>62,50</b>
	<b>25 meters</b>	<b>904729</b>	<b>375,-</b>



**Wheel cover**

Universal for 14-17 inch wheels

Material: 900D Oxford Polyester / PVC Incl. eyelets for fastening

Color: Grey

<b>14-15 inches:</b>	<b>904709</b>	<b>9,95</b>
<b>16-17 inches:</b>	<b>904708</b>	<b>10,95</b>



Tandem model



**Tire protection cover Reflex - for cars, caravans and motorhomes**

The cover has a reflective front surface to keep out UV-rays that damage the tire, thus reducing the effect of heat. The cover rests on the running surface and cannot slide off. The incorporated piping gives shape and support. Built-in eyelets for ground nails serve secure fastening.

Cover dims. W 635 x D 185mm, for e.g. for 14"	<b>90477</b>	<b>17,50</b>
Cover dims. W 665 x D 215mm, for e.g. for RM 15", 215/70/R15	<b>904704</b>	<b>19,-</b>
Cover dims. W 690 x D 225mm, for e.g. for RM 16", 235/75/R16	<b>904771</b>	<b>22,50</b>
Cover dims. W 740 x D 225mm, for e.g. for RM 17", 225/75/R17	<b>904770</b>	<b>25,-</b>
Cover dimensions up to Ø 780mm, for example for SUV's	<b>904705</b>	<b>27,50</b>
Envelope dim. 1550 mm long, for tandem	<b>904706</b>	<b>32,50</b>

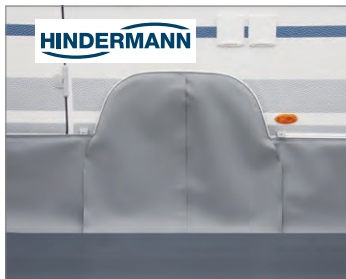

**Wheel arch cover**

Winterproof, ca. 430g/sqm. Textile piping to pull in, height ca. 1m.

**For single axle:**

<b>Fendt from YOC 2011</b>	<b>904788</b>	<b>37,50</b>
<b>Fendt from 2015</b>	<b>904787</b>	<b>37,50</b>
<b>Hobby</b>	<b>904772</b>	<b>29,-</b>
<b>Hobby De Luxe, Prestige, Excellent</b>	<b>904789</b>	<b>29,-</b>
<b>LMC (TEC)</b>	<b>904700</b>	<b>29,-</b>
<b>Tabbert</b>	<b>904781</b>	<b>29,-</b>
<b>Bürstner</b>	<b>9047721</b>	<b>29,-</b>
<b>Hymmer Nova/Sporting</b>	<b>904780</b>	<b>29,-</b>
<b>Knaus until '05</b>	<b>904775</b>	<b>29,-</b>
<b>Knaus from '05</b>	<b>904777</b>	<b>29,-</b>
<b>Knaus Sport</b>	<b>904784</b>	<b>29,-</b>
<b>Knaus Südwind</b>	<b>904785</b>	<b>29,-</b>

**For tandem axles:**

<b>Hobby Tandem Prestige, De Luxe</b>	<b>904702</b>	<b>45,-</b>
<b>Hobby</b>	<b>904773</b>	<b>45,-</b>
<b>Tabbert models from 2011</b>	<b>904703</b>	<b>45,-</b>
<b>Tabbert</b>	<b>904782</b>	<b>45,-</b>





**Bow protection tarpaulins with windows for caravans**



- Attachment with piping at the top / with tension hooks at the bottom
- Protects from ice, snow and drafts
- UV protection
- Protects the drawbar box
- Cold resistant down to -40° / heat resistant up to +70°
- Fireproof

Window: H 50cm

Material: tarpaulin: polyester / window: PVC

Made in Europe

Dims. (W x H)	ca.	Art. no.	Price
225 x 140 cm	2,5 kg	904755	139,-
200 x 160 cm	2,6 kg	904756	139,-
240 x 160cm	3,0 kg	904757	159,-



**Gas box cover**

Protection from ice and snow. Winterproof white tarpaulin material with protective coating. Welded piping at top, guy eyelets at bottom.

200 x 90 cm                      9047931                      69,-



**Thermal mat for Adria caravans, 2pcs.**

- Protects from cold and heat
- Attachment with suction cups and Velcro tape
- Suitable for Adria caravans Alpina & Adora series w/ large panoramic window in the front

37324                      143,-



**Thermal for caravan windows**

- Efficient protection from cold, sunlight and heat
- Guy straps to protect against friction on the surface
- Universal attachment
- Roll-up option
- Robust thermal foil with textile piping (Ø 7mm) edged with silverygrey polyester tape



The thermal foil for sunreflection, cold and heat protection is characterized by its low weight and durability

90 x 55 cm	372639	47,50
110 x 74 cm	372632	49,50
130 x 74 cm	372630	53,50
140 x 74 cm	372638	55,-
160 x 74 cm	372633	59,-
170 x 74 cm	372631	62,50
180 x 80 cm	372634	65,-

