





# Tents for camper vans & motorhomes

## Sun sails

## Rear tents

## Awnings



Sun sails/sun canopies  
Page 30 - 39

Rear tents and partition curtains  
Page 39 - 49

Freestanding universal rear tents  
Page 50 - 52

Tour Compact 2 - width 270 cm  
Page 53

## Bus tents



Tour Easy - 3 variants  
Page 54 / 55

Tour Action 7 - width 300 cm  
Page 56

Tour Easy Air - width 300 cm  
Page 57

Newburg Air 160  
Page 58

## Bus tents



## Camper/caravan tents



Troupier Auto-Up  
Page 59

Tour Breeze Air - 3 heights  
Page 60 - 61

One Beam Air High - width 350 cm  
Page 62

Marina Air High - W 330 & 390 cm  
Page 63

## Caravan awnings



Casa Air II - width 390 cm  
Page 64

Tour Ponza Air - width 390 cm  
Page 65

Movelite 2, 3 & 4  
Page 66 - 67

Esprit Pro X 350 M / Sportlite 320  
Page 68

## Caravan awnings

## Pavilions / Functional Tents / Windbreaks



Roof tents and accessories  
Page 70 - 79

Linosa Pavilions  
Page 80 - 81

Functional tents  
Page 82

Wind protection  
Page 83 - 85





from **64,95**

Photo shows Charly Art.90049

**CHARLY & CHARLYNE - Inexpensive sun canopies for mini campers and buses**

- Inexpensive sun canopy
- Vehicle connection with 5+8 mm piping profile, lock bar or loops
- Waterproof and tear-resistant

Plain and simple - the cost-effective solution for the small shade.

**Scope of delivery:**

Awning, airlock pole, 2 steel poles, 3 tube clamps, guy ropes, pegs and packing bag

Model	Charlyne 1.8 for minicamper (LWB)	Charlyne 2.2 for minicamper (SWB)	Charly for Camping buses
<b>Suitable for the following vehicles</b>	Volkswagen Caddy,CitroënBerlingo, Peugeot Partner, Opel Combo, Renault Kangoo, FIAT Doblo, Mercedes Citan, Ford Connect	Volkswagen Caddy Maxi, Opel Combo, Renault Kangoo, FIAT Doblo, Mercedes Citan, Ford Connect.	small buses such as Volkswagen Transporter 5/6,CitroënSpace-tourer, Renault Trafic, etc.
<b>Dimensions</b>	W 180 x D 240 cm	W 220 x D 240 cm	W 255 x D 240 cm
<b>ca. weight</b>	<b>3,8 kg</b>	<b>3,9 kg</b>	<b>4 kg</b>
<b>Item number</b>	<b>90066</b>	<b>90068</b>	<b>90049</b>
<b>Price</b>	<b>64,95</b>	<b>74,95</b>	<b>79,95</b>



from **79,90**

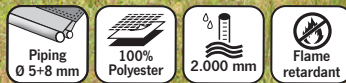

**COMO - The universal canopy**

- Extremely tear-resistant
- Weatherproof and washable
- With 5+8 mm piping connection

**Material:** Awning sizes 1, 2 and 3 made of Oxford polyester 210 D, from size 4 300 D Oxford polyester **Colors:** Light gray or anthracite.

**Scope of delivery:** Awning Size 1 and 2 with two poles, from size 3 with three poles, pegs, guy ropes, packing bag

**Light gray, depth: 240 cm**

Versions	ca.	Art.No.	Price
Size. 1 200 cm	2,5 kg	90020	79,90
Size. 2 250 cm	3,0 kg	90021	89,90
Size. 3 300 cm	3,5 kg	90022	99,90
Size 4 350 cm	4,0 kg	90023	109,90
Size. 5 400 cm	4,5 kg	90024	129,-
Size. 6 450 cm	5,0 kg	90025	139,-
Size. 7 500 cm	5,5 kg	90026	159,-
Size. 8 700 cm	7,5 kg	90019	159,-
Size 10 900 cm	8,5 kg	90017	189,-

**Anthracite, depth: 240 cm**

Versions	ca.	Art. No.	Price
Size. 2 250 cm	3,0 kg	900212	89,90



Size 8



Size 4 Anthracite





### MAURITIUS - Canopy & sunsail for small and large vehicles

- Sunsail with high variability, shade for large and small vehicles
- Vehicle connection: loops for fastening with suction cups (see page 96) and 5 + 8 mm piping profile
- Eyelets at all corners

The hinged side panels can be tensioned downwards for additional protection.  
 Scope of delivery: Awning, adjustable steel poles max. H 220 cm (2 pcs. for Mauritius M+L, 3 pcs. Mauritius XXL), 6 pegs, 6 guy ropes, stuff sack.



**Mauritius M** (Dimensions sketch ①)  
 Keder length 200 cm, dims.: W 460 x D 300 cm,  
 pack size ca. 66 x Ø 12 cm, weight: 4.6 kg  
**900575 131,-**

**Mauritius L** (Dimensions sketch ②)  
 Keder length 250 cm, dims.: W 510 x D 300 cm,  
 pack size ca. 66 x Ø 13 cm, weight: 5.0 kg  
**900573 139,-**

**Mauritius XXL** (Dims. sketch ③)  
 Keder length 300 cm, dims.: W 560 x D 300 cm,  
 pack size ca. 66 x Ø 16 cm, weight: 6.6 kg  
**900572 159,-**

The tried and tested Mauritius awning is available in the existing 3 sizes in the **RE-TENT** collection

**RE-TENT** the new collection from **Reimo TentTechnology** to protect our nature.



The tent fabrics are made from recycled disposable plastic bottles. Each m<sup>2</sup> is roughly equivalent to 3 x 5 l plastic cola bottles or 9 x 550 ml plastic water bottles.

### MAURITIUS RE-TENT - Awnings in 3 sizes

Made from recycled disposable plastic bottles

- Eyelets in all corners
- Variable tensioning
- For small and large vehicles
- Polyester fabric: Global Recycled Standard

Material: 300D recycled Oxford polyester  
 Vehicle connection: piping Ø5+8mm + loops,  
 Color: Grey  
 Scope of delivery: awning, 2 poles, guy ropes, pegs, stuff sack.  
 See above for dimensions, pack size and weight.



**Mauritius 460** (dimensions sketch ①)  
**900576 139,-**

**Mauritius 510** (Dimensions sketch ②)  
**900577 159,-**

**Mauritius 560** (Dimensions sketch ③)  
**900578 169,-**

### Dimensions all Mauritius models: Sketch ①

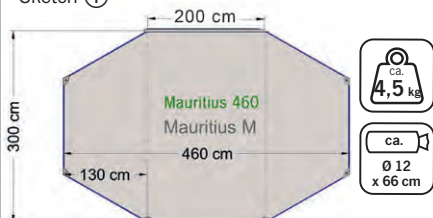

### Sketch ②

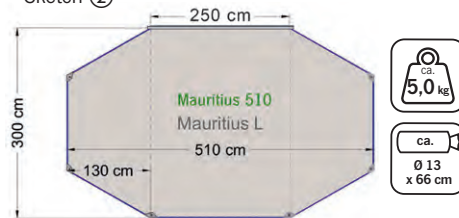

### Sketch ③

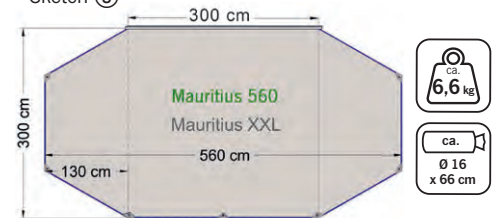





Mounting height:  
190 - 224 cm



### THULE SUBSOLA

Modern, modular panels for an extended living space

- Developed for compact van owners
- For more living space with privacy & weather protection
- Modern, intelligent modularity

Extend the living space outside the awning of your van and enjoy more privacy. The breathable, water-resistant material offers privacy & protection from sun and rain. The triangular panels with high-quality zippers and piping can be combined in different ways for perfect furnishing. With the adjustable pole, you can create more privacy if required, or adjust the Panels when the weather changes. The panels can be stored in a high-quality bag so that you always have everything with you. Available as a side and front package, which can also be combined. You can also add more panels or poles (sold separately) to customize your outdoor furniture to your liking

**Optional accessories**

<b>Thule Subsola Medium Panel</b>	<b>430894</b>	<b>134,-</b>
<b>Thule Subsola Support Bar</b>	<b>430895</b>	<b>74,-</b>

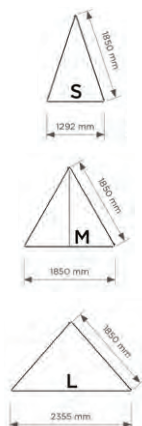

① **Side package 430892**

**429,-**

Scope of delivery:  
2 x Thule Subsola Medium Panel  
1 x Thule Subsola Small Panel  
1 x tension rod  
1 x support bar  
Ropes, pegs and a storage bag

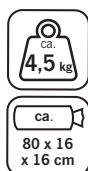

② **Front package 430893**

**279,-**

Scope of delivery:  
1 x Thule Subsola Large Panel  
1 x Thule Subsola Medium Panel  
1 x support bar  
Ropes, pegs and a storage bag

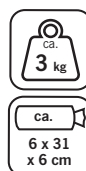

**Compatible with the following awnings:**

T 4200, TO 4900, Thule HideAway, TO 5102, Volkswagen, Thule Sidehill and TO 5200 with 2.60 m length and 2.00 m extension

**Thule awnings can be found from page 163 onwards**



Reflective material

from **39,95**



### SHINE - Awning in 4 widths, for awnings and Multirail

- UV-resistant
- Reflective
- Depth 190 cm
- Easy installation thanks to double piping Ø 5/8 mm

The awning made of UV-resistant, reflective material has a double piping with Ø 5+8 cm, so that it can be used for standard awnings, but also for camper vans with Multirail.

Scope of delivery:  
awning, guy line, pegs, packing bag  
(Support poles must be ordered separately!)  
Material: 185 g/m<sup>2</sup> PE (polyethylene)  
Depth 190 cm, color: silver-grey

Wide	ca.	Ar-No.	Price
240 cm	1,5 kg	906883	39,95
290 cm	1,8 kg	906884	44,95
340cm	2,0 kg	906885	49,95
390 cm	2,2 kg	906886	54,95

**Recommended Support poles:**  
196 cm, 2 pieces **903076** **14,95**

**i** This sail does not protect from rain

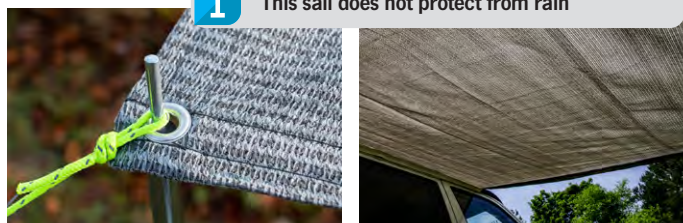
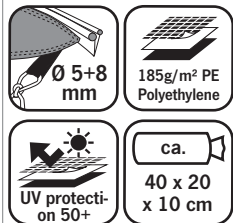





## PALM BEACH - Sun canopy

- Domed roof against water pockets
- Roof with 2 diagonal fiberglass poles
- Spacious feeling
- Double piping Ø 5+8 mm and tunnel

## PALM BEACH QUICK

- With quick assembly system
- Can be opened with 1 handle
- Fixed fiberglass rods
- Color: Light grey/anthracite

## PALM BEACH QUICK 2.6

• Suitable for camper vans with short wheelbase  
 W 260 x D 240 cm, pack size Ø 11 cm x 186 cm, weight: ca. 5.5 kg  
 Scope of delivery: sun canopy incl. fiberglass poles, 2 poles, pegs and guy ropes, packing bag

900159 159,-

## PALM BEACH QUICK 3.0

• Suitable for camper vans with long wheelbase  
 W 300 x D 240 cm, pack size Ø 11 cm x 202 cm, weight: ca. 6.8 kg  
 Scope of delivery: sun canopy incl. fiberglass poles, 3 poles, pegs and guy ropes, packing bag

900169 179,-

## PALM BEACH 2

- Small pack size
- Pockets with Velcro in the corners for easy insertion of the fiberglass rods
- Color: Light grey/anthracite/lime

## PALM BEACH 2 - 2.6

• Suitable for camper vans with short wheelbase  
 W 260 x D 240 cm, pack size Ø 16 cm x 74 cm, weight: ca. 5.5 kg  
 Scope of delivery: sun canopy, 2 fiberglass poles, 2 poles, pegs and guy ropes, packing bag

900151 149,-

## PALM BEACH 2 - 3.0

• Suitable for camper vans with long wheelbase  
 W 300 x D 240 cm, pack size Ø 18 cm x 74 cm, weight: ca. 6.8 kg  
 Scope of delivery: sun canopy, 2 fiberglass poles, 3 poles, pegs and guy ropes, packing bag

900152 169,-

## PALM BEACH Side walls

- Suitable for all Palm Beach sun canopies
- Window with mosquito net and cover inside
- Easy attachment to the roof with velcro
- Mountable on both sides

### ① PALM BEACH side panel

- Narrow width for easy opening of the sliding door

W 225 x H 180 cm, weight: ca. 2.2 kg  
 900153 99,-

### ② PALM BEACH Space side wall

Height of 200cm allows further extension for more space under the sun canopy

W 240 x H 200 cm, weight: ca. 2.5 kg  
 900154 109,-

## Replacement fiberglass rods (2 pieces) for:

### PALM BEACH 2 - 2.6 (900151)

900148 19,95

### Palm Beach 2 - 3.0 (900152)

9001481 19,95

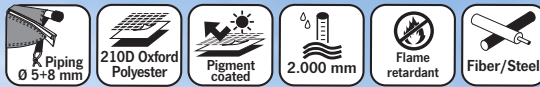

Photo shows Palm Beach Quick



Photo shows Palm Beach







NEW

**SAONA - Sunblock**

**Front panel for awnings**

- Sun protection
- Suitable for all awning types with 6 mm piping rail in the profile
- With eyelets at the bottom for tensioning
- With clips for rolling up
- Mesh fabric, color: grey
- Packing bag included

Material: Mesh fabric (Mesh/PVC)

Piping Ø 5 mm

Scope of delivery: Blocker, Pegs and guy ropes.



Versions	Dimensions (H 190 cm)	ca.	Item no.	Price
SAONA 240	width 240 cm	2,0 kg	44812	79,95
SAONA 280	width 280 cm	2,1 kg	44813	89,95
SAONA 330	width 330 cm	2,3 kg	44814	99,95
SAONA 380	width 380 cm	2,5 kg	44815	109,95
SAONA 430	width 430 cm	2,7 kg	44816	119,95

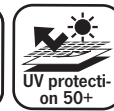

**TECHLINE CANOPY**

- Now available in 3 mounting heights
- Side walls with clear windows
- Reflective storm bracing
- Side windows can be opened and rolled up
- Vehicle connection: 5+7 mm piping profile
- Seams sealed waterproof

Beautifully designed Awning with side panels that can be stowed away to the side.

Easy to set up with just one steel rod.

Scope of delivery: Awning, steel pole, reflective storm lines, pegs, packing bag.

<b>Techline Lowline</b> Height 185-220 cm	900161	149,90
<b>Techline Midline</b> Height 220-255 cm	900162	199,-
<b>Techline Highline</b> Height 255-305 cm	900163	199,-

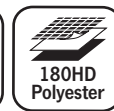
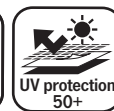
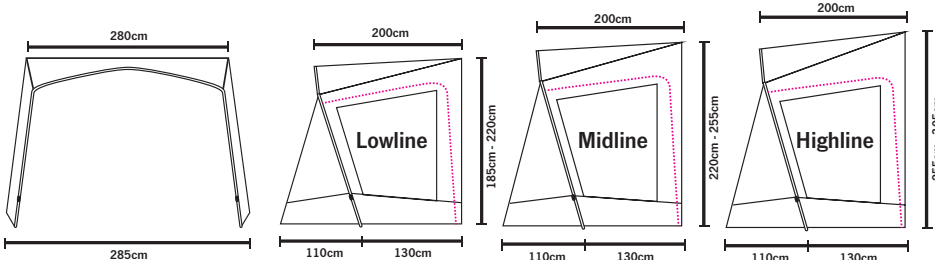





Mounting height:  
190 cm



## MAURITIUS PREMIUM

Flexible sun canopy & awning

- Sun canopy with sewn-on side panels that can be tensioned or rolled up as required
- Domed roof to prevent water pockets
- High-quality premium material
- Available in 2 versions: light gray or anthracite

Stylish and robust sun canopy in premium quality. The domed roof with 2 diagonal rods (fiberglass) scores with a comfortable standing height and prevents water pockets from forming in the rain. The sewn-on side panels can be tensioned or rolled up as desired.

**Scope of delivery:** Awning, 2 pitching poles, 2 fiberglass diagonal poles, lock pole, pegs, guy ropes, packing bag.



Dome roof, no water pockets



from 229,-

Light gray version with diagonally braced side panels



Roll-up side panels

Anthracite version with rolled-up side panels



Light gray version with side panels braced downwards

Width	Color		Item no.	Price
260 cm	Light grey	9 kg	900155	229,-
300 cm	Light gray	10 kg	900156	249,-
260 cm	Anthracite	9kg	900157	229,-
300 cm	Anthracite	10 kg	900158	249,-

**Attachment to the vehicle:**

- Double piping Ø 5+8 mm
- Locking bar
- Anchor loops

300D Oxford Polyester

UV protection 50+

2.000 mm

Flame retardant

Fiber/Steel

ca. 90 x Ø 20 cm

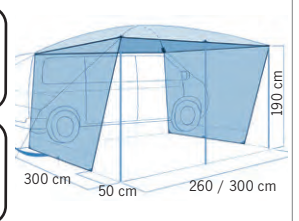

Mounting height:  
180 - 200 cm



## PLAYA VAN

Sun canopy with side walls

- Universal awning for buses
- With large side windows
- Structure with only one fiberglass rod
- Vehicle connection with Ø 5+8 mm Keder profile, Lock bar tunnel and loops

Dimensions: W 260 x D 220 x H 180-200 cm

**Scope of delivery:** Awning, steel and fiberglass poles, pegs, guy ropes, packing bag

Piping length 270 cm    906880    159,-



159,-

Ø 5 +8 mm

185T, 68D polyester

UV protection 50+

1.000 mm

Fiber/Steel

ca. 5,5 kg

ca. 77 x Ø 17 cm





# HISPANIOLA



269,-



Mosquito net doors included in the scope of delivery



Mounting height: 185 - 220 cm

## HISPANIOLA Sunsail and awning in one

- Roof poles prevent water pockets in the rain and provide stability
- Storage pockets in the sides
- Removable front and side panels
- The separate mosquito nets can be used instead of the walls
- Quick assembly with just one fiberglass rod

Multifunctional sunsail/awning for camper vans with a piping rail length from 2.60 cm. The front and side panels can be completely removed and easily stowed away in the pockets sewn inside. The large windows are fitted with tinted film and provide privacy.

Scope of delivery: awning with walls and mosquito nets, fiberglass pole, 3 roof poles, lock pole with clamps, guy ropes, pegs, stuff sack. **90687 269,-**

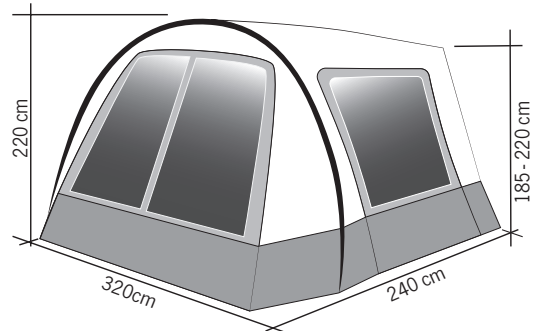

<b>Attachment to the vehicle:</b> • Double piping Ø 5+8 mm • Locking bar • Anchor loops	UV protection on 50+	3.000 mm	Fiberglass
	190HD polyester	ca. 10 kg	ca. 75 x 21 x 19 cm





# ANTIGUA AIR



399,-

Mounting height: 180 - 220 cm

## ANTIGUA AIR

Practical sunsail, can also be used as an awning

- Quick set-up with just one air hose
- Large windows with interior cover
- Including side panels for hanging (hooks) and front (zipper)

For camper vans with a piping rail height of 180 to 220 cm. The sunsail becomes an awning with 2 side walls that can be hooked in & a front wall that can be zipped in. All walls with large transparent windows and inner cover.

**Scope of delivery:** Awning with air tube, 2 side/ 1x front wall, 2 steel roof poles, guy ropes, pegs, packing bag and air pump.

90688 399,-

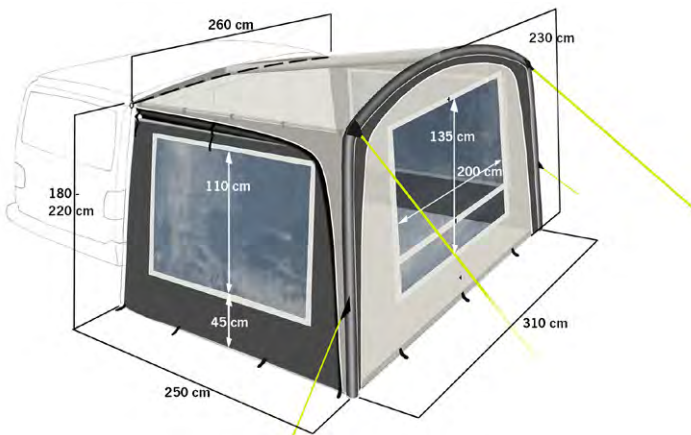

**Attachment to the vehicle:**

- Double piping Ø 5+8 mm
- Locking bar
- Anchor loops

190T polyester

3.000 mm

Seams sealed

Airtube

UV protection

Flame retardant

ca. 13 kg

ca. 70 x 30 28 cm



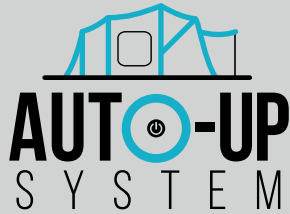

## THE FUTURE IS HERE

Discover the future of outdoor convenience with the revolutionary A.I.S. integrated inflating system. Designed for tents, awnings, and gazebos equipped with air frames, this cutting-edge technology revolutionizes the setup process. With A.I.S., you can say goodbye to the hassle of carrying hand air pumps or electric compressors. Effortlessly inflate your shelter in no time, ensuring a quick and comfortable setup experience. Powered by a rechargeable LiOn battery, A.I.S. provides reliable performance without the need for external power sources. Enjoy the convenience and ease of use that A.I.S. brings, making your outdoor adventures even more enjoyable.



Mounting height:  
180 - 210 cm



### SKIA AUTO-UP

#### Sun canopy

- Automatic inflation thanks to integrated electric pump with rechargeable battery
- Quick and easy to assemble
- Connection with awning tube
- Including bag and assembly accessories
- With sluice bar

Skia Auto-Up sun canopies are the natural evolution of the A.I.R.Tech technology & offer possibility of assembling, inflating and anchoring in just a few minutes and in absolute comfort. At the same time, there is no need to use traditional metal or fiberglass rods. By using the (optionally available) side walls, it is also possible to create a large living space that is protected from wind, weather and indiscreet glances.



329,90

903736

329,90

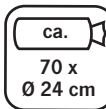

you can find more  
AUTO-UP models  
on page 38

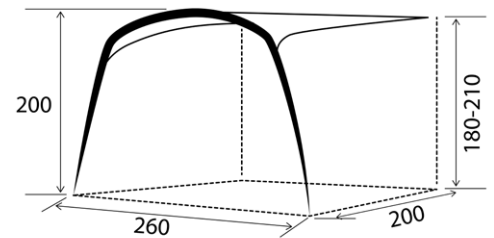

34,95

### 2 in 1 privacy screen and Shower curtain for the van tailgate opening

Suitable for: Volkswagen T5/T6 / T6.1, Multivan, ID Buzz, Mercedes Vito, V-Class, Marco Polo, Metris, all 3 lengths, > 2014 Renault Trafic, Opel Vivaro B, Nissan NV 300, > 2001, Fiat Talento > 2016, LWB+SWB Citroën Spacetourer / Jumpy, Peugeot Traveller / Expert, Toyota Pro Ace Verso > 2016, Opel Zafira Life / Vivaro C > 2019, all 3 lengths, Ford V 710 >2023, Transit, Custom H1 and Nugget.

- Privacy screen, blackout and curtain in one
- Shower without getting wet in the rear
- Simple fixation
- Suitable for almost all panel vans

The privacy screen can be used with or without a rear tent (no tight seal). Simply attach over the tailgate with the adjustable strap and fix to the bumper with plastic hooks if needed. Water column 2,000 mm, dimensions: ca. 153 x 186 cm, weight ca. 0.5 kg.

Color grey

936287

34,95







Mounting height:  
235 - 250 cm



### PLAYA AIR 300 & 400 Universal air sunsail

- Awning with 1 air tube
- Quick assembly and dismantling
- Low weight
- Side panels can be removed with a zipper
- Storm bracing included
- Connection with keder profile Ø 7 mm

**Scope of delivery:**

Awning, air tube, 2 side walls, air pump, pegs, storm bracing, guy ropes, carrying bag.

Width	Piping length	Art. no.	Price
300 cm	306 cm	906887	339,--
400 cm	405 cm	906888	379,--

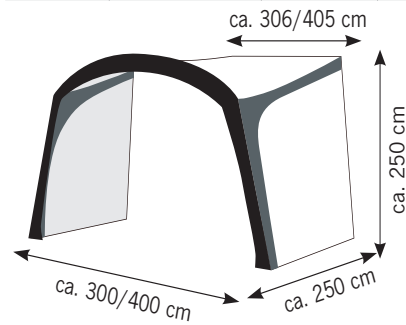

For use on an awning, we recommend our travel keder adapter (page 99)



Side walls can be easily removed with zipper



Piping Ø 7 mm	150D Oxford Polyester	UV protection 50+	2.000 mm
Airtube	ca. 7,0 kg/ 7,5 kg	ca. 77x Ø 17 cm	



39,--



### Privacy screen, shower/shower Partition curtain, awning for Fiat Ducato & large vans with hinged doors

- Easy attachment via Velcro

Suitable for: Fiat Ducato

The curtain can be used as a privacy screen or shower/partition curtain. The attachment is made by Velcro directly to the vehicle. The curtain can also be used as a sun awning. Scope of delivery: sail, pegs, guy ropes, pack sack. (Support poles must be ordered separately!)

Dims.: ca. L 200 x W 165

936291 39,--

190T Polyester	2.000 mm	UV protection coated
Flame retardant	ca. 1,5 kg	ca. Ø 25 x 75 cm

**RECOMMENDED ACCESSORIES:**

Support bar  
903070 28,95

Further support poles on page 90







119,-

**TRAPEZOID**

Rear tent (for tailgate)

Suitable for Volkswagen Caddy (<2020), Kangoo II (type W 2008-2020), Doblo, Partner Berlingo (2008-2017 type B9), Citan.

- Without linkage
- Low weight
- Space for a camp bed

No poles, small pack size & easy pitching make the Trapeze rear tent the perfect choice. The PVC window in the roof provides more light.

**Scope of delivery:** Tent, pegs, stuff sack (pitching poles not included)

93791 119,-

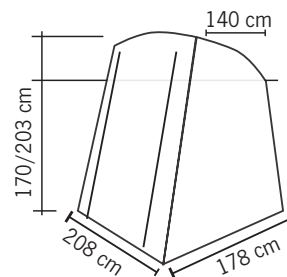

FIT:		
Telescopic uprights with clamping screw, Steel Ø 22 mm, 3-part, ca. 165 - 250 cm,	90307	34,30
Aluminium Ø 25 mm, 3-teilig, ca. 170 - 260 cm,	903070	28,95

100% Polyester RipStop 190D	3.000 mm	Seams sealed	without linkage
UV protection coated	Flame retardant	ca. 2,4 kg	ca. Ø 17 x 60 cm



99,-

**VERTIC** Rear tent (for tailgate)

Suitable for: Volkswagen Caddy (2003-2020) LWB/SWB, Kangoo II (type W 2008-2020), Mercedes Citan (2012-2020), Citroën Berlingo II (type B9), Peugeot Partner Tepee (2008-2017), Fiat Doblo II (type 263, 2010-2022), Opel Combo ("D" 2012-2017) and others

- Without linkage
- Low weight and quick assembly
- PVC windows in the roof for more light

The Vertic rear tent can be set up quickly and easily without poles. Rear wall can be raised as an sunsail.

**Scope of delivery:** tent, pegs, Velcro tape & packing bag (pitching poles not included)

93792 99,-

Description as above,

**Dimensions:** W 130 x H 195 x D 132 cm

93795 119,90

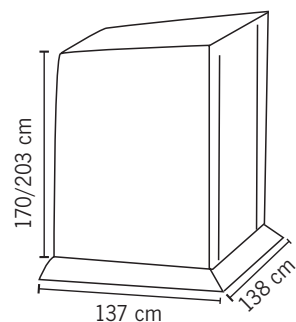

100% Polyester RipStop 190D	3.000 mm	Seams sealed	without linkage
UV protection coated	Flame retardant	ca. 2,1 kg	ca. Ø 17 x 50 cm





## VOLKSWAGEN CADDY 5 PREMIUM Rear tent (for tailgate)

Suitable for: Volkswagen Caddy 5 LWB/SWB (>2021), Ford Connect 3 and Grand Connect

- Without linkage
- Mosquito net in both sides and front wall
- Front door can be used as an awning
- incl. removable base

The rear tent is simply pulled over the tailgate and secured with sewn-on straps and plastic hooks. The front wall is equipped with a large zippered door (with additional mosquito net), which can also be used as an awning. Side walls each have a zippered door with an additional mosquito net layer and the roof has a PVC window above the rear window. The groundsheet is attached with Velcro and can be removed at any time.

Floor plan dimensions: 240 x 190 cm

**Scope of delivery:** Tent skin, 2 pitching poles, groundsheet, pegs, guy ropes, stuff sack

937911 249,-



 100% polyester RipStop 190T	 3.000 mm	 Seams sealed	 without linkage
 UV protection coated	 Flame retardant	 ca. 4,5 kg	 ca. Ø 22 x 60 cm



## Sandcrest S + L - Freestanding rear tents

- Easy to attach and remove
- Large window with mesh insert & waterproof curtain
- User-friendly, robust zippers
- Vehicle tailgate can be opened from the rear tent
- Tailgate can be closed and locked with the tent attached

Compact rear tent for camper vans. Perfect for camping and short trips for cooking, as a day shelter or changing room. You'll appreciate the value of the extra space the ingenious Sandcrest S and L offer for a more comfortable van life. Thanks to the intelligent design, you can close and lock the tailgate securely, or leave the tailgate open at night while you ensure good ventilation in the van with the internal insect screen. With just one aluminum arch, it can be set up very quickly and has a very small pack size. Thanks to the clever fastening system, sliding doors are not blocked by guy ropes. There is an insect protection window in the large tent entrance which can be closed with a waterproof curtain. As a bonus, you can set up the door as a sun canopy. (support poles not included in scope of delivery)

**Scope of delivery:**

Tent skin, poles, guy material, packing bag

① Sandcrest S Bus height 155 cm-185 cm

Suitable for:

Volkswagen Caddy Citroën Berlingo etc.  
9000950 479,-

② Sandcrest L Bus height 175-205 cm Suitable for: Volkswagen T5/6, MB Vito and similar.

9000951 499,-



 UV protection coated	 Outtex® 3000 Select, 100% Polyester	 3.000 mm	 Flame retardant	 Aluminium 6061-T8, 13 mm anodized
--------------------------	---	--------------	---------------------	---------------------------------------

① Sandcrest S



ca. 4,4 kg

ca. 62 x 20 x 20 cm

② Sandcrest L



ca. 5,3 kg

ca. 64 x 21 x 21 cm





**Rear sunroof**

Suitable for: Volkswagen T5 / T6 / T6.1 with hinged doors

- Robust weather protection
- Protection from sun, rain and draughts
- Quick and easy to install
- no bracing required on the ground

The sun canopy is stretched over the open rear doors and serves as sun/rain protection, but also reduces draughts when the doors are open. A telescopic tension rod between doors defines distance and holds tarpaulin in place. It is connected to the vehicle by means of an adjustable elastic strap and plastic hooks, and secured with magnets. Quick and easy installation without modifications to the vehicle

**Dims.:** ca. width 160 x depth 80 cm

**Scope of delivery:**

Sun canopy, 1 tension rod (aluminum), pannier bag

937983 119,-



**UPGRADE DOME PREMIUM  
Rear tent (for hinged doors)**

Suitable for: Volkswagen T5 / T6 / T6.1 , also suitable for Renault Traffic and similar models

- Domed roof with window for a generous feeling of space
- Considerable space expansion
- Doors can be closed when the tent is erected
- Trough-shaped floor tarpaulin protects against moisture and draughts
- Front with mosquito net
- Spacious and stable
- Australian standard

The highlight of the Upgrade Dome Premium rear tent: the wing doors can be closed when the tent is set up. Domed roof gives generous feeling of space & at the same time prevents water pockets when it rains. The U-shaped tubular steel frame promises stability. The front wall has a large door (can be used as an awning) and a transparent window with inner cover and additional mosquito net. The side walls with oval windows and the skylight window in the roof ensure good all-round visibility. A groundsheet with integrated wind protection under the bumper, which is secured with Velcro, completes the tent.

**Dimensions:** W 250 cm x D 210 cm H 210 cm

**Pack size:** ca. 95 cm x 20 cm x 22 cm

**Scope of delivery:** Tent, groundsheet, steel frame, 2 fiberglass poles, 2 steel pitching poles, guy ropes, pegs, packing bag

936292

349,-

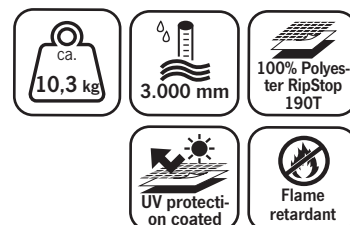
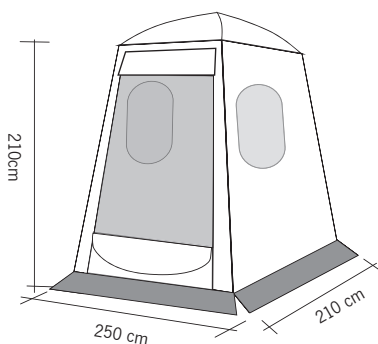





# VAN UPGRADE PREMIUM



269,-

## VAN UPGRADE PREMIUM

### Rear tent (for tailgate)

Suitable for: Ford Transit Custom / Tourneo Custom (>2023)  
 Volkswagen New Transporter (>2025)  
 Renault Trafic II and III (>2001)  
 Nissan NV 300 / Primastar (>2002)  
 Citroen Spacetourer / Jumpy (>2016), Pössl Campster / Vanster  
 Peugeot Traveller / Expert (>2016)  
 Toyota Proace Verso / Proace (>2016)  
 Opel Vivaro A, B (>2001), C (>2019), Zafira Life (>2019)  
 Fiat Talento (2016-2021), Scudo / Ulysse (>2022)  
 Ford Transit Custom / Tourneo Custom (2012-2022)

- No linkage
- Mosquito net in front & side walls
- Skylight for skylight
- Top ventilation
- E sewn-in floor pan up to the bumper
- Quick and easy assembly
- Door with window - can be set up as an awning
- Additional usable space, e.g. as a changing room, shower tent, etc.

The rear tent is simply pulled over the tailgate and attached to the vehicle with clips or pegs on the ground.

The additional space created can be used flexibly, e.g. for bicycles, a dog bed or camp bed, as a changing room or shower cubicle, etc.

Thanks to the mosquito net in all doors and the sewn-in floor pan up to the bumper, you are protected from mosquitoes and other insects.

**Dimensions:** ca. W 145/220 x L 155/230 x H 193-205 cm

**Pack size:** ca. 95 cm x 20 cm x 22 cm

#### Scope of delivery:

Rear tent, guy ropes, pegs, 2 pitching poles, stuff sack.

937994

269,-

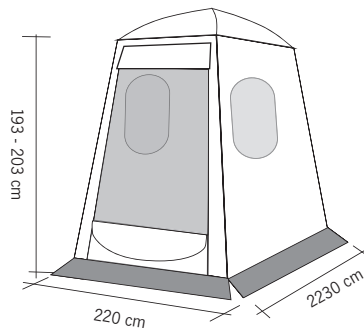





**INSTANT**

Quick set-up tent for Volkswagen Transporter 5/6 (with tailgate)

- No linkage required
- Low weight - only 2.4 kg
- Simple structure
- Changing room at the bathing lake
- Shower tent at the rear

The rear tent is sewn to the rear bag and is attached to the tailgate with press studs (still need to be attached). This means the tent can simply remain stowed in the tailgate

93790 149,90

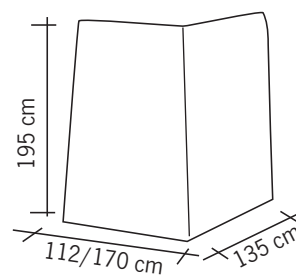

100% polyester RipStop 190D	Seams sealed	without linkage
UV protection on coated	Flame retardant	ca. 2,4 kg
		ca. Ø 16 x 45 cm

**Floor for rear tents**

- Rear tent floor with integrated windbreak
- Easy to attach to the rear tent using Velcro fasteners on the tent wall

Material: PE

Scope of delivery: Rear tent floor with 6 eyelets, including pegs, 3 plastic hooks & Velcro tape for attachment to rear tent & vehicle.

For the Trapez and Vertic rear tents, for Trafic and Hiace:

Dimensions: 250 x 220 cm  
936288 29,90

For the rear tents Upgrade, Update:

Dimensions: 240 x 210 cm  
936289 29,90







## UPGRADE PREMIUM - Rear tent with premium equipment

Suitable for: Volkswagen Transporter 5/6, also Multivan + California, ID Buzz (with tailgate)

- All 3 doors with mosquito net zipped doors
- Sewn-in bottom tray, closes with rear entrance
- PVC windows in the roof
- Transparent windows with inner cover
- Australian standard

No poles, small pack size, light weight and easy set-up make the Upgrade Premium rear tent the perfect rear tent for van drivers. Features such as mosquito nets in all zippered doors, bumper skirt and sewn-in floor pan offer protection against mosquitoes and insects. The front door can be set up as an awning.

**Scope of delivery:** Rear tent, guy ropes, pegs, 2 pitching poles and pack sack.

936286 249,-

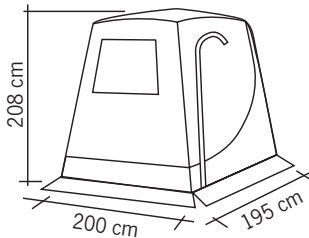



Clips for body mounting



Ventilation above the entrance

Sewn-in floor pan up to rear entrance, with mosquito net



## UPGRADE 2 -

More living space for Volkswagen Transporter 5 / 6 / 6.1 - also Multivan + California, ID Buzz (with tailgate)

- Without linkage
- Low weight
- PVC windows in the roof
- Additional usable space e.g. changing room, shower tent, etc.

Windows and doors in the front and both side walls. Simply slip it over the tailgate and there is space for a camp bed, bicycle or simply to get more fresh air in the vehicle. Front can be raised as a sun awning. The PVC window in the roof provides more light.

**Scope of delivery:** Tent, guy ropes, pegs, 2 pitching poles and stuff sack.

Color grey/anthracite/lime

936280 159,90



159,90

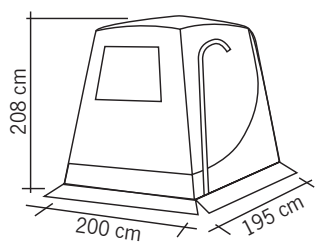



229,-



Sewn-in base tray

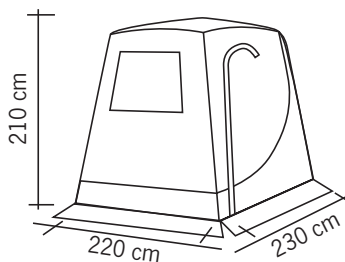

- 190T ripstop polyester
- UV protection coated
- 3.000 mm
- Flame retardant
- without linkage
- ca. 4,5 kg
- ca. Ø 30 x 60 cm

### TRAPEZE PREMIUM

#### Rear tent (for tailgate)

Suitable for : Renault Trafic II and III (>2001), Nissan NV 300 / Primastar (>2002) , Citroen Spacetourer / Jumpy (>2016), Pössl Campster / Vanster, Peugeot Traveller / Expert (>2016), Toyota Proace Verso / Proace (>2016), Opel Vivaro A, B (>2001), C (>2019), Zafira Life (>2019), Fiat Talento (2016-2021), Scudo / Ulysse (>2022) , Ford Transit Custom / Tourneo Custom (2012-2022)

- Without linkage
- Mosquito net in front and side walls
- Additional usable space
- Australian standard

Features such as a mosquito net in all zippered doors, a bumper skirt and a sewn-in floor pan offer protection against mosquitoes and other insects. The front door has an additional mosquito net window and can also be set up as an awning. The sewn-in floor pan can be attached to the bumper with Velcro. The window in the roof can still be used as a skylight.

The rear tent is simply pulled over the open tailgate and then attached to the vehicle and floor.

**Scope of delivery:** Rear tent, guy ropes, pegs, 2 pitching poles and packing bag

937962                      229,-



159,-



- 100% polyester RipStop 190T
- UV protection coated
- 3.000 mm
- Flame retardant
- ca. 3,5 kg
- ca. 55 x 30 x 16 cm

### TRAPEZ TRAFIC

#### Rear tent without poles (for tailgate)

Suitable for: Renault Trafic II and III (>2001), Nissan NV 300 / Primastar (>2002), Citroen Spacetourer / Jumpy (>2016), Pössl Campster/ Vanster, Peugeot Traveller / Expert (>2016) - Toyota Proace Verso / Proace (>2016) , Opel Vivaro A, B (>2001), C (>2019), Zafira Life (>2019), Fiat Talento (2016-2021), Scudo / Ulysse (>2022), Ford Transit Custom / Tourneo Custom (2012-2022)

- Both side panels and front with door
- Window with inner cover
- With window in the roof as skylight

With extra large interior, for camp bed, bicycles, or similar. Rear tent simply pull over open tailgate & attach to the ground. The front with mosquito net window can also be used as an awning.

**Scope of delivery:** Rear tent, 2 pitching poles, pegs, guy ropes and packing bag

93796                      159,-

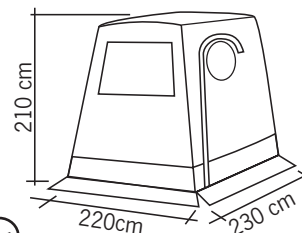





## UPDATE VITO PREMIUM

### Rear tent (for tailgate)

Suitable for:

Mercedes Vito, Marco Polo and V-Class >2015

- Sewn-in base tray
- Mosquito nets in all doors
- Window in the roof for skylight
- Front can be used as an awning
- Australian standard

The rear tent is simply pulled over the tailgate and attached to the vehicle with clips or pegs on the ground.

The additional space created can be used flexibly, e.g. for bicycles, a dog bed or camp bed, as a changing room or shower cubicle, etc. Thanks to the mosquito net in all doors and the sewn-in floor pan up to the bumper, you are protected from mosquitoes and other insects.

**Scope of delivery:** Rear tent incl. pegs, guy rope, stuff sack, 2 pitching poles

936290 249,-

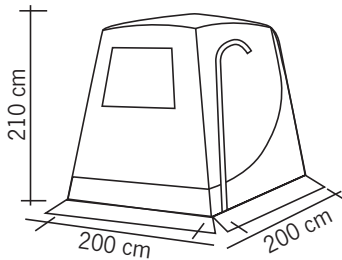

249,-

Ventilation above the entrance

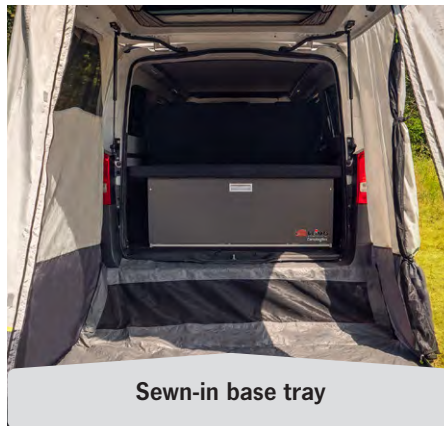

Sewn-in base tray



- 190T ripstop polyester
- UV protection coated
- 3.000 mm
- Flame retardant
- without linkage
- ca. 4,5 kg
- ca. Ø 30 x 60 cm

## UPDATE

### Quick set-up rear tent (for tailgate)

For Mercedes Vito, Marco Polo, V-Class, EQV, Metris (USA) (>2015)

- No poles, small pack size
- PVC windows in the roof
- Additional usable space
- Front can be set up as an awning

Simply pull the rear tent over the tailgate and there is space for a camp bed, bicycle or simply to get more fresh air in the vehicle.

**Scope of delivery:** Tent, guy ropes, pegs, 2 pitching poles and packing bag

936283 189,-

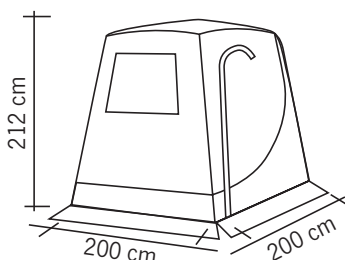

189,-

- 190T ripstop polyester
- 3.000 mm
- PU+UV-coated
- Flame retardant
- without linkage
- ca. 4,4 kg
- ca. 63 x 33 x 31 cm



# ICONS EXPLANATION



Weight



Water column

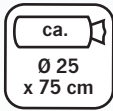

Pack size



Number of sleeping places



Fabric/fabric material



Sealed seams



Surface coating for UV protection



Vehicle connection piping Ø 7 mm



Tent wall material

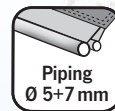

Vehicle connection double piping Ø 5+7 mm



Tent roof material



Vehicle connection double piping Ø 5+8 mm



Breathable material



Vehicle connection double piping, tunnel for lock bar and loops



Flame retardant material

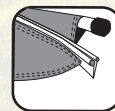

Vehicle connection double piping and tunnel for lock bar



Frame material (steel, aluminum, fiberglass, etc.)



Air tent with air hoses

## Rear door cover

**Sun canopy for the rear doors Suitable for: Fiat Ducato, Citroën Jumper, Peugeot Boxer H2 (> 06/2006), Mercedes Sprinter H2 (2006 - 2008)**

Installed in a few simple steps, with side closures and roll-up front for even more tightness. Upper rafter tensioning rod and piping strip to hold the tension. The double piping rail is attached to the roof eaves of the Ducato.

The Rafter aluminum tensioning rod blocks the opening of the double rear door while tensioning the sunroof.

**Scope of delivery** sun canopy with side closures and roll-up front, double piping rail made of reinforced plastic, tensioning pole for increased stability, tensioning strap kit, ground pegs.

Weight 3,3 kg

434386

258,-







## HARNESS for Toyota Hiace

- Rear tent without poles
- Both side panels and rear panel with door
- Tinted windows with interior cover
- Mosquito net window
- With window in the roof as skylight

### Suitable for Toyota Hiace

With particularly large interior space for camp beds, bicycles, etc. Simply pull the rear tent over the open tailgate and secure it to the ground. The rear wall with mosquito net window can also be used as an awning. With Velcro tape on the side walls to attach the optional tent floor

**Scope of delivery:** Tent skin, including storage bag

937961      199,-

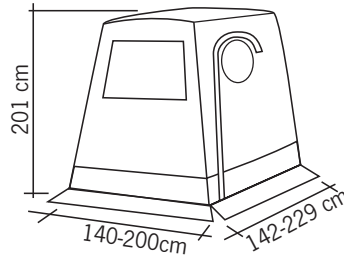

ca. 4,5 kg	Flame retardant	ca. 55 x 30 x 16 cm
2 fold UV protection	100% polyester RipStop 190T	2.000 mm



Rear awning TRAPEZE only suitable for Asia type Toyota Hiace H200 (not available in Europe), not suitable for Europe Hiace type XH10



## DUCATISSIMO PREMIUM

Rear tent for Fiat Ducato (and similar vehicles) with hinged doors

- Premium equipment
- Removable groundsheet
- Mosquito net in door
- Door can be used as an awning

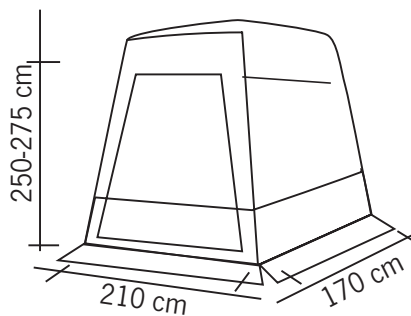

The Ducatissimo Premium rear tent for large vans was developed for Fiat Ducato and similar vehicles with gullwing doors developed. The front wall has a large zippered door with mosquito net & transparent PVC window with cover. This can be rolled up or used as a sun sail. U-shaped tubular frame Ø25/22 mm can be dismantled for a small pack size & is height-adjustable. The connection to the vehicle is made by an adjustable strap and loops. The strong PVC fabric provides a sturdy roof. The removable groundsheet with integrated windbreak under the bumper is attached to the tent and vehicle using Velcro.

**Scope of delivery:** Tent, groundsheet, steel frame, 2 pitching poles, guy ropes, pegs, packing bag

937982      349,-



3.000 mm	ca. 15 kg	ca. Ø 25 x 75 cm	UV protection 50+	3.000 mm	Polyester RipStop 210T	Flame retardant
----------	-----------	------------------	-------------------	----------	------------------------	-----------------





# UNI VAN 2



## UNI VAN 2

Universal rear tent for minicamper and vans with tailgate

- Freestanding
- Side panels and rear panel with door
- Ventilation in roof and floor
- Transparent windows with 1/3 mosquito net
- Extra long airlock with doors on both sides

Universal rear tent for mini campers & vans. Both side walls and front wall with door, which can be used as awnings. Air circulation through ventilation in the roof, sides and floor. Extra long airlock with doors on both sides (140 cm). Tent can also stand freely without a vehicle. Attachment to vehicle: Simply pull it over the open tailgate & tie it off to the side with pegs.

**Scope of delivery:** Tent skin, poles, pitching poles, guy ropes, pegs, stuff sack.

	937984	349,-
Optional Inner tent	937985	59,95
Replacement rods, 1 each:		
Fiberglass rod	937986	9,95
Steel rod	937987	9,95

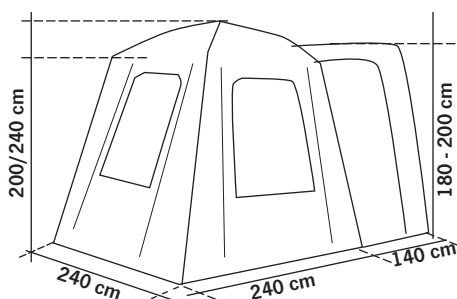

100% polyester 190T	3.000 mm	Seams sealed	Steel/fiberglass 19 mm
PU+ 2x UV coated	Flame retardant	ca. 15 kg	ca. 70 x 21 25 cm







## UNI VAN AIR

Inflatable universal rear tent with dome roof (for tailgate)

- Freestanding rear tent
- Side walls and rear wall with door and 1/3 mosquito net
- Top ventilator and transparent windows
- Extra long airlock with doors on both sides
- With tent floor (Velcro fastening)

Cross dome roof rear tent with air technology, quick and easy to set up! Both side walls and front wall with door, which can also be used as awnings. Air circulation through ventilation in roof & floor. Extra long airlock with doors on both sides (140 cm). Attachment to vehicle: Simply pull it over the open tailgate and tie it to the side with pegs. Floor is simply attached with Velcro. Separate floor for the airlock with integrated wind protection to the bumper.

**Scope of delivery:** Tent skin with air tube, ground-sheet, air pump, guy ropes, pegs, stuff sack, 2 pitching poles.

	937981	599,-
① Optional inner tent	937988	75,-
Spare air hose	937989	119,-

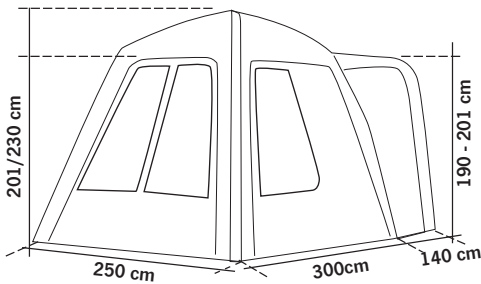

100% polyester	3.000 mm	Seams sealed	Airtube
PU+ UV coated	Flame retardant	ca. 14 kg	ca. 70 x 30 25 cm







**MOVELITE TAIL**

Air rear bus tent with premium equipment

- Canopy over the entrance
- Freestanding
- Tinted windows with curtains
- Extra deep lock, better adapted to the vehicle
- Sewn-in tent floor
- Mounting height 180 to 255 cm

Tried-and-tested Movelite 1 with optimized features such as a lower airlock with mosquito net door, sun canopy over the entrance, roof ventilation on the right & left side & both side doors with mesh panels for better ventilation. Seams sealed. Color: Graphite/Ivory **Scope of delivery:** Tent with air tubes & groundsheet, fiberglass pole for sunroof, roof reinforcement pole, air pump, guy ropes, storm ropes, pegs, stuff sack.

936947 849,-

Mosquito net door 9369332 84,95

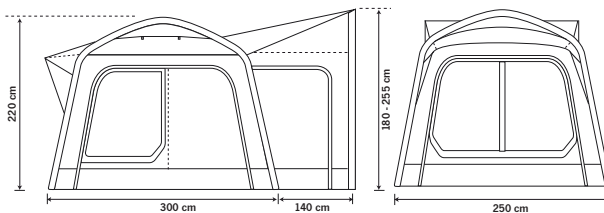

480HDE Polyester	6.000 mm	2x Airtube 1x fiberglass
UV protection	ca. 21,6 kg	ca. 82 x 47 x 40 cm



**MOVELITE TAIL**

Rear bus tent with single inflation

- Only one inflation point
- Freestanding
- Tinted windows with curtains
- Removable base
- Reflective storm bracing
- Air pump included
- Mounting height 180 to 240 cm

Awning made of premium material, which is characterized by excellent strength & durability as well as space-saving properties. Super-fast and easy to set up thanks to the Dura-tech single inflation point tube.

Color: Graphite/Ivory

**Scope of delivery:** Tent with air tubes and groundsheet, air pump, guy ropes, storm ropes, pegs, stuff sack.

93799 749,-

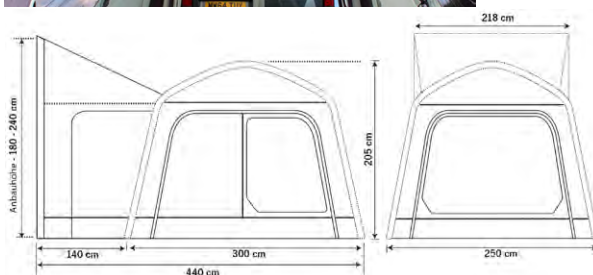

250HD RipStop Polyester	4.000 mm	2x Airtube
UV protection	ca. 18,2 kg	ca. 78 x 46 x 31 cm





Mounting height:  
170 - 190 cm



## TOUR COMPACT 2

Tunnel tent for mini campers and vans

Suitable for: Volkswagen Caddy, Mercedes Citan, Renault Kangoo, Ford Connect, LWB + SWB, Citroën Berlingo, Peugeot Partner

- Freestanding
- Both side windows with 2/3 transparent PVC + 1/3 mosquito net - with outer cover
- Bottom ventilation on both sides and 2 top vents in the front
- Large front door (width 140 cm), which can be rolled up or used as an awning
- Door in rear wall (width 180 cm) can be rolled up on both sides, with 1/3 mosquito net
- Roof poles for more stability prevent water pockets in the rain
- Concealed zippers
- Front with 2 side transparent windows with inner cover
- Vehicle connection: piping Ø 5+8 mm, lock bar, tensioning loops

**Scope of delivery:** Tent skin, 2 fiberglass poles, 3 roof reinforcement poles (steel), 1 airlock pole (steel), 2 pitching poles (steel), pegs (steel), guy ropes, packing bag

937013 289,-

### Accessories:

#### Inner tent for Tour Compact 2

2 additional sleeping places, dimensions: W 140 x L 200 cm

937014 35,95

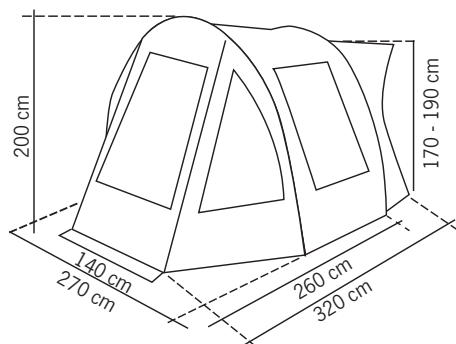

<p><b>Attachment to the vehicle:</b></p> <ul style="list-style-type: none"> <li>• Piping Ø 5+8 mm</li> <li>• Locking bar</li> <li>• Anchor loops</li> </ul>	<p>75D-190T polyester</p>	<p>3.000 mm</p>	<p>Seams sealed</p>	<p>3x fiberglass 11 mm</p>
	<p>UV protection</p>	<p>Flame retardant</p>	<p>ca. 10 kg</p>	<p>ca. 75 x 23 23 cm</p>

### Precisely fitting awning carpet for Tour Compact 2

- Waterproof underside (PEVA)
- Soft upper side (fleece)
- Pleasantly soft feel and protection against cold feet
- Provides additional insulation and enables barefoot walking
- Protects the tent floor
- Easy to clean (not washable)
- Carrying bag included

937012 35,95







# RE-TENT the new collection from Reimo TentTechnology to protect our nature.



The tent fabrics are made from recycled disposable plastic bottles.  
Each m<sup>2</sup> is roughly equivalent to 3 x 5-liter plastic cola bottles  
or 9 x 550-ml plastic water bottles.



**Mounting height:**  
180 - 200 cm



## RE-TENT Tour Easy bus awning

Fabric made from recycled disposable plastic bottles

- Inner roof with coating to reduce the temperature in the tent
- Polyester fabric: Global Recycled Standard
- Airlock with doors on both sides

RE-TENT is the collection from Reimo TentTechnology for the protection of our nature. The tent fabrics are made from recycled disposable plastic bottles. The TOUR EASY requires ca. 40 m<sup>2</sup> are required.

The tent has all the features of the current TOUR EASY 4 (Art. 936550), but in addition to the recycled tent fabric in the roof, it has a black inner coating to reduce the incidence of sunlight and thus also the temperature inside the tent.

**Dims.:** W 300 x D 270+90 x H 180-200 cm

**Pack size:** ca. Ø 25 x 80 cm / weight: ca. 14 kg

**Scope of delivery:** Tent skin, 2 fiberglass poles, 2 pitching poles, 1 airlock pole, guy ropes, pegs, stuff sack **9365503 322,-**

**Optional Inner tent 936558 48,95**

**Optional Tent floor 9365581 29,95**

**Spare rod fiberglass 9365582 9,95**



Inner tent

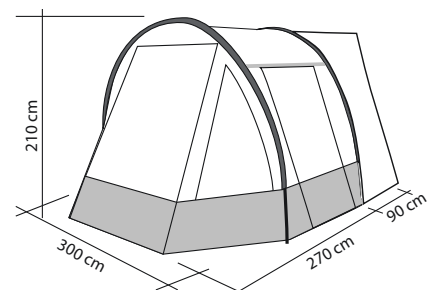

**RE-TENT**  
You can find more models  
from our RE-TENT  
series on PAGE 31

Piping Ø 5+8 mm	185T 68D recycled Polyester	3.000 mm	Seams sealed	Fiber/Alu Ø19/22mm
UV protection	Flame retardant	ca. 14,2 kg	ca. Ø 25 x 80 cm	





Mounting height: 180 - 200 cm



### TOUR EASY YOUNG 2 - Bus awning at the best price

- Large front and side door can be rolled up or used as an awning
- Side windows with 1/2 mosquito net and 1/2 transparent PVC
- Side window in front with inner cover
- Large D-shape door in rear wall

The entry-level model for campers. 1-tunnel awning for vans with a large door in front, which can also be used as sun awning. In both sides window with 1/2 mosquito net and 1/2 transparent PVC. Additional door in right-hand side wall (can also be used as awning), D-shape door in rear wall (can be opened on one side) & airlock (45 cm).

Incl. 3 roof reinforcement rods for more stability and to prevent water pockets when it rains.

**Vehicle connections:** Piping Ø 5 + 8 mm, lock bar or loops for fixing with tensioning lines

**Scope of delivery:** Tent, 2 fiberglass poles, 2 pitching poles, 3 roof reinforcement poles, 1 airlock pole, guy ropes, pegs, carrying bag

**Tour Easy Young 2 - piping length 264 cm**  
936556 219,-

**Optional Inner tent** 9365561 39,95

**Spare linkage** 9365562 19,95

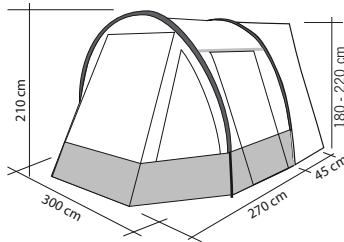

	 185T Polyester	 3.000 mm	 Seams sealed	 Fiber/steel Ø19/22mm
 Piping Ø 5+8 mm	 UV protection	 Flame retardant	 ca. 11 kg	 ca. 67x 22 x20 cm



Mounting height: 180 - 200 cm



### TOUR EASY 4 - Compact awning with high comfort

- Large front with mosquito net
- Lock can be opened on both sides
- Mosquito net in both side walls
- With practical opening for power cable
- Optional inner tent and floor available

The Tour Easy 4 offers a high level of comfort and impresses with the following features: The front has an additional mosquito net insert, the windows in the side walls are equipped with 1/3 mosquito net and 2/3 transparent PVC windows with inner cover. A power cable can be routed through a practical opening on the floor fan. The airlock to the vehicle impresses with openings on both sides.

**Vehicle connection:** Piping Ø 5 + 8 mm, lock bar or loops for fixing with tensioning lines

**Scope of delivery:** Tent, 2 fiberglass poles, 2 pitching poles, 3 roof reinforcement poles, 1 airlock pole, tensioning ropes, pegs, carrying bag

**Tour Easy 4 - piping length 264 cm**  
936550 299,-

**Optional Inner tent** 936558 48,95

**Optional Tent floor** 9365581 29,95

**Spare rod fiberglass** 9365582 9,95

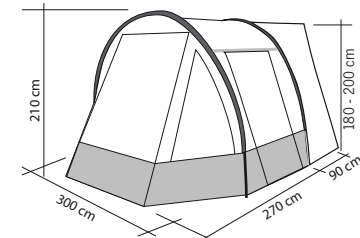

	 185T Polyester	 3.000 mm	 Seams sealed	 Fiber/Alu Ø19/22mm
 Piping Ø 5+8 mm	 UV protection	 Flame retardant	 ca. 14,2 kg	 ca. Ø 25 x 80 cm





# TOUR ACTION 7



**370,-**



Inner tent



Mounting height:  
180 - 200 cm



## TOUR ACTION 7 - Top-equipped, spacious and free-standing bus awning

- Optional hook-in groundsheet & inner tent available
- Both side windows with 2/3 transparent PVC + 1/3 mosquito net - with outer cover
- Bottom ventilation on both sides and 2 top vents in the front
- 90cm airlock with doors on both sides
- Large front door that can be rolled up or used as an awning
- Door in rear wall can be rolled up on both sides, with 1/3 mosquito net
- Roof poles for more stability prevent water pockets in the rain
- Concealed zippers
- Front with 2 side transparent windows with inner cover

**Scope of delivery:** Tent skin, 3 fiberglass poles, 3 roof reinforcement poles (steel), 1 airlock pole (steel), 2 pitching poles (steel), pegs (steel), guy ropes, packing bag  
**900784 370,-**

**Optional inner tent:** Enables 2 add. sleeping places in awning, dims.: W 140 x L200 cm  
**900786 39,-**

**Optional, hook-in Tent floor**  
**900785 19,50**



Floor ventilation



Very spacious

**Attachment to the vehicle:**

- Double piping Ø 5+8 mm
- Locking bar
- Anchor loops

75D-190T polyester

3.000 mm

Seams sealed

Steel/Fiber Ø19/11 mm

UV protection

Flame retardant

ca. 19 kg

ca. 75 x 26 x 37 cm

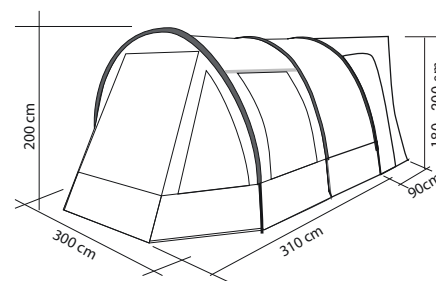





Mounting height: 180 - 200 cm



## TOUR EASY AIR



### TOUR EASY AIR - Air awning for camper vans

- Air technology
- Large front door with mosquito net
- Small pack size, low weight
- Vehicle airlock with doors on both sides
- Practical opening for power cable
- Optional tent floor

The classic: 1-tunnel awning now with air technology. The large front door is additionally equipped with mosquito netting. Additional door in the side wall with 1/3 mosquito net and 2/3 transparent PVC film. The front door and side door can also be set up as an awning.

90 cm airlock to the vehicle (can be opened on both sides) with doors on both sides, floor ventilation, mosquito net in rear wall

#### Vehicle connection:

Piping Ø 5+8 mm. Lock rod + loops for fixation with tensioning lines or suction cups.

#### Scope of delivery: T

ent with 2 air tubes, 2 pitching poles, 3 roof reinforcement poles, 1 airlock pole, guy ropes, pegs, air pump, carrying bag

#### Tour Easy Air - piping length 264 cm

	936559	529,-
Optional Inner tent	936558	48,95
Optional Tent floor	9365591	24,95
Spare air tube	9365592	49,95

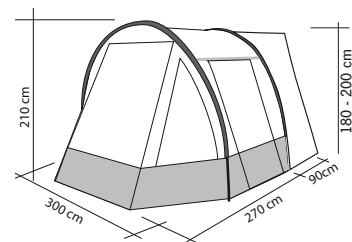

185T Polyester	3.000 mm	Seams sealed	Airtube
Piping Ø 5+8 mm	UV protection	Flame retardant	ca. 14 kg ca. 80x38 x35 cm

#### Optional awning carpet for all Tour Easy awnings

Waterproof underside (PEVA) and soft upper side (fleece) for a pleasantly soft feel and protection against cold feet. Protects the tent floor and is easy to clean (not washable), incl. carrying bag  
936547 44,95



#### Air mattress for 2 people

Suitable for most inner tents. With built-in foot pump, can also be inflated with an air pump. Soft surface made of 210 T polyester ripstop with TPU. Dimensions: W138 x L200 x H10 cm  
Weight: 1.8 kg  
Pack size: Ø 18 x ca. 43 cm  
930881 69,95







Mounting height  
175 - 200 cm



**NEWBURG 160 AIR -  
Inflatable awning**

- Ea sewn-in groundsheet keeps out draughts, insects & dirt as well as possible
- Strategically well-placed rails make it possible to attach special hooks with a carrying weight of up to 1.5 kg
- The double piping offers a suitable option for all motorhome awning strips
- Maximum pressure 9 PSI/0.6 Bar

Newburg 160 Air is very spacious despite its compact size. The living area with its large tinted windows provides a light-flooded interior. Roll-up curtains with fixed suspension points protect against prying eyes if required. The airlock area with its two side entrances can also be used as living space with the floor tarpaulin supplied. The fully opening front is equipped with a mosquito net and is protected by a canopy.

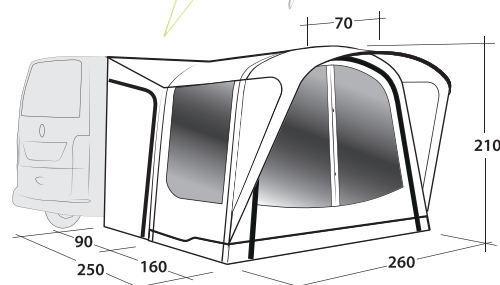

**Scope of delivery:** Tent skin, air tube, groundsheet (PE), pegs, guy ropes, packing bag.

**Newburg 160 Air      9000948      1029,-**

**Accessories for Outwell tents with HookTrack system:**



**Tent Hanging System:** Scope of delivery: 3 adjustable cords (length 2.5 m), 3 hooks & 2 small carabiners in a bag. Weight 116 g

**919270      16,95**



**Accessory Hooks:** 4 pieces, material aluminum, weight 40 g

**919271      8,95**



**Hooktrack Hook:** 10 pieces, material plastic, load capacity 1.5 kg, weight 58 g

**919272      27,95**







# TROUPER AUTO-UP



Mounting height  
180-240 cm



689,-

## TROUPER AUTO-UP Bus awning with dome roof

- Automatic inflation thanks to integrated electric pump with rechargeable battery
- Quick and easy to assemble
- Connection with awning tube

The TROUPER Auto-Up bus awnings are the natural evolution of A.I.R.Tech technology and enable assembly, inflation and anchoring to be carried out in just a few minutes and in absolute comfort. At the same time, there is no need to use traditional metal or fiberglass rods.

### Equipment:

Coating (PU), seam sealing outer tent, ventilation opening  
Adjustable anchor points, Number of entrances (2), Panorama window, Sewn-in groundsheet

**Dimensions:** ca. W 310 x L 260 x H 230 cm

**Pack size:** ca. 80 cm x Ø 35 cm

903737

689,-

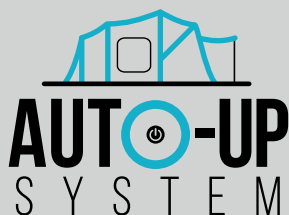
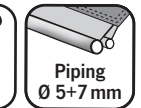
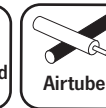
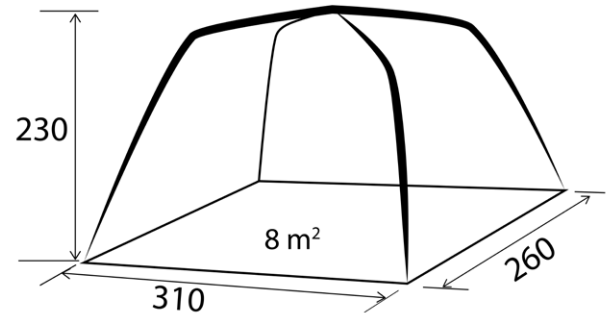

## THE FUTURE IS HERE

Discover the future of outdoor convenience with the revolutionary A.I.S. integrated inflating system. Designed for tents, awnings, and gazebos equipped with air frames, this cutting-edge technology revolutionizes the setup process. With A.I.S., you can say goodbye to the hassle of carrying hand air pumps or electric compressors. Effortlessly inflate your shelter in no time, ensuring a quick and comfortable setup experience. Powered by a rechargeable LiOn battery, A.I.S. provides reliable performance without the need for external power sources. Enjoy the convenience and ease of use that A.I.S. brings, making your outdoor adventures even more enjoyable.





# TOUR BREEZE AIR



Photo shows size S



Spacious interior



All windows and doors with mosquito nets



Freestanding, easy to move away when tent is left standing

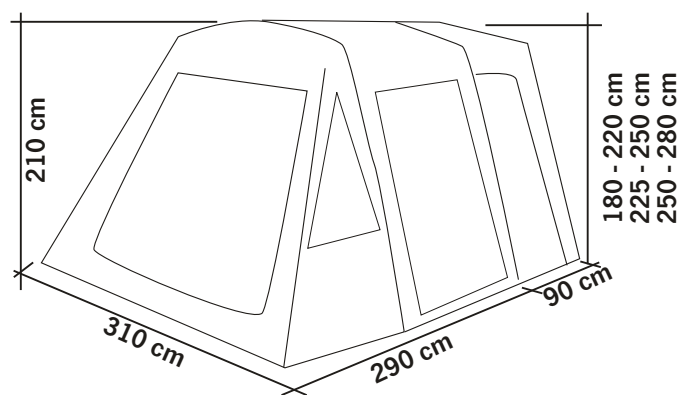

ca. 21 kg	ca. 82 x 30 x 40 cm
-----------	---------------------

Piping Ø 5+8 mm	150D Oxford polyester	UV protection	3.000 mm	Flame retardant	Airtube
-----------------	-----------------------	---------------	----------	-----------------	---------





# TOUR BREEZE AIR



from **569,-**

Photo shows size M



3 mounting heights:

180 - 220 cm

225 - 250 cm

250 - 280 cm



## TOUR BREEZE AIR S, M & L -

Freestanding awning in 3 heights

- Perfectly ventilated awning
- Heavy premium quality
- Keder connection with zipper for easy removal if the tent is left standing
- Freestanding
- Transparent windows with extra large mosquito net inserts
- Front door can be used as an awning
- Sewn-in PVC tent floor
- Including storm bracing and air pump
- Available in 3 heights

Easy and quick to erect air bus awning. The transparent windows in the front and side are equipped with large mosquito nets for optimum ventilation and an external cover.

The rear wall of the airlock is also equipped with mosquito nets and can be opened completely or on one side.

**Scope of delivery:** Tent with air tube, tent floor, 3x roof reinforcement air tube, airlock pole, pitching poles, air pump, tensioning ropes, storm ropes, pegs, stuff sack.

Piping length for all sizes 270 cm

Size S: mounting height 180 - 220 cm

936551

569,-

Size M: Mounting height 225 - 250 cm

936552

599,-

Size L: mounting height 250 - 280 cm

936553

649,-

Spare hoses

Tent: 936554 42,-

Roof reinforcement: 936555 12,75



Photo shows size L



Quick and easy separation and connection of the vehicle thanks to the piping with zipper





# ONE BEAM AIR HIGH



Mounting height:

250 - 280 cm



## ONE BEAM AIR HIGH

Only one air hose for quick assembly!

- Large windows with privacy screen
- Front fully equipped with mosquito net and roll-up covers inside and outside
- New air technology with just one air hose for fast assembly
- Side panels have suction cups for attaching to the vehicle
- Includes practical carrying bag and air pump
- Vehicle bindings with double piping Ø 5 + 7 mm or loops for fixing with tensioning lines or suction cups.

The motorhome awning with just one air hose with external valve. Side walls with doors and windows with curtains provide maximum privacy. Floor as a "frame" under air hoses for quick assembly.

Color: gray, anthracite, lime.

**Scope of delivery:** Tent with air tube, pegs, pitching poles, guy ropes, air pump, carrying bag, groundsheet.

Piping length 400 cm

935394 459,-

Spare tube 9353941 59,99

Suction cups, 6 pieces 935396 9,99

Window with mosquito net

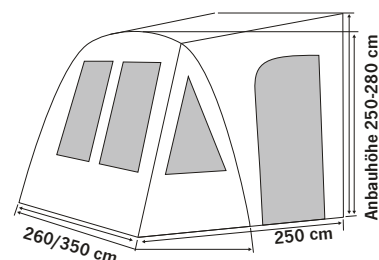
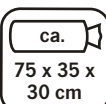





# MARINA AIR HIGH 330 & 390



from **999,-**

Marina Air High 390

Mounting height: 260 - 280 cm

## MARINA AIR HIGH 330 & 390

- One-point inflation system
- High-quality premium material
- Front panels completely removable
- Side walls with mosquito net
- Double-stroke air pump included

Marina Air High motorhome air awnings in classic design with just one air hose for quick assembly & disassembly in premium quality. The front with 2 or 3 large windows has large transparent PVC windows with inner cover and can be completely removed or used as a sun awning. The side walls have a door and a mosquito net window with cover on the outside. There are 2 or 3 skylights with internal covers in the roof.

**Scope of delivery:** Tent skin with 3/4 air tubes, 2/3 reinforcement poles, 2 pitching poles, ladder guy ropes, pegs, guy ropes, air pump, carrying bag

Awning fastening see page 96



All fronts removable

Marina Air High 330

Model	ca.	ca.	Item no.	Price
Marina Air High 330	26 kg	80 x50 x 40 cm	93822	999,-
Spare hose Marina Air High 330			E938220	175,-
Marina Air High 390	28 kg	80 x50 x45 cm	93823	1099,-
Spare hose Marina Air High 390			E938221	190,-

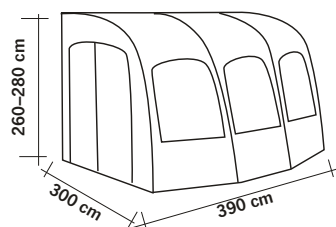
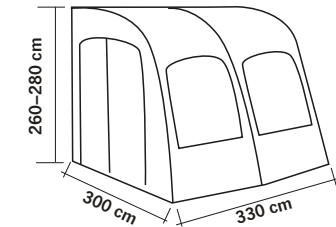

Large transparent window with mosquito net

Attachment to the vehicle:

- Double piping Ø 6+8 mm
- Anchor loops

- 300D Oxford Polyester
- 3.000 mm
- Flame retardant
- UV protection on 50+
- Airtube





# CASA AIR 2 - 390



799,-



**Included** foam bead and support pole for secure attachment to the motorhome

**Mounting height:** 260 - 280 cm

## CASA AIR 2 - 390

- Premium air hoses
- Leasy and quick to set up thanks to 4 separate air hoses
- Transparent windows
- The front sections can be rolled up or set up as an awning
- Special stability thanks to combination of air columns and aluminum reinforcement rods
- Including pressure bar and foam bead

The tent is particularly durable thanks to replaceable double air tubes. The front consists of 3 segments with large transparent windows.

The side sections are equipped with mosquito nets for good ventilation.

All windows have an interior cover to protect privacy.

Color: light grey / dark grey

**Scope of delivery:** Tent skin incl. air tubes, air pump, pitching poles, foam bead and pressure poles, reinforcement poles, guy ropes, pegs, packing bag

900035 799,-

**Optional accessories:**

**Tent floor** 9000342 44,95

**Inner tent, 230 x 130 cm** 9000341 52,50

**Spare air tube** 9000344 59,95

① **Air mattress for 2 persons**

With built-in foot pump, can also be inflated with an air pump. Soft surface made of high-quality 210T polyester ripstop with TPU. Dimensions: 138 x 200 x 10 cm

930881 69,95

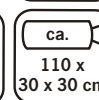
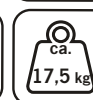
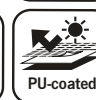
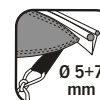
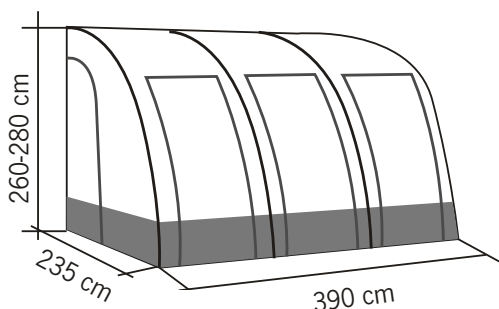





# TOUR PONZA AIR 390



Mounting height: 265 - 295 cm



## TOUR PONZA AIR 390

Freestanding motorhome tent

- Useable as all-season tent
- Single point inflation system
- high-quality TPU air hoses
- Front and side panels with mosquito net and completely removable
- Vehicle connection Ø5+7 mm piping

Stay mobile! The free-standing TOUR PONZA 390 motorhome air awning allows you to drive away with vehicle and leave awning standing. The 3 main vertical and 2 front horizontal roof reinforcement air hoses are connected to each other as a SINGLE INFLATION system. 4 additional horizontal air hoses can be inflated separately and provide stability. The high-quality 300D Oxford Ribstop polyester material also makes this tent suitable as a year-round tent. The front and side sections have transparent windows with external covers & mosquito netting, & can be rolled up or completely removed. The airlock is 80 cm and can be closed by means of a D-shape door (with mosquito net).

Keder length 253 cm 93825 1249,-

**Scope of delivery:** Tent skin, air tube system, 4 x roof reinforcement, storm bracing, air pump, pegs, guy ropes, packing bag  
Pack size: ca. 85 x 55 x 38cm

**Optional accessories:**

Tour Ponza Air 390 groundsheet	938251	49,95
Villa Stripes tent carpet 390x250cm	905171	69,95
Inner tent	938252	69,95
Travel Keder adapter (for easy driving away)	904493	31,50

**Replacement hose:**

Main hose center	E938253	79,95
Main hose left	E938254	79,95
Main hose right	E938255	79,95
Front roof cross hose	E938256	34,95
Rear roof cross hose	E938257	29,95



Freestanding



Inner tent



Freestanding



One-point inflation system

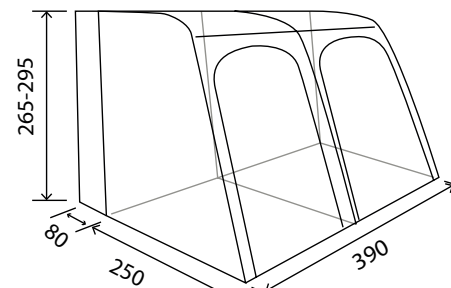

300D Oxford Polyester	Ø 5+7 mm	ca. 27 kg
3.000 mm	Flame retardant	UV protection 50+





from 749,-



### MOVELITE 2 - AIR

Bus awning in 2 heights

- Only one inflation point
- Freestanding
- Tinted windows with curtains
- Optional awning possible
- Sewn-in tent floor
- Including storm bracing
- 5 and 7 mm piping connection

Coach awning with many practical features such as tinted windows, fully opening front, side inflatable canopy, doors in the airlock, sewn-in floor & curtains. The doors are also fitted with mosquito nets.

**Scope of delivery:** Tent with air tubes, air pump, tensioning & storm ropes, pegs, packaging bag.

Mounting height 180 to 220 cm  
**Lowline** 936931 749,-

Mounting height 220-255 cm  
**Midline** 936932 769,-

**Optional inner tent**  
 936934 69,95

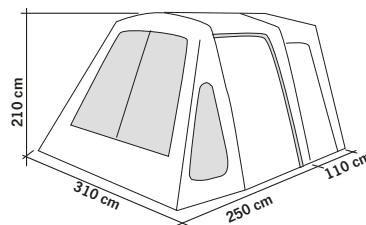

Piping Ø 5+7 mm	480HDE RipStop	UV protection	6.000 mm	2 x Airtube	ca. 19,2 kg	ca. 82 x 47 x 39 cm
-----------------	----------------	---------------	----------	-------------	-------------	---------------------

**Optional groundsheet Footprint**  
 Robust & stable groundsheet for protecting the tent floor from dirt & sharp stones.  
 936935 24,95



**Optional tent carpet** Light and soft tent carpet with thermal foil on the back. 2 waterproof doormats at the entrances. For indoors and outdoors 2,8 x 2,45 m 937991 99,-



from 950,-



2 mounting heights:  
 180 - 240 cm  
 240 - 290 cm



### MOVELITE 3 VARIO

Coach awning with variable door

- Freestanding
- Variable door, can be used as a veranda or front door
- Quick and easy to set up thanks to air hoses
- Side inflatable canopy
- Sewn-in tent floor

The Vario front door can be opened completely & moved inwards to create an open veranda area. Tinted windows, doors in the airlock, a sewn-in floor & curtains are further highlights of this tent. The doors are fitted with mosquito nets. An additional air hose in the roof provides more stability.

**Scope of delivery:** Tent with air tubes, air pump, guy ropes, storm ropes, pegs, packaging bag.

Mounting height 180-240 cm

**Lowline** 936936 950,-

Mounting height 240-290 cm

**Highline** 936937 999,-

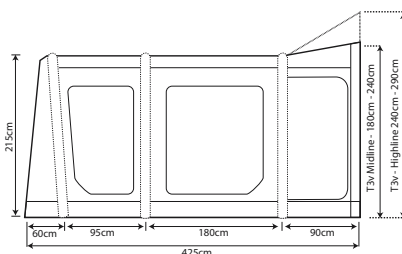

Attachment to the vehicle: • Double piping Ø 5+7 mm	250HD RipStop Polyester	UV protection	4.000 mm
	3 x Airtube	ca. 29,3 kg	ca. 78 x 47 x 47 cm

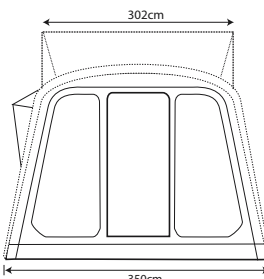

① **Optional tent carpet Snug Rug**

Lightweight, soft awning carpet 936938 139,96

**Footprint groundsheet** 936939 39,95







180 - 210 cm



**MOVELITE 4 -  
Body lengthwise to vehicle**

- Free-standing, inflatable tent
- Side inflatable canopy
- Reflective storm bracing
- Sewn-in tent floor
- Air pump included

Bus awning standing parallel to the vehicle with tinted windows, fully opening front, doors on both sides of the airlock, sewn-in floor & curtains. The doors are also fitted with mosquito nets.

**Color:** Graphite/Ivory

**Scope of delivery:** Tent with air tubes, air pump, guy ropes, storm ropes, pegs, packaging bag.

Model 2018: mounting height 180-210 cm  
**936941 1049,-**

**Optional accessories:**

**Footprint groundsheet**, protects against dirt & sharp stones  
**936944 39,95**



Photo shows 2018 model

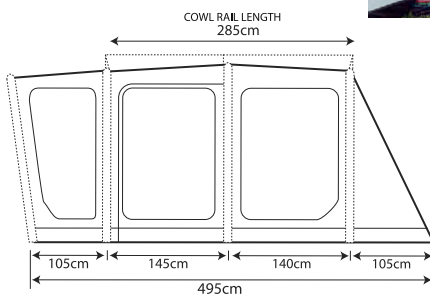
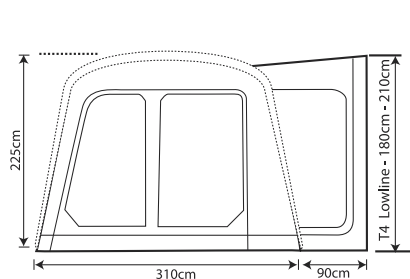

UV protection	4.000 mm	250HD RipStop Polyester	Double piping 5+7 mm
ca. 29 kg	ca. 80 x 50 x 50 cm	3 x Airtube	

**MOVELITE Awning  
suitable for MOVELITE 2, 3 AND 4**

- Connection to Movelite awnings via zipper
- Steel support pole

An ideal addition for Movelite 1, 2 or 3, easily attached to the awning with a zipper. Protects against sun and rain.

**Scope of delivery:** Awning W 310 x D 180 cm, steel pole, guy ropes, storm ropes and pegs.

**936933 99,95**



480HD RipStop Polyester	UV protection	ca. cm T 180 B 190	ca. 4,9 kg	Steel	ca. 76x 27 x 25 cm
-------------------------	---------------	--------------------	------------	-------	--------------------





Mounting height: 250 - 265 cm



### SPORTLITE AIR 320

- Also suitable for caravans
- Spacious living area with extension option (optionally available)
- 280 HDE fabric: high-density, weatherproof, lightweight
- Dynamic, intelligent pressure relief valve system
- Single inflation (single inflation point)
- Front panels can be zipped off
- Zip off left and right side doors with mesh inserts
- Transparent PVC windows
- Adjustable webbing tensioning system

Lightweight caravan/motorhome air awning. The new Single Inflation Technology makes it possible to connect sections of the air frame and then isolate them with airlock valves. This ground-breaking system offers absolute ease by in- and deflation and gives you peace of mind that every part of the structure can be isolated from the other parts of the air frame.

**Scope of delivery:** Tent with air tubes, pump, wind screen, pegs, guy ropes, storm bracing and carry bag.

**Sportlite Air 320**      900055      1130,-

**Optional accessories:**

Extension (L 225 x H 180cm)	900056	399,-
Inner tent	900029	119,-
Air-conditioned ceiling	900057	48,95
Pressure rods (2pcs.)	9000062	30,-

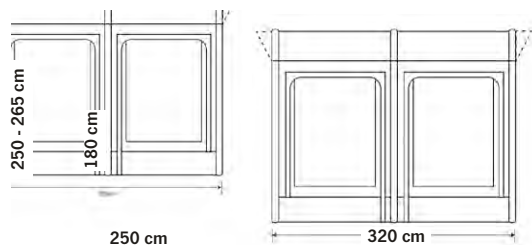

Piping Ø 5+7 mm	280 HD all weather fabric	Breathable	Seams sealed	4.000 mm	Airtube	ca. 20 kg	ca. 83 x 50 x 41 cm
-----------------	---------------------------	------------	--------------	----------	---------	-----------	---------------------



Mounting height: 220 - 290 cm



### ESPRIT PRO X 350 M Free-standing motorhome awning

- Pro 600HD premium fabric for durability and weather protection
- Oxygen air frame with dynamic & intelligent pressure relief valve system
- Single inflation
- Integrated front canopy
- Dfull-length zipper door with zipper at the back left (Phoenix Mesh Panel)
- Sside doors with mesh inserts
- Option for left or right mounting
- Gtinted, anti-reflective PVC windows

Single inflation - this new technology makes it possible to connect sections of air frame & then isolate them with airlock valves. This offers absolute ease of inflation & deflation & gives you the peace of mind that every part of the structure can be isolated from the other parts of the air frame. Length of piping strip: 460 cm.

Dims.: W 350 x D 350 x H 220-290

**Scope of delivery:** Pump, pegs, guy ropes, storm guy ropes and carrying bag.

Esprit Pro X 350 M tent	900051	1750,-
Extension	900052	869,-
Air-conditioned ceiling	900053	38,95
Inner tent	900029	119,-
Tent carpet	900054	33,95

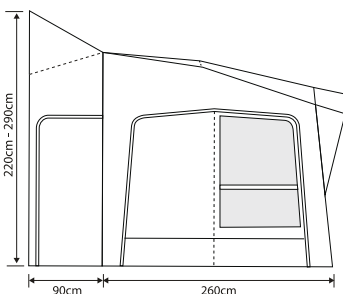

Piping Ø 4+6 mm	6.000 mm	UV protection	ca. 39 kg	Pro 600HD Premium/Fabric	ca. 83 x 59 x 47 cm
-----------------	----------	---------------	-----------	--------------------------	---------------------



**Inflatable windbreak suitable for camper vans**

- protects against draughts
- no piping necessary

Simply place under the vehicle and inflate (pump not included)

**Material:** Heavy duty PVC

**Scope of delivery:** Windbreak, sewn-on tarpaulin w/ eyelets, pegs, carrying bag

**Dims.:** Length 250 cm Ø 30 cm

**Weight:** ca. 3.2 kg

**Pack size:** ca. 45 x 14 x 12 cm

905991 129,-



**12 V electric high-pressure air pump**

Suitable for boats, air tents, mattresses, inflatable furniture, etc.

930681 59,99



**Motorhome protective covers**

- Reliable, water repellent weather protection
- Roof made of breathable material in white for optimum UV protection
- Good ventilation, reduction of mold risk
- Made of tear-resistant 3-ply SFS fabric: roof 125 g/m<sup>2</sup>, Sides 100 g/m<sup>2</sup>

Breathable and weatherproof protective cover preserves value of your motorhome. The side wall is easy to open with a zipper and provides access to the motorhome.

(length is measured at bottom)

L 500 - 550 x W 240 x H 270 cm	928091	239,-
L 550 - 600 x W 240 x H 270 cm	928092	255,-
L 600 - 650 x W 240 x H 270 cm	928093	265,-
L 650 - 700 x W 240 x H 270 cm	928094	279,-
L 700 - 750 x W 240 x H 270 cm	928095	294,-
L 750 - 800 x W 240 x H 270 cm	928096	282,-



**Motorhome cover "Cover Premium"**

Complete protection for your motorhome

- Protects against sun & UV rays
- Highly recommended for longer downtimes

Durable and air-permeable, prevents condensation, integrated zippers allow access to the cab with eyelets for tensioning.



**Cover Premium M** for motorhomes up to 7.1 m, dims.: L: 7.16 x W: 2.59 x H: 2.74 m **92833 489,-**

**Cover Premium L** for motorhomes up to 8.0 m, dims.: L: 8.08 x W: 2.59 x H: 2.74 m **92834 519,-**



**Cover Top tarpaulin**

- Protection from dirt, sun, snow and ice
- Maintaining the value of the vehicle
- Made from UV-stable linen vinyl
- With eyelets for a secure hold

Simply place over the vehicle and tension (supplied without tensioning ropes). Reinforced eyelets every 40 cm for a secure hold. Dimensions: 850x520 cm

42060 168,-





# WALLABY 2



Suitable roof racks can be found on 502 Suitable roof tent heaters on page 930

Mounting on vehicles equipped with base carriers. Please take the maximum roof load of the vehicle into account.

**1299,-**



## WALLABY 2 - Softcover roof tent

- Practical roof tent for cars, vans and SUVs
- With weatherproof roof
- Includes mattress, breathable mesh base and aluminum ladder
- 2-3 sleeping places
- Utensil pockets on the side
- PVC tarpaulin protects during the journey

The classic roof tent for 2-3 people is suitable for cars, vans or SUVs. The equipment includes openings on all 4 sides with mosquito net inserts to protect against mosquitoes and other insects and for optimum ventilation. All openings can be set up with 2 tension rods each. The underbody is made of insulated aluminum plates and can be folded in the middle. A telescopic ladder is also incl. in scope of delivery. Roof is weatherproof and protects against rain and moisture, the comfortable 7 cm thick mattress lies on a 3D mesh base, which provides ventilation and prevents mold growth, for example. Inside there are several side pockets for storing items such as cell phones, glasses, etc.

**Material:** Tent: 280 g/m<sup>2</sup> Rip stop canvas / canopy: 200D polyester (weatherproof), tarpaulin: 1000 D PVC (waterproof)

### Dimensions:

Open L 240 x W 140 x H 130 cm / Closed L 120 x W 140 x H 30 cm  
 Sleeping surface: 230 x 135 cm / Weight: ca. 55 kg  
 Load capacity: roof tent: 300 kg / ladder: 150 kg

**Scope of delivery:** Roof tent, telescopic ladder 200 cm (aluminum), mattress (cover removable and washable), 3D mattress pad, fastening material, 8 tensioning poles, tarpaulin

(Note: distance between the mounting rails is 80 cm)

**Wallaby 2 roof tent** **900633** **1299,-**

### Optional accessories:

<b>Roof tent Ext.</b> ① W 120/150 x D 140/230 x H 180cm	<b>9006331</b>	<b>179,-</b>
<b>Thermo Cover</b> (not shown)	<b>9006332</b>	<b>149,-</b>
<b>Ladder extension</b> 54 cm ②	<b>900631</b>	<b>54,95</b>
<b>Storage net Wallaby</b> ③		
L 90 x W 60cm, color: black, weight: ca. 1.1 kg (see photo ③)	<b>9006334</b>	<b>59,95</b>
<b>Shoe bag Wallaby</b> (not shown)	<b>9006333</b>	<b>29,95</b>

**Froli - Sleeping system for Wallaby (Art. no 590248)** can be found on page 545

Tent:	Hood:	Tarpaulin:





# VICTORIA 2.0



1699,-

Suitable roof racks can be found on page 502 Suitable roof tent heaters on page 930

Mounting on vehicles equipped with base carriers. Please take the maximum roof load of the vehicle into account.



## VICTORIA 2.0 - Folding tent with covered entrance

- Ready for use in a few simple steps
- Weatherproof
- For cars, vans and SUVs
- 1-2 sleeping places
- PVC tarpaulin protects during the journey
- Including mattress and aluminum ladder
- Hook in the roof for e.g. light
- With 2 shoe pockets at the entrance, storage bag inside

Roof tent in a new design for manual opening - suitable for cars, vans and SUVs. The roof tent is quickly unfolded. It is equipped with mosquito nets in all openings (3 sides), 2 practical shoe pockets at the outside entrance, a 7 cm thick comfortable mattress and an aluminum telescopic ladder. The underbody consists of a sturdy aluminum frame.

**Material:** Tent: 220 g/m<sup>2</sup> Polyester (PU coated), roof 200D polyester (weatherproof), tarpaulin: PVC (waterproof)

**Dims.:** Opened L 212 x W 132 x H 102 cm,

Closed L 107 x W 132 x H 25 cm

Sleeping surface 200 x 115 cm

Weight: ca. 50 kg (including ladder)

Load capacity: roof tent: 250 kg / ladder: 150 kg

Color (tent and tarpaulin): Grey

**Scope of delivery:** Roof tent with aluminum frame, telescopic ladder (aluminum), mattress (cover removable and washable), fastening material, tarpaulin

Victoria roof tent **900647** **1699,-**

**Optional for VICTORIA 2.0: roof tent att. ①**

Connection to VICTORIA 2.0 roof tent via zipper / ladder inside the extension protects against rain, wind & cold

**9006471** **499,-**



Tent:	Hood:	Tarpaulin:
Polyester 220g/m <sup>2</sup>	PU-coated	ca. 250 kg
200 D Polyester	100% PVC	4.000 mm

### Optional accessories for all roof tents:

#### Car door step with folding hook ②:

- Facilitates the opening & closing of roof tents
- For easy access to the vehicle roof
- Ideal for loading or cleaning the vehicle roof
- Loadable up to ca. 120 kg

Material: Metal, powder-coated. With rubber lip to protect vehicle paintwork. Color: black, dims.: LxWxH 16.1 x 7.6 x 1.6/8.4 cm, weight: 0.3 kg.

**900060** **14,95**







# BENDIGO AIR



1799,-

Mounting on vehicles equipped with base carriers. Please take the maximum roof load of the vehicle into account.



## BENDIGO AIR - Air roof tent including platform

- Large sleeping area for 2 people (L 220 x B 140 cm)
- 2 doors and 2 windows with canopy
- Mosquito net on all openings
- For cars, vans, SUV's
- Tarpaulin protects during the journey
- Roof lining for more comfort
- Small pack size

The roof tent with inflatable mattress and 1 air tube is supplied with an aluminum roof platform. This is mounted on the vehicle in order to the inflated mattress into the rail of the platform using piping ①. The tent skin is fixed to the mattress and can then simply be inflated using the pump supplied. This is done very quickly thanks to one-point inflation system ③ After fixing the ladder, the roof tent is ready for use. Deflation is very quick thanks to the 2 valves, the tent and inflated mattress can remain on the platform and are protected by a tarpaulin during the journey. The roof tent and mattress can be quickly and easily removed from the platform and stowed in the carrying bag (ca. 90 x 55 x 43 cm), giving you the choice of leaving the roof tent on the roof while driving or stowing it in the vehicle. All windows and doors are fitted with mosquito nets and have a canopy that can be set up quickly. The scope of delivery includes tension rods for all windows/doors, a headliner that creates a cozy atmosphere and reduces condensation ② as well as a mattress topper for more comfort. Additional guy loops are provided at the corners of the roof tent. The roof tent can also be used without a platform and vehicle on the ground.

**Load cap.** Ladder: max. 150 kg / platform: 250 kg

**Material tarpaulin:** 600D Oxford + coated PVC (weatherproof)

**Tent skin:** Color: anthracite/light grey,

**Material:** 210D rip-stop polyester with one-point inflation system, weight ca. 8 kg

**Mattress:** Color: light grey, L 220 x W 140 x H 10 cm (polyester), weight ca. 12.5 kg

**Roof platform:** L 220 x W 140cm (aluminum), weight ca. 18 kg

**Platform:** L 194 x W 121cm (5 cross struts, 2 longitudinal struts 52 cm apart), max. load 250 kg / height closed ca. 25 cm

**Ladder:** W 45 cm x L 71-233 cm (aluminum), weight ca. 5.7 kg

**Overall dimensions:** L 220 x W 140 x H 115 cm, weight ca. 51 kg

**Scope of delivery:** Roof platform, tent skin incl. air hose, inflatable mattress, mattress pad, telescopic ladder, tarpaulin, roof lining, hand pump, electric pump, pegs, window tensioning poles, panniers, fastening material

900629

1799,-

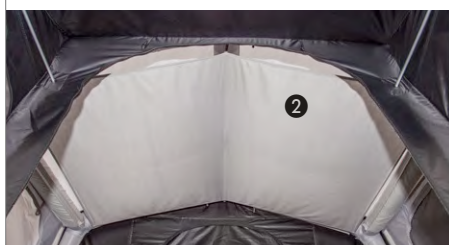

Tent:

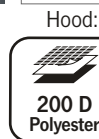

Hood:

Tarpaulin:

### Optional accessories:

#### ① Thermocover for Bendigo Air

Provides warmth in cold weather. Easy to install inside the roof tent using clips. Quickly removable. Supplied in a pack sack. Weight: ca. 2.5 kg

9006291

129,-

Optional awning : CHARLY - Art.nr. 90066 (page 30)





**GENTLE TENT**  
COMING HOME

# GT ROOF II

# GT ROOF MINI II

**NEW**



from **2689,-**



## GT ROOF MINI II + GT ROOF II - Air roof tents

- Space-saving pack size, lightweight & compatible
- Extremely storm-resistant thanks to high-pressure hoses throughout tent
- Two-layer construction for optimum indoor climate in all weathers
- Windows combined with mosquito nets

Material: TC 200C 65/45 (inner tent), PES 210g PU (outer cover)  
Colors: Anthracite / Ivory with yellow highlights

### ① GT ROOF MINI II - feather-light luxury roof tent

- Bed surface 125 x 200 cm for 2 persons
- Interior height 150 cm
- Very small pack size

External dims.: 325 cm x 144 cm x 173 cm  
Lying surface: 125 x 200 cm, Weight: 29 kg, Required roof load: min. 40 kg  
Pack size (L x W x H) 148 x 77 x 24 cm  
Scope of delivery: 1x telescopic ladder, assembly kit, repair kit & 12V pump

- |                          |               |               |
|--------------------------|---------------|---------------|
|                          | <b>900680</b> | <b>2689,-</b> |
| ② GT ROOF MINI II Nose   | <b>900695</b> | <b>329,-</b>  |
| ③ GT ROOF MINI II Awning | <b>900696</b> | <b>589,-</b>  |

### ④ GT ROOF II - the feel-good roof tent

- Large lying surface 160 x 220 cm for 2-3 people
- Interior height 165 cm
- Optimum climate regulation
- All-round view + view of the stars

External dims.: 325 cm x 174 cm x 186 cm  
Bed surface: 160 x 220 cm. Weight: 43 kg, Required roof load: min. 50 kg  
Pack size (L x W x H) 170 x 120 x 24 cm  
Scope of delivery: 1 x telescopic ladder, 2x support poles, assembly kit, repair kit & 12V pump included.

- |                                 |               |               |
|---------------------------------|---------------|---------------|
| ⑤ GT ROOF II nose (weight 5 kg) | <b>900677</b> | <b>2990,-</b> |
| ⑥ GT ROOF II awning             | <b>900678</b> | <b>349,-</b>  |
| Can be tensioned as sun awning  | <b>900679</b> | <b>629,-</b>  |



## Optional accessories:

### Gentle Tent mattress

an inflatable camping mat with a washable air mesh cover.  
The desired degree of firmness is regulated via air pressure.  
Sleeping surface dims.: L 200 x W 65 x H 7 cm  
Weight: 2 kg, Color: Black  
**900674**

**225,-**







# MOONLIGHT TENT

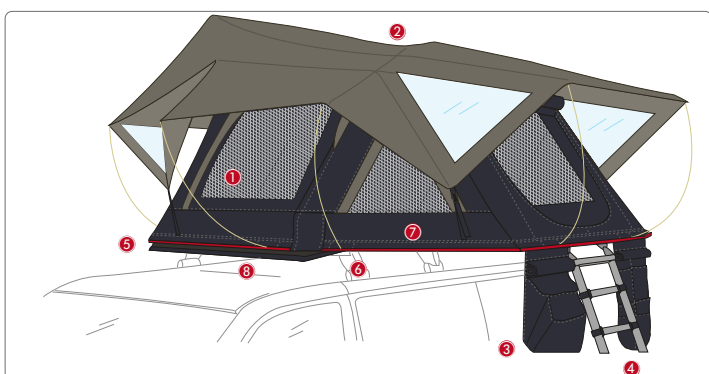

**① Openings**

With fly screen and blackout on all 4 sides

**② Rain protection cover**

With canopies for better protection

**③ Bag**

For tidy storage of accessories

**④ Manager**

Made of aluminum, height 2.3 m

**⑤ Cloth**

Tent: Poly-cotton canvas Cover: Oxford 210D Cover: Oxford 700D

**⑥ Opening**

Foldable, quick and easy

**⑦ Mattress**

5 cm thick made from 2 types of foam of different thicknesses

**⑧ Underbody**

Aluminum panels with honeycomb structure

## Fiamma Moonlight Tent 140 and 180 - Folding tent with covered entrance

Roof tent for vehicles with roof rails

Experience the pinnacle of camping comfort with the Fiamma Moonlight tents. Developed for camper vans, off-road vehicles and vehicles with roof rails, the Moonlight Tent 140 and Moonlight Tent 180 models and their privacy versions offer the ultimate in luxury in the motorhome sector.

- Suitable for roof rails with a load capacity > 75 kg and a usable width of > 78 cm
- Compatible with wall awnings
- Fly screen and blackout on all 4 sides, rain cover with windows
- Closure with zippers from YKK
- With aluminum ladder and waterproof cover
- Internal LED strip with adjustable light intensity

**Scope of delivery:**

Roof tent, rain protection cover with windows, aluminum ladder (2.30 m, load capacity: 150 kg), waterproof cover, LED strips with adjustable light intensity.

**Material:** Poly-cotton canvas, cover made of hard-wearing Oxford material.

Model	ca.	Dimensions open	Dimensions closed	Interior dimensions	Load capacity	Persons	Item no.	Price
Moonlight Tent 140	54 kg	140x240x120 cm	148 x 130 x 27 cm	139 x 238 x 120 cm	500 kg	max. 2	440580	2091,--
Moonlight Tent 180	62 kg	180x240x120 cm	184 x 130 x 27 cm	179 x 238 x 120 cm	500 kg	max. 3	440581	2448,--

**Optional accessory: Privacy Moonlight Tent**

Addition of a multi-purpose changing room to the roof tent for better privacy

	ca.	Height cm	Item no.	Price
Privacy Moonlight Tent 140	4,7 kg	180-220 cm	440582	480,--
Privacy Moonlight Tent 180	5,0 kg	180-220 cm	440583	516,--





# AUTOHOME 4.0



from **4619,-**

## Autohome 4.0 - Rooftop tent with panoramic view

- Classic model with elegant, aerodynamic design
- perfectly mountable also on small cars and all-wheel drive vehicles (4x4)
- Opening by means of a crank handle
- 2 doors and 2 windows plus 4 additional windows for panoramic views
- Dense and darkening fiberglass mosquito net to protect against prying eyes
- New with skylight incl. mosquito net and blackout blind (70 x 60 cm aluminum frame)
- Roof lining with multi-layer insulation for very good noise and heat protection
- Hard shells protect against heat and cold
- Floor soundproofed and well insulated to prevent condensation
- Tent fabric waterproof and resistant, with high water vapor permeability to the outside

### Features:

Mattress made of high-density foam with cotton cover, pillow, storage bags. Incl. telescopic ladder for medium-sized vehicles (Base with "C" profile rails enable simple and reliable clamp mounting on standard luggage carriers with 20 x 30 mm min. profile cross-section)

Height 35 cm



Height 125 cm

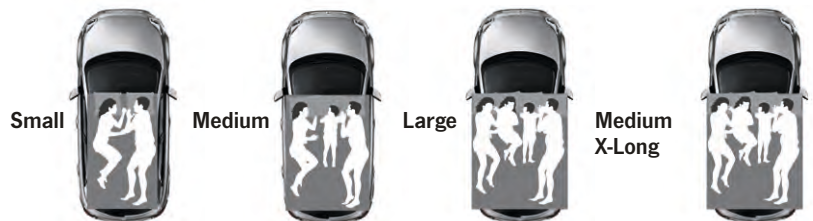

Size	Art. no:	Weight	Volume	Dimensions	Height: closed / open	Price
Small	900684	67 kg	ca. 236 l	130 x 210 cm	35 / 125 cm	4619,-
Medium	900685	73 kg	ca. 260 l	145 x 210 cm	35 / 125 cm	4899,-
Medium X-Long	900686	82 kg	ca. 275 l	145 x 230 cm	35 / 125 cm	5139,-
Long	900687	85 kg	ca. 286 l	165 x 215 cm	35 / 125 cm	5149,-





# AUTOHOME 1.0



You will find suitable roof racks on page 502

from **3279,-**

Fabric: Grey/Shell: White

Fabric: Carbon/Shell: Black



Height 30 cm



Height 92 cm



## AUTOHOME 1.0 - Hard shell roof tent

- Crank opening
- Weight-saving design
- Large interior volume even when closed
- Doors are turned into windows or variable openings with curved hinges
- Aerodynamic design

The Autohome roof tent 1.0 is a classic model with an elegant, aerodynamic design and can also be fitted perfectly on small cars and all-wheel drive vehicles (4 x 4). The "double" roof consists of a fiberglass shell and a synergistically adapted honeycomb-like panel perforated with a special laser. Fiberglass roof does not attract lightning during thunderstorms. The roof shells do not deform in the heat, are UV-resistant and color-stable. Tent material is waterproof, durable & breathable, & protects against heat and cold.

**Scope of delivery:** Roof tent with 4 clamps for attachment to the roof rack, 1 crank handle, condensation-repellent & sound-absorbing interior roof lining, practical storage net, 2 removable hanging bags, 1 mattress, 2 pillows, ceiling lamp for interior lighting, height-adjustable aluminum ladder, carrying bag for ladder.

The X-Long version is suitable for medium and large vehicles (4x4s, minivans, vans, SUVs and estate cars)



Small



Medium



Large

	Fabric: Grey/Shell: White		Fabric: Carbon/Shell: Black		Weight	Volume	Sleeping surface dims
Small	900652	3279,-	900656	3524,-	ca. 66 kg	ca. 196 L	130 x 210 cm
Small X-Long	900597	3548,-	900598	3793,-	ca. 72 kg	ca. 210 L	130 x 230 cm
Medium	900653	3539,-	900657	3779,-	ca. 72 kg	ca. 220 L	145 x 210 cm
Medium X-Long	900654	3779,-	900658	4027,-	ca. 79 kg	ca. 235 L	145 x 230 cm
Large	900655	3925,-	900659	3979,-	ca. 84 kg	ca. 260 L	160 x 215 cm





# AUTOHOME 2.0



You will find suitable roof racks on page 502

from 3465,-

## AUTOHOME 2.0 - Hard shell roof tent

- Automatic opening
- Easy to open, convenient to close
- ventilated roof as anti-condensation
- Interior height of ca. 150 cm (open)
- Mosquito net on all openings
- High-quality fabric, resistance to extreme temperatures
- Large variable entrance at the back

The Autohome 2.0 series is equipped with a self-opening automatic gas spring system. The shells have a clear, flowing, aerodynamic and aesthetically perfect line - even on small vehicles. The tent fabric is a high-quality waterproof fabric, resistant to extreme temperatures (-40°C/+70°C). The roof tent has a suspended ceiling whose air cushions provide excellent thermal and acoustic insulation for a quieter environment. The roof shells do not deform in the heat, are UV-resistant and color-stable. Fiberglass roof does not attract lightning during thunderstorms. The X-Long version is suitable for medium and large vehicles.

**Scope of delivery:** Hard-shell roof tent with 2 gas springs, 4 clamps for attachment to the roof rack, 2 entrances with mosquito net on the side and 1 entrance with mosquito net on the front, mosquito net on all openings, condensation-repellent and sound-absorbing inner canopy, practical storage net, 1 foam mattress, 2 pillows, 1 ceiling lamp, height-adjustable aluminum ladder, carrying bag for ladder, elastic cords.

Fabric: Gray/Shell: White

Fabric: Carbon/Shell: Black



Height 150 cm



Height 30 cm

Small



Medium



Large



	Fabric: Grey/Shell: White		Fabric: Carbon/Shell: Black		Weight	Volume	Sleeping surface dims
Small	900648	3465,-	900688	3705,-	ca. 59 kg	ca. 196 L	130 x 210 cm
Small X-Long	900606	3566,-	900689	3949,-	ca. 64 kg	ca. 210 L	130 x 230 cm
Medium	900602	3759,-	900690	3985,-	ca. 65 kg	ca. 220 L	145 x 210 cm
Medium X-Long	900608	4028,-	900671	4049,-	ca. 71 kg	ca. 235 L	145 x 230 cm
Large	900604	3997,-	900605	4242,-	ca. 77 kg	ca. 260 L	160 x 215 cm





# AUTOHOME 3.0 & OVERLAND



from **2319,-**

Suitable roof racks can be found on page 502

## Autohome 3.0 & Overland Soft-top roof tent with folding system

- Set up in a flash
- Suitable for all vehicles
- Transport cover protects against rain and dirt during the journey
- Equipped with 2 comfortable pockets

Roof tent is a fabric tent with a folding system. The ladder on the base plate allows the tent to be opened quickly and easily. Ladder sliding is prevented by the Automatic Ladder Security System (ALSS). The reinforced aluminum ladder is easy to use and can be extended to a length of 225 cm. Their steel rails allow them to function perfectly even in sand.

The entrances can be opened out and used as awnings. The windows are fitted with eaves, mosquito netting and double rollers and are therefore wind and rain resistant.

The special fabric has properties that also meet strict military requirements. Fabric is thick, hard-wearing and breathable. It doesn't flap or make a noise in the wind or morning breeze, ensuring undisturbed nights and a peaceful awakening. The fabric offers excellent blackout.

**Scope of delivery:** Fabric roof tent incl. 4 clamps for attachment to the roof rack, 2 closable side triangular windows with mosquito net and 2 entrances with mosquito net, 1 foam mattress, 2 pillows, telescopic poles for the open entrances, 1 vinyl transport hood, 1 height-adjustable telescopic aluminum ladder

**AUTOHOME 3.0** Roof color: Grey/  
Fabric color: Carbon

**OVERLAND** Roof color: Grey/Color  
fabric: Carbon



Height  
125 cm



Height  
35 cm



Small



Medium



Large

Fabric: Carbon/roof: Grey	AUTOHOME 3.0		OVERLAND		Weight	Dimensions: open	Dimensions: closed
Small	900681	2319,-	900581	2319,-	ca. 54 kg	130 x 220 cm	130 x 110 cm
Medium	900682	2550,-	900582	2597,-	ca. 63 kg	160 x 220 cm	160 x 110 cm
Large	900683	2750,-	900583	2789,-	ca. 69 kg	180 x 220 cm	180 x 110 cm



## Autohome thermal hoods

- Protects from moisture, wind & cold
- Lightweight and easy to install
- Does not need to be removed when the tent is closed
- Highly recommended in cold winters and when temperatures fluctuate
- Material: PU-coated nylon fabric

### ① For Autohome 1.0 + 4.0:

Small	900620	259,-
Small X-Long	900691	259,-
Medium	900627	259,-
Medium X-Long	900692	259,-
Large	900628	259,-

### ② For Autohome 2.0:

Small	900610	259,-
Small X-Long	900693	259,-
Medium	900613	259,-
Medium X-Long	900694	259,-
Large	900614	259,-

### For Autohome 3.0 + Overland:

Small	900584	289,-
Medium	900585	289,-
Large	900586	289,-



## Changing room cabin Autohome 1.0

Quick option for a protected zone and more privacy. lockable on 4 sides, window with mosquito net

① For cars: H 155-170 cm **900621** 659,-

② For SUVs, vans, off-road vehicles

H 171 - 185 cm	900622	779,-
H 186 - 200 cm	900623	779,-
H 201 - 220 cm	900624	779,-



## Wings Autohome 1.0 - Wings

Protection at the entrances for additional shelter in the rain. They are easy to use. Made of Airtex material, manufactured in aluminum & steel, with wind-resistant structure. Very space-saving when closed.

Scope of delivery: 2 pieces

Color: Carbon **900626** 309,-



## Mattress base for roof tents

The mattress base ensures optimum ventilation under the mattress. The moisture can escape in all directions and almost no condensation forms.

Material: DRYWEAVE - elastic, three-dimensional mesh fabric with over 95% air content, made from PP (450g/m<sup>2</sup>)

Small (120 x 210 cm)	900630	125,-
Medium (140 x 210 cm)	9006301	135,-
Large (160 x 210 cm)	9006302	149,-

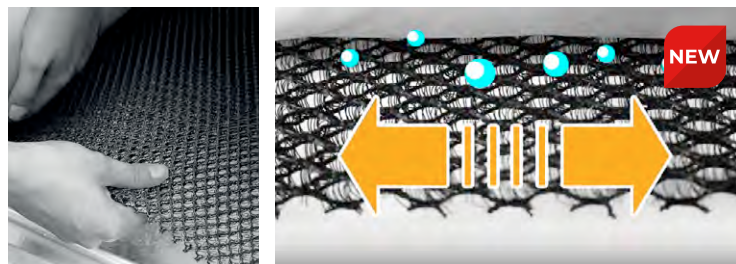

### ① Autohome 2.0 awning

Quick option for a protected zone and better privacy.

Vehicle height 150-185cm **900611** 339,-

Vehicle height 186-240cm **900612** 359,-  
(width 150 cm)

General accessories:

Aluminum ladder 4x4 **900643** 196,-  
up to vehicle height 215 cm (not shown)

② Extra-long aluminum ladder **900644** 196,-  
up to vehicle height 240 cm





# LINOSA AIR



from **319,-**



Photo shows 2 x LINOSA AIR 350, connection and canopy to the vehicle

## LINOSA AIR -

Complete pavilion set in 4 sizes

- Only 1 air hose
- Incl. 4 side panels
- For camping, garden, party, etc.
- Standing height ca. 215 cm, entrance height ca. 170 cm
- Side panels can be ordered separately for optimization according to your wishes
- Side panels are attached with hooks and Velcro
- Roll-up door in side wall with zipper
- Equipped with hooks in the roof, e.g. for lamp

Scope of delivery: 1 pavilion with 1 TPU air tube, air pump, 4 side walls: 2x with mosquito net, 1x closed, 1x with zipper door, pegs, guy ropes, packing bag.

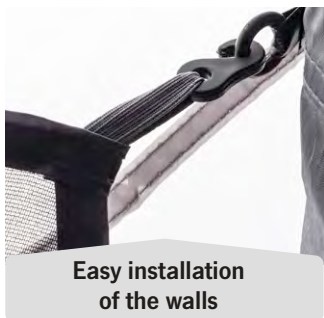

Easy installation of the walls



185T Polyester

UV protection

3.000 mm

Airtube

ca. 75 x 30 x 30 cm



Including 4 side walls: 2x with mosquito net, 1x closed and 1x with door



Only one inflation point!

Model	Size in cm	Weight	Art. no.	Price
LINOSA 250	250 x 250	ca. 9 kg	905576	319,-
LINOSA 300	300 x 300	ca. 10 kg	905577	369,-
LINOSA 350	350 x 350	ca. 11 kg	905578	419,-
LINOSA 400	400 x 400	ca. 12 kg	905579	459,-



Lamp cable can be routed in the air hose cover

Additional accessories	LINOSA 250		LINOSA 300		LINOSA 350		LINOSA 400	
	Item no.	Price	Item no.	Price	Item no.	Price	Item no.	Price
Side panel closed	9055761	17,95	9055771	19,95	9055781	21,95	9055791	23,95
Side panel with door	9055762	21,95	9055772	24,95	9055782	27,95	9055792	29,95
Side wall with mosquito net	9055763	18,95	9055773	19,95	9055783	21,95	9055793	23,95
Spare hose set	9055764	59,95	9055774	64,95	9055784	74,95	9055794	79,95

All items without decoration





**① Connection - LINOSA pavilion**  
**Protection from rain, sun, wind and cold**

- Simple attachment with hooks and Velcro

The fastening options of the side walls are used to create a connection between 2 pavilions. This protects you from rain, sun, wind and cold and extends your pavilion. You can connect an infinite number of pavilions to create a large party location or an oasis of calm.

**Connection for:**

LINOSA 250 pavilion	9055799	29,95
LINOSA 300 pavilion	9055800	32,95
LINOSA 350 pavilion	9055801	34,95
LINOSA 400 pavilion	9055802	37,95

**② Roofing / vehicle connection - LINOSA pavilion**  
**Flexible roofing for the vehicle**

- Suitable for all vehicle heights
- Protects from rain and sun
- Double piping Ø 5+8 mm, lock bar tunnel
- Quick and easy to install

The vehicle connection is a canopy from the pavilion to the vehicle with the possibility of getting into the vehicle dry, e.g. in the rain.

Color: Light grey, Material: Polyester

**Roofing / vehicle connection for:**

LINOSA 250 pavilion	9055795	24,95
LINOSA 300 pavilion	9055796	27,95
LINOSA 350 pavilion	9055797	29,95
LINOSA 400 pavilion	9055798	32,95





TOP  
SELLER



**CAMPALTO -  
Shower/changing tent**

- Removable base
- Quick and easy to set up
- Fastening hooks in the roof e.g. for shower

Protected ventilation opening at the top enables rapid air exchange. Inner pockets for shower gel or similar.

Frame: fiberglass, material: 100% polyester, Water column: 1000 mm.

Dims.: W 150 x D 150 cm, H 210 cm, Pack size: 54 x Ø 12 cm, Weight: ca. 3.0 kg  
**901029 69,95**



TIP

**MALTA -  
Shower/changing tent**

- Quick and easy to set up
- Versatile use, e.g. as a shower tent or changing room

Transparent cover on top, practical storage net inside on the back wall.

Material: 100% polyester PU-coated, poles: fiberglass

Ø 9.5 mm, dims.:

W 165 x D 165 x H 200 cm, pack size: 54 x Ø 12 cm, weight: ca. 3.0 kg

**90108 59,95**



**ALICANTE -  
Kitchen / Equipment tent**

- Can be used as a kitchen, equipment, storage or changing tent
- Robust steel frame
- 3 large windows with mosquito net
- Large roll-up entrance door

Robust kitchen tent, can also be used as equipment tent, storage tent or changing room tent, with large entrance door (can be rolled up to the side), robust steel poles Ø19 mm, large window with mosquito net & outer cover in sides, high ventilation.

Dims.: W 200 x D 190 x H 215 cm, door height 185 cm, door width 85 cm.

Material: 100% polyester (with PVC coating)/ roof: PVC. Pack size: L 105 x W 27 x D 27 cm, weight: ca. 16.5 kg. **901036 219,-**





**DUNE and SYLT -  
Windbreak 500 x 140 cm**

- With 3 elements
- Protection from wind and prying eyes
- For the beach, campsite or garden
- Light weight, small pack size

Inexpensive windbreak with 3 elements without window. Protects from wind and prying eyes, incl. 4 steel poles  
Material: 190T Polyester, Dims.: 500 x 140 cm, Pack size ca. 65 x Ø 12 cm, Weight: ca. 1.5 kg

① Dune windbreak

Color: Grey/Anthracite/Lime-Green

**900515 35,90**

② Sylt windbreak

Color: Grey/Blue

**900514 29,95**



**SMÖGEN -  
Windbreak 500 x 125 cm**

- Quick assembly system
- For the beach, campsite or garden
- 4 elements
- Variably positionable
- suitable for veranda function in front of motorhome, caravan & campervan
- Usuable as wind and privacy protection

**Material:** 150D Oxford polyester Color: Grey

**Dims.:** 500 x 125 cm

**Pack size (L x W x H):** 93 x 15 x 16 cm, weight: 1.5 kg

**Scope of delivery:** Windbreak, poles, guy ropes, pegs, packing bag

**900520 119,-**



W 500 x H 125 cm





# WIND PROTECTION



## Wind and privacy screen, W 500 x H 125 cm

- Simple structure
- Durable Oxford nylon frame channels
- Including pegs and self-luminous guy ropes
- One window per segment

Material: Outtex (100 % polyester taffeta),  
Steel poles Ø 16 cm, pack size: 52 x 12 cm,  
Dims.: 500 x 125 cm, weight: 3.1 kg

① Color: Charcoal Grey	<b>90191</b>	<b>89,95</b>
② Color: Navy Night	<b>901911</b>	<b>89,95</b>



## Flex Grey - Windbreak system 460 x 140 cm

- Flex 3-part windbreak in gray
- Can be extended as required

① **Flex basic model:** 2 end sections with porthole, 1 middle section with window at the top. Incl. Zinox tubular steel poles, tent ropes, windbreak support blocks (ground anchors) & pegs. Material: 100 % polyester, dimensions: W 460 x H 140 cm  
Color: Steel Blue/Grey **935000 346,-**

### Flex extension parts:

Any number of extension parts can be installed.  
Material: 100 % polyester. Dims.: W 154 x H 140 cm

② <b>Closed</b>	<b>935020</b>	<b>132,-</b>
-----------------	---------------	--------------

**346,-**







① HELGOLAND AIR 400 -

**Wind & privacy protection**

- Easy to set up by pumping up, no poles required
- Segments individually inflatable
- Segments can be joined together with a zipper
- Can be extended as required with optional extension segment
- Pump included

The wind and privacy screen with transparent windows consists of 2 segments of 200 cm each and has a comfortable height of 155 cm. By simply inflating the air hoses, the windbreak sets itself up almost automatically. Each segment can be inflated & used individually. All segments can be connected with zippers as required. **Scope of delivery:**

Wind & privacy protection, air pump, pegs, guy ropes, packaging bag  
 Color: Grey/Dark grey      900539      179,-

② HELGOLAND AIR - Extension segment

- Extends the Helgoland Air windbreak by 200 cm

With transparent windows. The inflatable segment is connected with a zipper, so the windbreak can be extended as required.

**Scope of delivery:** Wind protection panel (no pump), pegs, guy ropes, packing bag. Color: Grey/Dark grey      900540      79,95

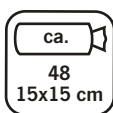
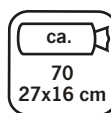
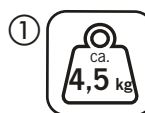

**HOOGE AIR 480 -**

**Wind protection w/ air technology**

- Without poles, easy to set up by inflating
- Only 1 inflation point
- With transparent windows
- 3 segments á 160 cm
- Can be extended as required
- Optional extension segment possible, can be connected to each other as required
- Air pump included

**Booms:** Air hose

**Material:** 150D polyester

**Dims.:** W 480 x H 140 cm, **Weight:** ca. 6.5 kg

**Scope of delivery:** Windbreak with guy ropes, pegs, air pump and packing bag.

Color: Granite/Black

①      900537      279,-

**Extension segment W 160 x H 140 cm**

Includes guy ropes, pegs and pack bag (without pump). **Weight:** ca. 2 kg

②      900538      109,-







**DARWIN - Dome tent**

- Quick assembly and low weight
- Space for luggage in the dome
- Sleeping area and anteroom
- Aroll-up door

Scope of delivery: flysheet, inner tent, groundsheet, pegs, guy ropes, fiberglass poles, packing bag

① Darwin 2 (2 persons)	96158	105,-
② Darwin 3 (3 persons)	96159	128,-

**DARWIN 3 and 4 Plus Blackout**

- With BlackOut Bedroom technology for a restful sleep
- Stable dome construction
- Large anteroom

③ Darwin 3 Plus Blackout (3 persons)	96160	236,-
④ Darwin 4 Plus Blackout (4 persons)	96161	272,-

**DARWIN**

①+②



ca. 3,4 kg

ca. Ø 16 x 50 cm

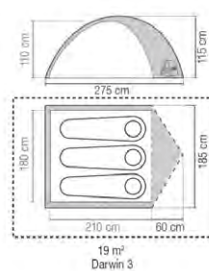

ca. 2,8 kg

ca. Ø 15,5 x 46 cm

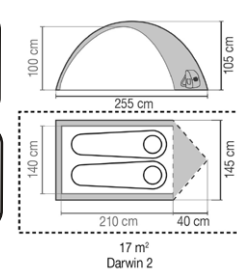

**DARWIN Plus Blackout**

③+④

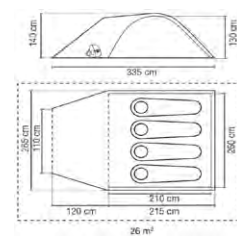
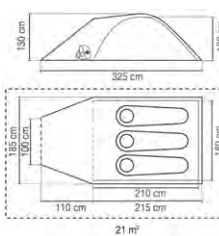



**BREGENZ 2 Z5 / DAKOTA Z5 DELUXE**

Exclusive 4 person camping tents

- High-quality premium workmanship
- Professional boom system with color coding
- Thermo double roof with roof ventilator
- Tent floor retractable with zipper
- 2 comfortable sleeping cabins with optimum roof ventilation

Comfort model for demanding tent fans. It is equipped with 2 sleeping cabins for 2 people each and an airy living area. Generous windows with sun protection & the sophisticated air conditioning system combined with refined details offer the highest possible level of comfort.

Scope of delivery: Tent incl. groundsheet, 2 sleeping cabins, fluorescent guy ropes, pegs, packing bag

**Bregenz 2 Z5**

Dims.: W 280 x H 200 x D 480cm, cm, pack size 69 x 50 x 19 cm, weight ca. 16.4 kg

900070 195,-

**Dakota Z5 Deluxe**

Dims.: W 290 x H 200 x D 510cm, cm, pack size 69 x 50 x 19 cm, weight ca. 18 kg

900071 225,-



from 195,-



2 separate sleeping cabins

- Polyester 210T + UV
- Seams sealed
- 2.000 mm
- Fiberglass/steel
- 100% PES breathable
- 100% polyethylene
- UV protection
- Flame retardant

**ROCKY MOUNTAIN 5 PLUS**

- Quick to pitch tunnel tent with sleeping tent
- Sewn-in PE tent floor
- Night-black sleeping cabin keeps out disturbing light

This spacious & comfortable tunnel tent offers enough space for the whole family when camping. The lightweight yet stable tunnel construction with fiberglass poles enables quick and easy assembly. A large lounge with space for table and chairs and the PVC windows with cover provide light and privacy. The sleeping cabin is equipped with Night Black sleeping cabin technology, which retains 99% of the light and ensures a restful night's sleep.

Scope of delivery: Tent with poles & groundsheet, 1 sleeping cabin, pegs, guy ropes, carrying bag.

90583 629,-



BlackOutBedroom® - extra dark sleeping cabins for a restful night's sleep



- Polyester + PU layer
- Seams sealed
- 4.500 mm
- Fiberglass
- Flame retardant
- Polyethylene
- ca. 16,8 kg
- ca. 70 x 32 x 30 cm





### SPRINGWOOD 4SG

- 4 person tunnel tent
- 1 sleeping cabin + 1 living room
- Durable, waterproof, sewn-in polyethylene tent floor
- Tinted windows for complete privacy
- Cable feed-throughs provide practical access to the power supply for electrical devices.
- Cover tent with fully sealed seams for maximum protection from the weather
- Large windows with roll-up curtains

Outwell Springwood 4SG is ideal for couples & friends who want to experience exciting adventures in the great outdoors together. Thanks to the fiberglass poles, the tent is quick and easy to pitch. It offers relaxed tent living with plenty of floor space, generous headroom and flexible ventilation. With the sewn-on groundsheet, you benefit from a dry, draught-free tent in bad weather and a mosquito-free place on warmer days.

**Scope of delivery:** Tent, inner tent, sewn-in groundsheet, pegs, guy ropes, packing bag

90594

569,-

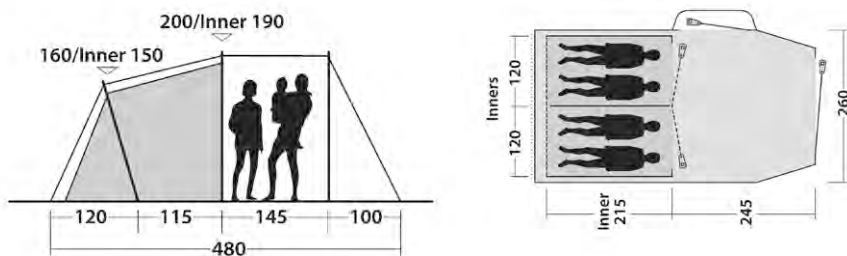

 Outtex® 3000 Select, 100% polyester	 3.000 mm	 Fiberglass	 Flame retardant	 UV protection coated	 ca. 15,3 kg	 ca. 68 x 29 x 29 cm
---	--------------	----------------	---------------------	--------------------------	-----------------	-------------------------



### OCTAGON BLACKOUT for 8 people

- Innovative D-door: can be opened like a conventional door
- Patented BlackOut Bedroom® technology: keeps 99% of daylight out of your sleeping area

Octagon BlackOut offers a full 360° view of your surroundings and provides ample living space for a variety of possibilities: as a luxury glamping bedroom, as a playroom for kids or as a comfortable tent for festivals & the like.

The outer tent can be removed and the tent transforms into an insect-free outdoor room.

The tent is supplied with a bag with wheels to facilitate transportation and storage.

90593

549,-

**BlackOutBedroom®** - extra dark sleeping cabins for a restful night's sleep

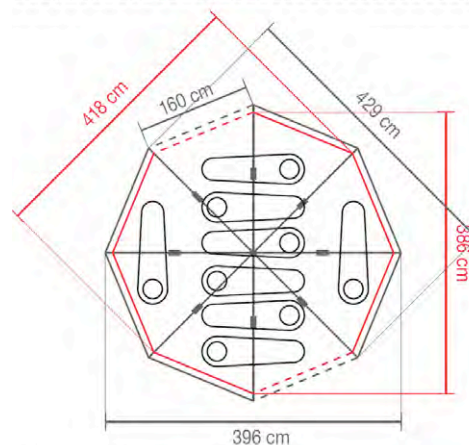

 Flame retardant	 Polyester + PU layer	 Seams sealed	 100% polyethylene	 Fiberglass & Steel	 4.500 mm	 ca. Ø 30 x 85 cm	 ca. 20,7 kg
---------------------	--------------------------	------------------	-----------------------	------------------------	--------------	----------------------	-----------------





**LED Camping light lighthouse**

- Rechargeable lithium battery
- Pleasantly warm light
- Dimmable,

can be used as a power bank  
Camping light with rechargeable battery for maritime flair at home & on the go. Several light modes can be set: flickering flame mode or characteristic lighthouse flashing mode.

Made from high-quality materials (bamboo + stainless steel). Lithium battery 5000 mAh/6W/210 lumen. Dimensions: Ø 13 cm height 25/32 cm.

Weight: 0.6 kg **834874 49,95**



**Noble LED retro light**

- High-quality materials bamboo, metal and plastic
- With ring and handle for carrying and hanging
- Dimmable & can be used as a power bank

USB charging cable included. Lithium battery 3.7 V, 5000 mAh. Power: 3.2 W, 220 lumens. Charging time: 7 hours  
Dimensions: Ø 13 cm Height 25/32 cm, weight: 0.75 kg  
**834873 54,95**

**29,90**



**① table lamp COSY**

- Touch sensor on the lampshade
- 3 brightness levels adjustable
- Warm white cozy light for your tent
- Suitable for outdoor use (protection class IP44)

Rechargeable 2000 mAh Li-ion battery. 3.7 V, 3000K. Incl. USB charging cable. Total height 30 cm, base H 15 x Ø 16.5 cm. Foot can be unscrewed. Weight: ca. 0.7 kg. Color white, anthracite base **831951 29,90**



**② Stella LED tent light**

- Ideal for motorhome and caravan awnings
- 5 levels: 100% / 50% light output / RGB color change / RGB continuous light / OFF
- Incl. Hook, suspension cable & ground spike
- Can also be used as a table or floor lamp

Rechargeable 2200 mAh Li-ion battery. 2.5W, 16 LEDs. Incl. USB charging cable. Dims.: Ø 20cm, weight: ca. 0.6 kg. Color: shade white, base anthracite. **83195 39,90**



**LIGHT TO GO luminaire**

- 100% recyclable
- Made in Germany, 100% CO2 neutral product
- Long battery life

Mobile light for indoors and outdoors with up to 14 hours of battery life. Dimmable in 4 levels with integrated power bank, incl. USB cable & 5 m connection cable

**Material:** thermoplastic material  
**Dimensions:** Ø 18 cm height 28 cm  
**Color:** White/Grey

**917615 65,95**



**LED torch lights for cozy camping evenings**

- Atmospheric, realistic flame effect
- Rechargeable via micro USB

**① LED tablelamp with Bluetooth speaker**

LED table lamp with integrated Bluetooth speaker. Uncomplicated pairing with the smartphone. Transmission range >10 m. Volume >90dB. Power supply: 5V 1A. Output power: 5W. 2000 mAh Li-Polymer battery. Material: ABS. Dims.: Ø 98 x H165 mm  
**83184 27,95**

**② LED torch with flame effect**

Authentic flame effect with 96 LEDs. 2W, 100-200 lumens. Integrated 2200 mAh battery. Rechargeable via solar panel in the lid or via micro USB cable. Dims.: Ø 95 mm, with 4 rod elements, max. height 830 mm  
**83588 24,95**







from **14,95**

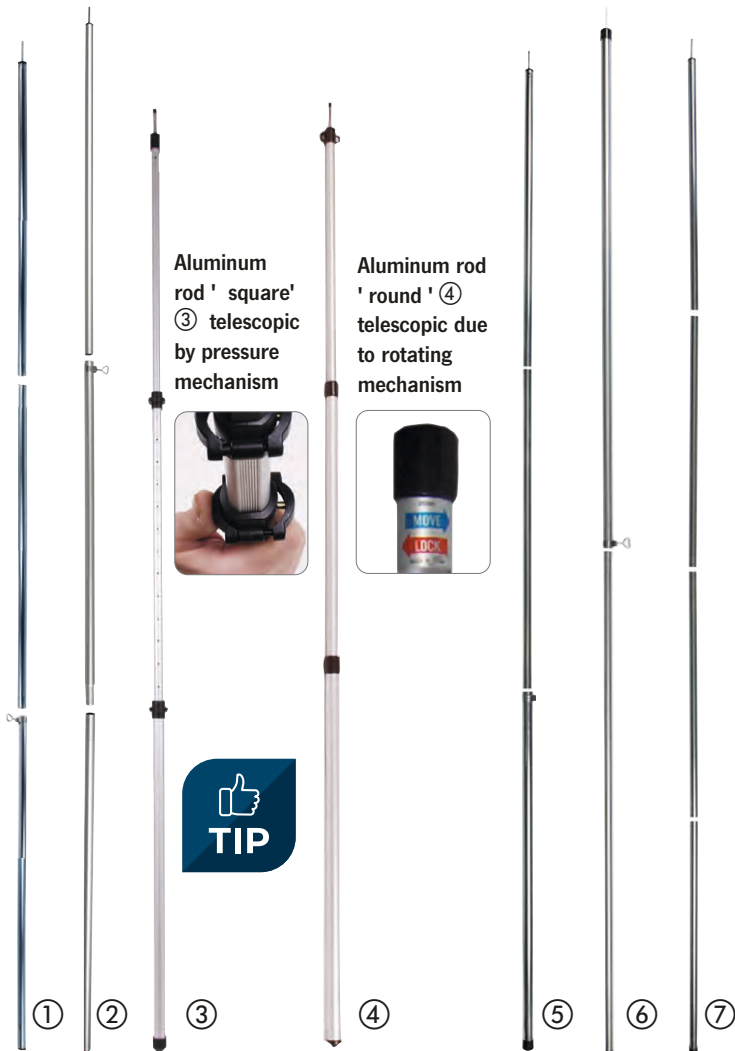

**Set-up bars**

- ① **Steel support pole, Ø 22 mm, 3-part**  
with screw, telescopic, length 165-250 cm  
**90307 34,30**
- ② **Aluminum support rod, Ø 25 mm, 3-part**  
with screw, telescopic, Length 170-260 cm  
**903070 28,95**
- ③ **Luxury aluminum telescopic pole square with push button for locking**  
Ø 30 mm, 3-part, ca. 95 - 230 cm, pack size 96 cm  
**903682 27,95**
- ④ **Luxury Round aluminum telescopic pole with push button for locking**  
Ø 30 mm, 3-part, ca. 95 - 230 cm, pack size 96 cm  
**90370 19,95**
- ⑤ **Support rod Ø22 mm, 3 parts, 2 pcs.**  
180-220 cm, steel, telescopic  
**903077 24,95**
- ⑥ **Support rod Ø22 mm, 2 parts**  
110-200 cm, steel, telescopic  
**903071 21,90**
- ⑦ **Set-up rod, 4 pieces, 2 pcs.**  
196 cm, steel, not telescopic  
**903076 14,95**

All bars only available in self-service packaging.







**Additional tent poles**

- ① **Connecting rod Ø 22 mm** 2-part, telescopic, steel, tube clamp, tube clamp, tent pole base length 250 cm  
**90362 12,95**
- ② **Roof support bar Ø 22 mm**  
 With tube clamp on both sides, aluminum.  
 Length 25-040 cm, 2-parts **90334 17,95**  
 Length 170-250 cm, 3-parts **90337 23,90**
- ③ **Spacers Ø 22 mm** 1-piece, gable/ridge extension of awning frames, aluminum, length 90 cm/usable length 80 cm  
**90332 9,30**
- ④ **Roof hook pole (ridge pole) Ø 25 mm**  
 3-part, with hook & pipe clip, aluminum Length 170-260 cm  
**90358 29,95**
- ⑤ **Clamping rod/lock rod for mini camper, steel, Ø16 mm,**  
 255 cm long. **99444 8,40**



**Easy System**



You can put together additional rods to suit your own requirements, as rod & rod end section can be freely combined with each other. Bar end sections can be changed at any time.



**When putting together "your" combination, please pay attention to the color dots. Always use larger diameters at the top.**

	<b>2-piece rod</b> Length: 120 - 200 cm		
	Ø 22 + 19 mm alu.	<b>905032</b>	<b>21,20</b>
	Ø 25 + 22 mm alu.	<b>905031</b>	<b>21,20</b>
	Ø 28 + 25 mm alu.	<b>90503</b>	<b>23,40</b>
	<b>3-piece rod</b> Length: 120 - 280 cm		
	Ø 25 + 22 + 19 mm alu.	<b>905055</b>	<b>32,80</b>
	Ø 28 + 25 + 22 mm alu.	<b>90505</b>	<b>32,80</b>
	<b>Intermediate piece</b> Length: 92 cm		
	Ø 25 mm alu.	<b>905311</b>	<b>34,60</b>
	Ø 28 mm alu.	<b>90531</b>	<b>25,80</b>
	<b>Bottom tip</b>		
	Ø 19 mm	<b>905061</b>	<b>4,10</b>
	Ø 22 mm	<b>90506</b>	<b>3,90</b>
	Ø 25 mm	<b>90507</b>	<b>4,30</b>
	<b>Floor glider</b>		
	Ø 19 mm	<b>905091</b>	<b>3,60</b>
	Ø 22 mm	<b>90509</b>	<b>3,20</b>
	Ø 25 mm	<b>90510</b>	<b>3,80</b>
	Ø 28 mm	<b>90511</b>	<b>3,90</b>

	<b>Pen</b>		
	Ø 19 mm	<b>905121</b>	<b>3,60</b>
	Ø 22 mm	<b>90512</b>	<b>3,90</b>
	Ø 25 mm	<b>90513</b>	<b>3,70</b>
	Ø 28 mm	<b>90514</b>	<b>3,90</b>
	<b>Hook</b>		
	Ø 19 mm	<b>905191</b>	<b>3,60</b>
	Ø 22 mm	<b>90519</b>	<b>3,80</b>
	Ø 25 mm	<b>90520</b>	<b>3,80</b>
	Ø 28 mm	<b>90521</b>	<b>4,30</b>
	<b>Eyelets</b>		
	Ø 19 mm	<b>905221</b>	<b>3,99</b>
	Ø 22 mm	<b>90522</b>	<b>4,20</b>
	Ø 25 mm	<b>90523</b>	<b>4,60</b>
	Ø 28 mm	<b>90524</b>	<b>4,70</b>
	<b>Housing</b> as Spare part		
	Ø 22-19 mm	<b>905281</b>	<b>7,20</b>
	Ø 25-22 mm	<b>90528</b>	<b>7,40</b>
	Ø 28-25 mm	<b>90529</b>	<b>7,40</b>



# QUALITY TENT POLESMADE OF STEEL OR ALUMINUM



**BEST PRICE**

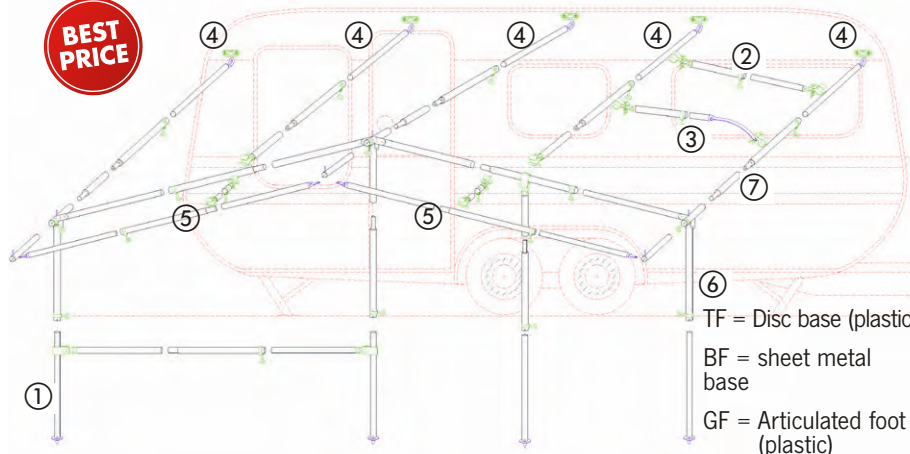

**PIPER tent poles** made of aluminum or steel in premium quality. The rods meet the highest demands in terms of function, accuracy of fit & stability. All PIPER premium poles are "Made In Germany".

Of course, we also offer **tent poles** made of aluminum or steel at top prices. These poles are also suitable for awnings, house tents, sun canopies or tarps. All BestPrice rods have a **GREY** background.

①



RK = Pipe cap (plastic)

TF = Disc base (plastic)

GF = Articulated foot (plastic)



## Telescopic support rod

	Length	Bar Ø	Pipe thickness	Material	Number of parts	Item no.	Price
TF	165 - 250 cm	22/25 mm	1,0 mm	Steel	3-piece	<b>918541</b>	<b>24,60</b>
RK	125 - 205 cm	19/22 mm	1,0 mm	Steel	2-piece	<b>918542</b>	<b>19,95</b>
TF	125 - 205 cm	19/22 mm	1,0 mm	Steel	2-piece	<b>918543</b>	<b>19,40</b>
RK	165 - 250 cm	19/22 mm	1,0 mm	Steel	3-piece	<b>918544</b>	<b>22,20</b>
TF	165 - 250 cm	19/22 mm	1,0 mm	Steel	3-piece	<b>918545</b>	<b>22,80</b>
GF	165 - 260 cm	28/32 mm	1,5 mm	Alu	3-piece	<b>918546</b>	<b>41,20</b>
RK	165 - 260 cm	22/25 mm	1,5 mm	Alu	3-piece	<b>918547</b>	<b>28,50</b>
	80 - 220 cm	22 mm	1,0 mm	Alu	3-piece	<b>905080</b>	<b>20,30</b>
	170 - 250 cm	25 mm		Steel		<b>903091</b>	<b>31,80</b>
	180 - 250 cm	22/19 mm		Steel	3-piece	<b>905081</b>	<b>25,70</b>

②

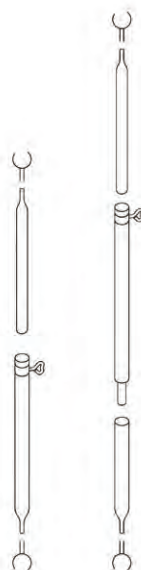

## Clamping rods - pipe clamps on both sides

	Length	Bar Ø	Pipe thickness	Material	Number of parts	Item no.	Price
	185 - 260 cm	32/28 mm	1,5 mm	Steel	3-piece	<b>91810</b>	<b>33,95</b>
	160 - 260 cm	25/22 mm	1,0 mm	Steel	3-piece	<b>91811</b>	<b>23,40</b>
	50 - 80 cm	22/19 mm	1,0 mm	Steel	2-piece	<b>918141</b>	<b>13,10</b>
	80 - 120 cm	22/19 mm	1,0 mm	Steel	2-piece	<b>91813</b>	<b>14,50</b>
	120 - 205 cm	22/19 mm	1,0 mm	Steel	2-piece	<b>91814</b>	<b>15,50</b>
	160 - 260 cm	22/19 mm	1,0 mm	Steel	3-piece	<b>91815</b>	<b>20,50</b>
	215 - 300 cm	22/19 mm	1,0 mm	Steel	3-piece	<b>91816</b>	<b>22,40</b>
	80 - 120 cm	28/25 mm	1,0/1,2 mm	Alu	2-piece	<b>918171</b>	<b>22,20</b>
	120 - 205 cm	28/25 mm	1,0/1,2 mm	Alu	2-piece	<b>918172</b>	<b>25,20</b>
	160 - 260 cm	28/25 mm	1,0/1,2 mm	Alu	3-piece	<b>91817</b>	<b>27,50</b>
	120 - 200 cm	25/22 mm	1,2 mm	Alu	2-piece	<b>91818</b>	<b>21,40</b>
	160 - 260 cm	25/22 mm	1,2 mm	Alu	3-piece	<b>91819</b>	<b>25,30</b>
End piece	25 - 40 cm	22 mm		Steel	2-piece	<b>90334</b>	<b>17,95</b>
	70 - 120 cm	22 mm		Steel	2-piece	<b>90335</b>	<b>17,20</b>
	120 - 200 cm	22 mm		Steel	3-piece	<b>903350</b>	<b>21,50</b>
	170 - 250 cm	22 mm		Steel	3-piece	<b>90336</b>	<b>29,90</b>
	170 - 250 cm	25 mm		Steel	3-piece	<b>903361</b>	<b>29,80</b>
	170 - 250 cm	25/22 mm		Alu	3-piece	<b>90337</b>	<b>23,90</b>
	170 - 260 cm	28 mm		Alu	3-piece	<b>903371</b>	<b>30,99</b>

③

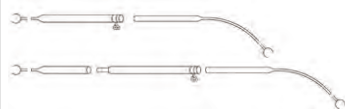





## Clamping rods with spring steel end - pipe clamps on both sides

	Length	Bar Ø	Pipe thickness	Material	Number of parts	Item no.	Price
	210 - 255 cm	25/22 mm	1,0 mm	Steel	3-piece	<b>91840</b>	<b>24,70</b>
	80 - 115 cm	22/19 mm	1,0 mm	Steel	2-piece	<b>91841</b>	<b>16,20</b>
	110 - 160 cm	22/19 mm	1,0 mm	Steel	2-piece	<b>91842</b>	<b>18,50</b>
	210 - 255 cm	22/19 mm	1,0 mm	Steel	3-piece	<b>91843</b>	<b>25,60</b>
	210 - 275 cm	25 mm		Alu	3-piece	<b>90608</b>	<b>26,80</b>

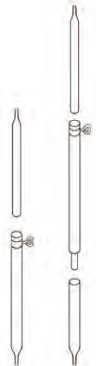





⑤

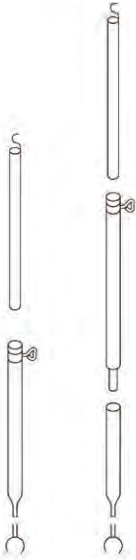

Canopy tenting poles - with hole for tent pole tip on both sides							
	Length	Bar Ø	Pipe thick-ness	Material	Number of parts	Item no.	Price
 	90 – 150 cm	22/19 mm	1,0 mm	Steel	2-piece	<b>91853</b>	<b>15,30</b>
	120 – 210 cm	22/19 mm	1,0 mm	Steel	2-piece	<b>91854</b>	<b>13,40</b>
	200 – 280 cm	22/19 mm	1,0 mm	Steel	3-piece	<b>91859</b>	<b>18,10</b>
	130 – 205 cm	25/22 mm	1,2 mm	Alu	2-piece	<b>91852</b>	<b>18,60</b>
	180 – 250 cm	22/19 mm		Steel		<b>903102</b>	<b>32,90</b>
	250 – 300 cm	19 mm		Steel		<b>903103</b>	<b>40,90</b>

④



Ridge poles - with hook and pipe clamp								
	Length	Bar Ø	Pipe thick-ness	Material	Number of parts	Item no.	Price	
 	185 – 260 cm	32/28 mm	1,5 mm	Steel	3-piece	<b>91801</b>	<b>35,10</b>	
	215 – 300 cm	32/28 mm	1,5 mm	Steel	3-piece	<b>918011</b>	<b>40,20</b>	
	160 – 260 cm	28/25 mm	1,0 mm	Steel	3-piece	<b>91802</b>	<b>24,70</b>	
	220 – 300 cm	28/25 mm	1,0 mm	Steel	3-piece	<b>91803</b>	<b>24,80</b>	
	160 – 260 cm	25/22 mm	1,0 mm	Steel	3-piece	<b>91804</b>	<b>21,80</b>	
	215 – 300 cm	25/22 mm	1,0 mm	Steel	3-piece	<b>91805</b>	<b>20,80</b>	
	120 – 205 cm	22/19 mm	1,0 mm	Steel	2-piece	<b>91806</b>	<b>17,80</b>	
	160 – 260 cm	22/19 mm	1,0 mm	Steel	3-piece	<b>91807</b>	<b>21,60</b>	
	160 – 260 cm	32/28 mm	1,5 mm	Alu	3-piece	<b>918081</b>	<b>40,70</b>	
	225 – 300 cm	32/28 mm	1,5 mm	Alu	3-piece	<b>918082</b>	<b>43,10</b>	
	160 – 260 cm	28/25 mm	1,0/1,2 mm	Alu	3-piece	<b>91808</b>	<b>28,40</b>	
	160 – 260 cm	25/22 mm	1,0/1,2 mm	Alu	3-piece	<b>91809</b>	<b>27,10</b>	
		170 – 250 cm	22 mm		Steel		<b>90312</b>	<b>25,20</b>
		170 – 250 cm	25 mm		Steel		<b>903121</b>	<b>28,30</b>
170 – 260 cm		28/25 mm		Alu	3-piece	<b>903126</b>	<b>32,20</b>	
170 – 260 cm		25 mm		Alu		<b>90358</b>	<b>29,95</b>	
170 – 260 cm		25/22 mm		Alu		<b>903124</b>	<b>30,40</b>	

⑥

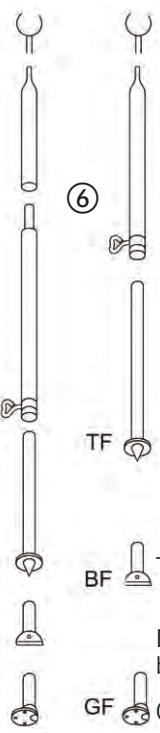

TF = Disc base (plastic)

BF = sheet metal base

GF = Articulated foot (plastic)

Storm poles - with hinged, plate or sheet metal base & pipe clamp							
Bar end	Length	Bar Ø	Pipe thick-ness	Material	Number of parts	Item no.	Price
GF	180 – 260 cm	32/28 mm	1,5 mm	Steel	3-piece	<b>91844</b>	<b>30,40</b>
BF	180 – 260 cm	32/28 mm	1,5 mm	Steel	3-piece	<b>918441</b>	<b>34,99</b>
GF	165 – 260 cm	28/25 mm	1,0 mm	Steel	3-piece	<b>91845</b>	<b>25,50</b>
BF	165 – 260 cm	28/25 mm	1,0 mm	Steel	3-piece	<b>918551</b>	<b>24,40</b>
TF	165 – 260 cm	25/22 mm	1,0 mm	Steel	3-piece	<b>91847</b>	<b>20,70</b>
TF	165 – 260 cm	22/19 mm	1,0 mm	Steel	3-piece	<b>91849</b>	<b>22,20</b>
GF	125 – 205 cm	25/22 mm	1,0 mm	Steel	2-piece	<b>91846</b>	<b>19,30</b>
GF	125 – 205 cm	22/19 mm	1,0 mm	Steel	2-piece	<b>91848</b>	<b>17,70</b>
GF	180 – 260 cm	32/28 mm	1,0/1,2 mm	Alu	3-piece	<b>918502</b>	<b>34,30</b>
BF	180 – 260 cm	32/28 mm	1,0/1,2 mm	Alu	3-piece	<b>918503</b>	<b>35,70</b>
GF	165 – 260 cm	28/25 mm	1,0/1,2 mm	Alu	3-piece	<b>91850</b>	<b>27,90</b>
BF	165 – 260 cm	28/25 mm	1,0/1,2 mm	Alu	3-piece	<b>918501</b>	<b>27,90</b>
TF	165 – 260 cm	25/22 mm	1,2 mm	Alu	3-piece	<b>91851</b>	<b>25,30</b>
	GF	170 – 250 cm	25/22 mm	Steel	2-piece	<b>903091A</b>	<b>36,20</b>
	GF	170 – 250 cm	28/25 mm	Steel	3-piece	<b>903230A</b>	<b>38,70</b>
	TF	170 – 250 cm	22 mm	Steel		<b>90309</b>	<b>29,80</b>
	TF	170 – 250 cm	25 mm	Steel		<b>903091</b>	<b>31,80</b>
	TF	170 – 250 cm	25 mm	Alu		<b>90323</b>	<b>24,60</b>



# ACCESSORIES TENT POLES



## Roof support rods bent - pipe clamps on both sides



Length	Bar Ø	Pipe thickness	Material	Number of parts	Item no.	Price
170 – 250 cm	22 mm		Steel	3-piece	90359	28,60

## Intermediate pieces / Extension tubes - cranked on one side

⑦

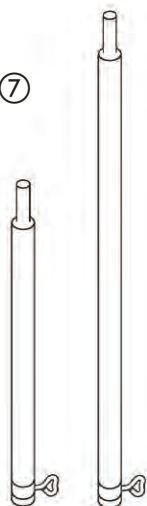

Effective length	Bar Ø	Pipe thickness	Material	Quantity	Item no.	Price
50 cm	32 mm	1,5 mm	Steel	2 piece	91950	16,30
100 cm	32 mm	1,5 mm	Steel	2 piece	91951	21,40
50 cm	28 mm	1,0 mm	Steel	2 piece	91952	14,40
100 cm	28 mm	1,0 mm	Steel	2 piece	91953	17,95
50 cm	25 mm	1,0 mm	Steel	2 piece	91954	11,95
100 cm	25 mm	1,0 mm	Steel	2 piece	91955	15,60
50 cm	22 mm	1,0 mm	Steel	2 piece	91957	11,90
100 cm	22 mm	1,0 mm	Steel	2 piece	91961	14,95
50 cm	19 mm	1,0 mm	Steel	2 piece	919611	11,95
100 cm	19 mm	1,0 mm	Steel	2 piece	919612	15,50
50 cm	32 mm	1,5 mm	Alu	2 piece	91962	20,50
100 cm	32 mm	1,5 mm	Alu	2 piece	919621	29,70
50 cm	28 mm	1,0 mm	Alu	2 piece	91963	14,99
100 cm	28 mm	1,0 mm	Alu	2 piece	919631	20,40
50 cm	25 mm	1,2 mm	Alu	2 piece	91964	14,70
100 cm	25 mm	1,2 mm	Alu	2 piece	91965	21,50
50 cm	22 mm	1,2 mm	Alu	2 piece	919632	6,90
100 cm	22 mm	1,2 mm	Alu	2 piece	919633	9,99
70/65 cm	22 mm		Steel	1 piece	903540	10,20
110 cm	22 mm		Alu	1 piece	903542	12,60
80 cm	22 mm		Alu	1 piece	90332	9,30



## Clamping mechanism PowerGrip

- No deformation of the pipe
- Clamping mechanism w/o. galvanized steel parts
- Visually effective
- Can be retrofitted



**PowerGRIP**

PowerGrip is a clamping device that makes the screw connection superfluous. PowerGrip makes pitching the tent easier. When unclamping the boom, it is sufficient to press the clamping mechanism lightly so that the tube is locked. This proven system can be subsequently exchanged for the pipe clamp.

Ø 32 mm / Ø 28 mm	91973	25,60
Ø 28 mm / Ø 25 mm	91972	23,40
Ø 25 mm / Ø 22 mm	91971	19,90
Ø 22 mm / Ø 19 mm	91970	18,90



## Windbreak accessories

**Tent pole plate** made of rubber for tube diameter or floor gliders 18 to 28 mm, H 20 x Ø 50 mm, 5 pieces  
90298 4,90



**Universal tent pole coaster** for ground gliders up to 30 mm & hurricane supports with tip/ball base. 30 x Ø 90 mm, unbreakable plastic. 3 fixing holes for pegs or screws. 4 piece  
90297 7,40



**Base plate** for hurricane supports with tip. H30 x Ø 115 mm, unbreakable plastic. 3 fixing holes for pegs or screws. 4 piece  
90296 8,95



① Windbreak bar	150 cm long, Ø 25 mm	90356	12,40
② Intermediate tube	95 cm long, steel Ø 25 mm	903561	7,20
③ Intermediate tube	146 cm long, Ø 25 mm	903562	10,40
④ End angle	Ø 28 mm	903563	12,30
⑤ T-piece	Ø 28 mm, 200/103 mm	903564	12,60
⑥ Corner piece	Ø 28 mm,	903565	17,90



Canopy support

1 PU = 3 pieces

Bar Ø	Material	Length	Item no.	Price
Ø 22 mm	Steel	26,5 cm	90248	23,80
Ø 25 mm	Steel	26,5 cm	902481	26,30
Ø 22 mm	Alu	26,5 cm	90247	27,40
Ø 25 mm	Alu	26,5 cm	902471	26,90

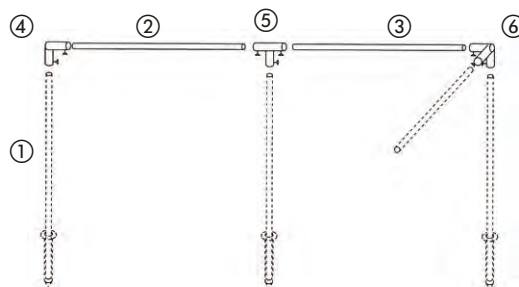





Accessories for tent poles



**Heart screw M6**  
Galvanized iron, 10 pieces  
90322 5,50



**Pipe clamp with screw**,  
Inox, for boom tube, 5 pcs.  
Ø 18 mm 903201 5,10  
Ø 21-23 90320 5,90  
Ø 24-26 90321 5,90  
Ø 26-28 903211 6,90



**Metal pipe clamp**, for boom tube with wing nut and screw. 2 piece Ø 22-25 mm  
90300 4,40  
Ø 25-28 mm 903001 4,20  
Ø 28-32 mm 903002 5,60



**Rohrschelle rubberized**, for Ø 25 - 28 mm. Wing nut with screw, 2 pieces  
903521 5,90



**Tent wardrobe** with 2 hooks for hanging on tent poles & 5 movable Hooks. Length 45 cm  
90327 3,90



**Double pipe clamp** with 2 wing nuts & screws  
For Ø 22 / 25 mm  
2 pcs. 903524 4,90  
For Ø 28 / 32 mm  
2 piece 903525 5,20



**Corner pipe clamp** with 2 wing nuts & screws  
For Ø 22 + /25 mm  
2 pcs. 903522 9,10  
For Ø 28 + 32 mm  
2 piece 903523 8,90



**Lock screw** Steel, M6 x 20, 10 pieces  
90383 2,10



**Wing nut M6, steel**  
10 pcs. 90384 5,60

**Wall eyelets for caravan ridge poles: see next page**



**Retaining springs**  
Ø 5 x 7 mm  
5 pcs. 90311 3,60



**Tent pole tip**  
2 pieces  
Ø 22 mm 90375 2,90  
Ø 25 mm 90376 3,-



**Tent pole base** 10 pieces  
Ø 22 mm 90377 7,90  
Ø 25 mm 90378 6,90



**Tent peg curved**  
2 piece  
Ø 22 mm 90381 3,10  
Ø 25 mm 90382 5,50



**Bottom tip** 5 pieces  
Ø 25 mm 90380 2,40

**Hook rail with 8 hooks, piping + Velcro fastener**  
Hook rail for awning, caravan or awning. Velcro at the back for tent pole or 7 mm piping. Material 600D Oxford, 8 plastic hooks, length 58 x height 20 cm.  
903271 6,95

**Suspension hook**  
Galvanized, special shape prevents damage to the tent wall. 7,5 cm  
5 piece 90340 2,50



**Rain deflector cap** for tent pole pin, transparent plastic, Ø 8 mm, 8 pieces  
90346 3,99



**Aluminum tip**  
Nylon T-clamp  
22 - 19 mm 3 pieces 90326 6,30  
22 - 22 mm. 3 pieces 90328 7,80



**Inner tent hook** made of plastic, 25 mm total length, 10 piece 90341 3,95



**Inner tent hooks** with slot 20 - 25 mm  
5 pieces 90316 5,60



**Inner tent hooks** Nylon 19 - 22 mm  
5 piece 90317 5,99



**Clamp coat hook** 2-fold, hold due to strong clamping spring.  
90342 3,95



# AWNING TENT ACCESSORIES

## Awning fastening without drilling



### Quick Lock Padset

Caravan awning fastening without drilling, screwless bracket  
 2 pieces underside smooth **935076**  
 2 pieces underside heel **935077**

**10,95**  
**10,95**



### Quick Lock Pads Set

For all tents with double piping. Without drilling for Caravan awning fastening. Clamping eyes hold by tensioning the linkage  
**set of 3** **935074**

**33,70**



### Awning clips

- Attachment to the caravan without drilling
- Screwless fastening
- Variable use

3 pieces gray/black **935080**

**9,95**



**6**  
PIECE SET

### Keder eyelets 5+7 mm

- Multifunctional

The keder eyelets have a 5 mm keder on one side and a 7 mm keder on the other. Suitable for caravans, motorhomes, awnings and multitrails. Can be used, for example, as a holder for storm lines, solar showers, utensil bags, coat hooks, etc. The 6-piece set should not be missing from any basic camping equipment

**901693**

**4,95**

## Awning fastening without drilling with hinged suction cups

For screwless attachment of canopies, awnings, etc. Place suction cup on a smooth, clean & dry surface & move the lever.



### Plastic folding suction cup

With sturdy hook.

Ø 100 mm. Loadable up to ca. 10 kg  
**1 pc. 93648 11,95**  
 Ø 120 mm. Loadable up to ca. 15 kg  
**1 pc. 936480 50,60**

### Folding suction cup cast aluminum,

Ø 120 mm Plate made of natural rubber Suction disk Ø 120 mm, loadable up to ca. 10 kg with screw thread for various suction cups. Fastenings. Made in Germany

**1 pc. 93647 50,60**

### Folding suction cup for attaching the

Ø 55 mm sluice pole Loadable up to ca. 8 kg. Without tube holder,  
**1 pc. 93646 43,60**

### Folding suction cup with ring + 2 S-hooks, Ø 115 mm

The suction cup is simply placed on a smooth, clean & dry vehicle surface & then the lever is flipped. Loadable up to 10 kg

**1 pc. 936471 9,95**



### SHS fitting

Screwless bracket system for attaching the poles to the caravan or camper without drilling.

**set of 3 90907 26,50**

## Screw-on awning fastening

Wall eyelets for attaching awnings and canopies. For screwing on - 5 pieces.



**Vertical mounting, Plastic 90313 2,70**



**Horizontal mounting, Plastic 902181 3,40**



**Vertical mounting, Aluminum 90219 6,90**



**Horizontal mounting, Aluminum 90218 6,90**







**from 10,90**

**Roof retaining strap and storm protection**

- Storm protection for awning or awning
- Particularly sturdy design, TÜV/GS tested
- Belt length 11 + 14 m - extra long
- Prevents the awning or blind from blowing up
- Complete with pegs & tension spring
- 4 cm wide black straps

Length: 11 m	432882	10,90
Length: 14 m	432881	14,90



**2**  
PIECES



**JUMBO CLAMP**

**Anti-flutterClamps for awnings, sun sails, tarpaulins, etc.**

- Easy to fix
- Also available as an extra wide jumbo version
- Prevents fluttering noises • Reduces damage

① 2 pieces with 1x short and long belt each	901276	12,95
② Clamp Jumbo 1 piece extra wide	901275	19,95



*Isabella*

www.isabella.net

**Storm protection kit for Isabella and other awnings**

- Secures the awning additionally in strong winds
- Prevents tent canvas wear
- Robust storm straps
- Mounted inside the tent

Set	93572	27,-
-----	-------	------



**Awning storm strap set**

- secure fastening of the awning

**Scope of delivery:**  
 2x steel pegs 38cm  
 2x spring 10cm  
 2x nylon strap with plastic hooks 4.8 m  
 2x triangular strap width piping 17.5cm

**Weight: ca. 1 kg**

432883	17,95
--------	-------

**Protective pads for vehicle exterior wall/awning protection**

- For optimum attachment of the awning air hose to the vehicle
- Protects your vehicle

Protective pads 12x12x2 cm, 8pcs

8pcs	904402	11,30
------	--------	-------





**Protection set for storm safety devices**

Tent roof/webbing protector for roof retaining tape 6 cm wide.

**3 pieces in a set**

43541	7,90
-------	------

**You can find more storm protection in the awnings section**



# CARAVAN PROFILES & TENT CONNECTION STRIPS



**Keder profile rail** 

Keder profile rail mounted in groove with small Sheet metal friction screws (e.g. stainless steel), size 3.9 x 16 mm to vehicle. Silver anodized aluminium, for 6-8 mm piping. Price per bar.

2,5 m	<b>90115</b>	<b>30,10</b>
	GP* 12,04/1 m	
5,0 m	<b>90116</b>	<b>52,20</b>
	GP* 10,44/1 m	

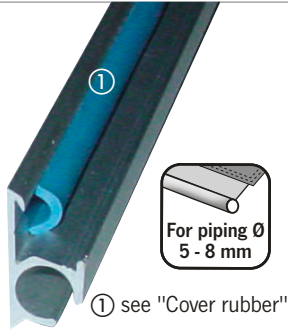

**Keder rail with screw channel** 

Easier to screw on than the Keder profile rail (90115). Anodized aluminium for piping 5-8 mm

2,5 m	<b>901171</b>	<b>42,70</b>
	GP* 17,08/1 m	
5,0 m	<b>90117</b>	<b>66,50</b>
	GP* 13,30/1 m	

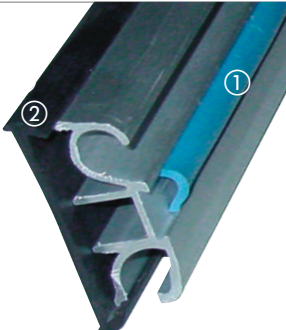

**Feed rail** 

Height 43 mm, for piping 7.5 mm

3 m	<b>901943</b>	<b>41,95</b>
	GP* 13,98/1 m	
② suitable Gasket		
3 m	<b>901996</b>	<b>14,95</b>
	GP* 4,98/1 m	
matching end caps		
left	<b>901946</b>	<b>1,40</b>
right	<b>901947</b>	<b>1,40</b>

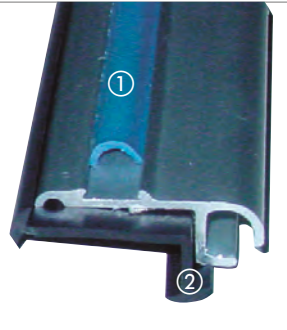

**Awning pull-in bar** 

Leg dim. 27 x 11 mm, for piping 7.5 mm

2 m	<b>901932</b>	<b>26,95</b>
	GP* 13,47/1 m	
3 m	<b>901933</b>	<b>39,95</b>
	GP* 13,32/1 m	
② suitable Gasket		
10 meters	<b>901988</b>	<b>36,95</b>
	GP* 3,70/1 m	



**① Cover rubber**

Filler profile/cover rubber for screw channel on piping rail, fits all models. Width 12 mm

**Roll with 10 m** GP\* 0,70/1 m

Silver	<b>90124</b>	<b>6,99</b>
Black	<b>90122</b>	<b>6,99</b>
Red	<b>901191</b>	<b>6,99</b>
Blue	<b>90131</b>	<b>5,95</b>

**Rolle mit 200 m** GP\* 0,35/1 m

Silver	<b>901240</b>	<b>71,-</b>
Black	<b>90123</b>	<b>70,40</b>
Red	<b>90119</b>	<b>70,20</b>
Blue	<b>901310</b>	<b>79,-</b>



**①** see "Cover rubber"

**Edge trim**

Leg dimension 27 x 11 mm, for piping 7.5 mm

2 m	<b>901962</b>	<b>19,95</b>
	GP* 9,97/1 m	
3 m	<b>901963</b>	<b>28,95</b>
	GP* 9,65/1 m	
② suitable Gasket		
10 meters	<b>901988</b>	<b>36,95</b>
	GP* 3,70/1 m	



**Cover strip**

For sheet metal connections, dims. 30 x 4 mm

2,4 m	<b>90190</b>	<b>25,95</b>
	GP* 10,81/1 m	



**Adapter strip for airlock rod**

For connection to a vehicle without keder rail: With the double keder rail Art.No. 90120 and the adapter 906891 (1 side keder, other side tunnel for sluice bar), the keder connection is converted into a sluice binding.

**Adapter strip 2.50 m**

<b>906891</b>	<b>121,-</b>
---------------	--------------



**PVC piping Ø 5 mm**

With fabric reinforcement in white plastic. 22 mm tab for sewing or gluing to the tent fabric. 5 mm bead (for Mercedes Marco Polo)

Roll 50 m	<b>901214</b>	<b>215,-</b>
	GP* 4,30/1 m	
10 meters	<b>901284</b>	<b>43,90</b>
	GP* 4,39/1 m	



**PVC piping Ø 7.5 mm**

With fabric reinforcement on both sides, white plastic. 20 mm tab for sewing or gluing on the tent fabric. 0.7 mm bead

Roll 100 m	<b>901212</b>	<b>183,-</b>
	GP* 1,83/1 m	
Roll 10 m	<b>901213</b>	<b>19,95</b>
	GP* 1,99/1 m	
Roll 5 m	<b>901216</b>	<b>12,-</b>
	GP* 2,40/1 m	



**PVC double piping Ø 7.5/4 .5 mm**

Plastic with fabric insert (e.g. as an adapter for awnings on Vito F in conjunction with double piping rail). Tab ca. 40 mm. 7.5 to 0.45 mm bead.

Roll 100 m	<b>901281</b>	<b>356,-</b>
	GP* 3,56/1 m	
Roll 10 m	<b>901282</b>	<b>41,90</b>
	GP* 4,19/1 m	
Roll 5 m	<b>901283</b>	<b>26,50</b>
	GP* 5,30/1 m	

**... suitable care product**



**Yachticon- Zipper & piping spray**

For zippers and easier insertion of piping in awnings. Stuck parts become smooth-running again. Eliminates and prevents squeaking in moving parts.

200 ml	<b>61450</b>	<b>13,20</b>
	GP* 66,00 / 1Liter	

Hazard: H222, H229, H315, H326, H411

**i** **Aluminum strips** are often used in caravan and motorhome construction to seal seams on the bodywork securely against water and to conceal them visually. Some slats are also fitted with piping rails for 7.5 mm retractable piping with the option of inserting tents, awnings or windbreaks. **Please note the flat-rate freight charges = flat-rate freight charges from 2.50 m V25 25.90**



**Travel double piping adapter**

In two lengths

- with zipper
- easy attachment and removal of awnings
- makes it easier to drive away
- Double piping Ø 5/7 mm + Ø 7 mm

Length 300 cm

904496 34,95

Length 400 cm

904497 39,95



**Magnet adapter set (3-part)**

For quick attachment of awning to vehicle. Awning can be securely attached to car with the magnetic strap.

1 pc. 901361 57,90



43,95

**Magnetic piping adapter set**

Quickly & easily attach awnings with a keder connection to a vehicle without a multirail. Consisting of magnetic tape with piping profile (length 283 cm) & 3 double piping rails, 90 cm each

1 set 904490 43,95

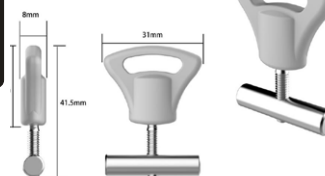
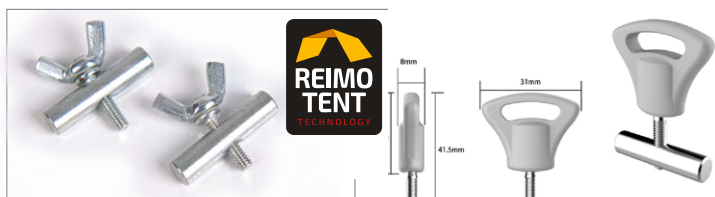

**Locking piece Keder rail - set of 2**

Prevents the keder strip from slipping out of the keder rail.

Ø 5 mm 901271 3,95

Ø 7 mm 901272 3,95

**Locking piece keder rail**

For piping strips with Ø 7 mm, fixes your awning, sun awning or similar.

2 piece 901273 7,50



**Travel Keder adapter**

For securely fastening your awning to the car. Double keder Ø 5+8 mm

Length 300 cm 904493 31,50

Length 400 cm 904495 34,95



31,50

**Awning attachment for vehicles with rain gutter**

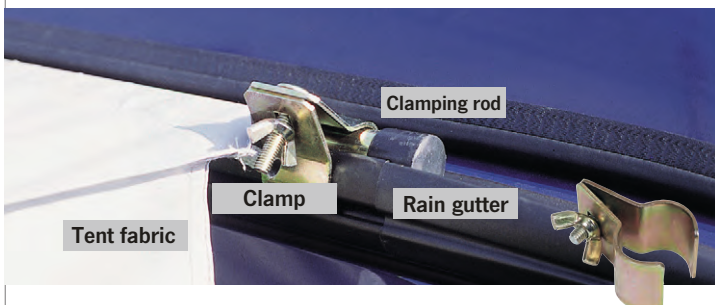

**Clamping rod/lock rod Ø 17 mm**

For mini campers, 255 cm long.

99444 8,40

**Metal pipe clamp,** with wing nut & screw. 2 piece Ø 22-25 mm

90300 4,40



10,60



**DoubleKeder rail**

Is hooked into the rain gutter on one side and the profile piping of the awning or tent is pulled in on the other side.

Gray, length 2.50 m

90120 10,60



# TENT PEGS, GROUND PEGS

## For soft soils (e.g. sand, meadow)



- ① **Half-round tent peg 10 pieces** Galvanized sheet steel. Width 19 mm. Length x thickness: 22 cm x 1,0 mm **90302 6,30**  
30 cm x 1,5 mm **90303 8,10**
- ② **Special herring extra strong plastic 6 pieces** flat head & additional eyelet, L 21,5 cm **94857 4,95**
- ③ **Soil nail with open eyelet 10 pcs.**

Galvanized steel.  
L 22 cm, Ø 4,0 mm **90270 3,30**  
L 24 cm, Ø 4,3 mm **90271 4,10**  
L 30 cm, Ø 4,3 mm **90272 3,70**

- ④ **Special plastic herring 6 pcs.** flexible, impact-resistant plastic,  
L 20 cm **94811 5,90**  
L 30 cm **94812 6,80**  
**ditto lose, 1 Stück**  
L 30 cm **94812L 0,99**

## For mixed soils (meadow with stones & dry soils)



- ⑤ **Trail-Mate tent peg** made of duralumin. **5 pieces** Length 18.5 cm; 1.5 mm thick. Weight 18 g.  
**94806 8,50**
- ⑥ **Soil nail in case, 20 pcs.** L 19,5 mm. Fluorizing for Cordless screwdriver **94815 28,60**
- ⑦ **Tent anchor/Tethering peg - With tether ring for pets** Ring Ø 8 mm, length 40 cm **90282 7,50**

## For hard soils (stones with meadow)



- ① **Soil nail with hook, 5 pcs.** attached hook. Galvanized steel. Ø 7 mm. L 21 cm **90273 5,90**
- ② **Tent peg Mammut, 2 pieces**  
Waved. Galvanized steel, 2 mm  
L 30 cm **94800 9,60**  
L 40 cm **94801 11,60**  
**Herring Mammut, lose, 1 Stück**  
L 30 cm **90267L 4,10**  
L 40 cm **90266L 4,70**

## For very hard soils (stones without meadow)

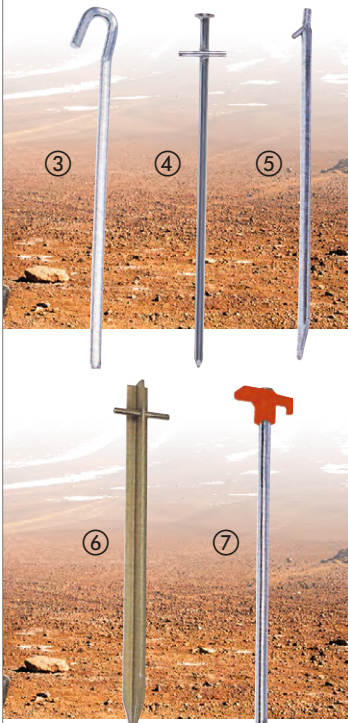

- ③ **Special grounding nail, triangular 5 pcs.** Galvanized steel, Ø 7 mm.  
L 23 cm **90274 6,60**  
L 30 cm **90275 9,99**
- ④ **Rock bottom herring Tarzan 5 pieces**  
With nail head & cross nail.  
Galvanized steel, round, Ø 6 mm.  
L 17 cm **903191 3,20**  
L 23 cm **903192 5,50**
- ⑤ **Tent peg Tyrol 5 pcs.** With cord pin, Galvanized steel 4 mm, B 11 mm.  
L 30 cm **94803 23,95**
- ⑥ **T-herring extra strong 2 pieces** Galvanized steel, 3 mm thick.  
W 20 x D 20 mm.  
L 30 cm **94804 16,60**  
L 40 cm **94805 13,80**  
**T-Herring lose, 1 Stück**  
L 40 cm **94805L 5,30**
- ⑦ **Rock nail 4 pieces** With plastic fastening hooks. Rock nail galvanized steel. Ø 7 mm, length 25 cm. **90299 16,50**



- Tox rock bottom herring 10 pcs.** sharp nail tip for easy penetration, Incl. L-BOXX Micro  
10 x rock ground peg Ø 6 mm made of galvanized steel  
L 17 cm **903193 14,99**  
L 23 cm **903194 15,99**



- L-Boxx Mini Camping Anchor Set (19 pieces)**  
For rooted, stony, frozen or clayey soils, incl. handy L-BOXX Mini  
6 x tent screw 220 cm with washer Ø 3,5 cm. 1 x TX40 bit, 1 x L-BOXX Mini.  
Dims.: W 26 x D 15.5 x H 6cm  
**94866 33,95**

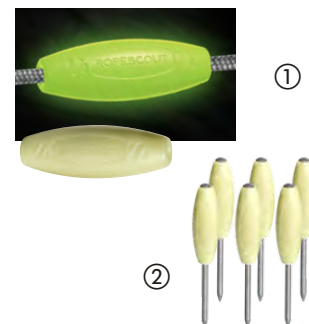

- ROPESCOUT: Luminescent markings**
- ① **Ropescout clips**, for ropes up to Ø 5 mm & wires up to Ø 4 mm, movable, quick & easy to clip on, weather-resistant  
set of 8 **94797 12,60**
  - ② **Ropescout Floor marker**  
set of 6 **94798 12,60**



- Soil nail set in case**  
L 19.5 mm. Fluorescent, for cordless screwdrivers  
**20 piece 94815 28,60**





① Parasol holder  
Ø 55 mm, for screwing into the ground.  
Length 55 cm **90325 22,50**

② Lawn spike  
Parasolholder for tube Ø from 22 - 37 mm.  
Length 50 cm **90314 7,95**

Guy ropes



① Tensioning line reflective 3 m  
Braided storm line with three-hole tensioner and pegging strap.  
Ø 3 mm, 3 m long, color: Green 4 pieces **90367 4,60**

② 50 m without three-hole clamp 1 roll **903672 9,95**

③ Tension line white 4 m  
Braided storm line with three-hole tensioner and peg strap. Ø 4 mm. 4 pcs. **90287 3,95**

from **3,95**

**REIMO TENT TECHNOLOGY**

Bracing aids



① Tent pegs with steel-hook and rubber loop  
4 piece **90284 3,95**

② Rubber tensioner with ball For quick and easy tensioning of tarpaulins, pavilions, awnings, etc. Universally usable! 5 piece **902841 3,45**

③ Rubber ring Square, hose-cut, L90 x B8 x H5 mm, 10 piece **90305 3,50**

④ Cord tensioner Alu with 3 holes, oval, hole Ø 5.3 mm. 10 piece **44223 3,40**

⑤ Cord tensioner Material: plastic, color: black. 10 piece **442231 2,95**

⑥ Nylon hook for screw mounting. 1 piece **44213 1,10**

⑦ Nylon hook special for boats & industrial use, fastening with knot on rubber rope Ø 8 mm. 5 pcs. **44212 4,90**

**NEW**

Bracing material



① Ladder tensioning element, gray  
6 sections, 21.5 cm cm long, 2.5 cm wide. 5 piece **90289 3,60**

② Rivet head tensioner Made of elastic plastic. For buttoning into punched eyelets. Pack of 5 pieces 11 cm long **90291 3,80**  
24 cm lang **902911 4,60**

③ Rubber tensioner 80-140cm stretchable with 2 aluminum hooks, Ø 10 mm **44218 2,50**

④ Jet Rope quick release Ratchet function, for tents, wind protection, as a washing line & much more. With 2 snap hooks. Usable length ca. 200 cm, loadable up to max. 30 kg. **936491 7,90**

⑤ Rubber tensioner Rubber cable with steel hook, 60 cm **44219 2,15**

⑥ Rubber cable with hook Rubber cable with plastic hook, 60 cm **44221 4,10**  
100 cm **44222 9,95**

⑦ Rubber clamps with metal hooks, Pack of 20 pieces  
Length 38 cm **442202 19,-**  
Länge 53 cm **442203 20,95**

from **2,15**

Luggage fastening

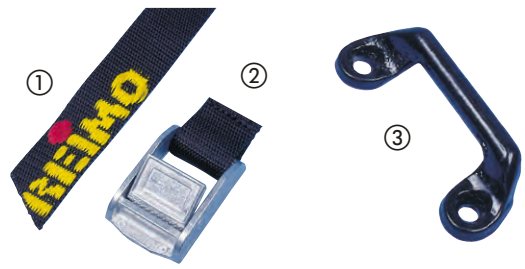

① belt, running meter, without buckle **29443 1,45**

② Buckle for the above belt **29442 2,40**

③ Metal locking clip 2 piece **29471 9,30**



# RAIN GUTTER HIGHRAIL



For piping Ø 7-8 mm

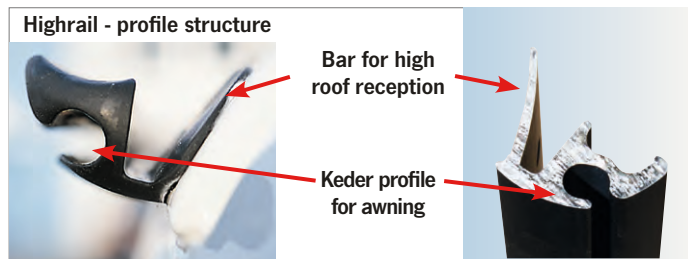

## Multifunctional rail Highrail with rain gutter - For high roof mounting Volkswagen T4/T5/T6

- Ideal for VW T4 (installation on T5/T6 by specialist company recommended)
- As a rain gutter and for attaching awnings or sun canopies
- Only permitted as a roof rack mount for VW T4
- Well suited as mount for high roof assembly (without end pieces) for Fiat Ducato, Peugeot Expert, Citroën Jumper with original bodywork
- Made of high-quality aluminium alloy, black anodized
- Front & rear parts (end pieces) made of PUR (polyurethane) create elegant transition to bodywork

Suitable for: Volkswagen T4/T5/T6

- |   |                     |
|---|---------------------|
| ① <b>Highrail Black</b>   |                     |
| Profile rail pre-drilled, black anodized. Accessories see end piece set                                     |                     |
| LR Profile length 3400 mm   | <b>901451 179,-</b> |
| ② <b>End piece set</b>  |                     |
| (Front spoiler and rear end incl. stainless steel screws black and silver as well as assembly instructions: |                     |
| For passenger side right,   | <b>90146 89,90</b>  |
| For driver's side left,   | <b>90147 80,90</b>  |

### Special adhesive - Sikaflex 554 -

- |   |                     |
|---|---------------------|
| 300 ml absolutely necessary for assembly!       |                     |
| Black. GP* 68,67 / 1 Liter                      | <b>294111 20,60</b> |
| Adhesive cleaner 0,25 Ltr. GP* 102,80 / 1 Liter | <b>29415 25,70</b>  |

Caution with special adhesives & adhesive cleaners

= Freight flat rate Highrail (1 - 10 pieces) **V25 25,90**

## Assembly

- Is screwed to the vehicle with stainless steel screws. In addition, glue the profile to the bodywork using the TÜV-approved special adhesive.
- The rail is available in several lengths, some of which are pre-drilled and countersunk.
- Separate end piece kit includes stainless steel screws and installation instructions.
- Special adhesive Sikaflex 554 (art. no. 294113) is required for installation.
- Use Sika adhesive cleaner (29415) or petroleum ether to degrease the bearing surface.

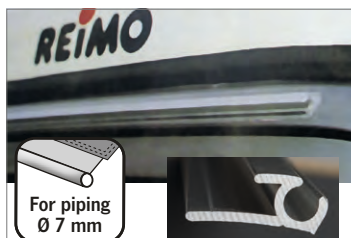

Rain gutter profile  
Suitable for:  
VW T4 FIAT Ducato

Aluminium, silver anodized. For vehicles without rain gutters such as VW T4, FIAT Ducato, etc. Can be used as a high roof support, for attaching sun canopies, etc. Supplied without screws (not required for mounting) and without adhesive (please order item no. 294105 separately).

3,40 m **90130 50,90**  
GP\* 14,97 / 1 m

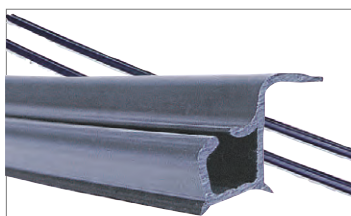

## Universal combination rain gutter

Integrated piping retraction rail for attaching bus awnings, sun canopies etc. to vehicles without rain gutters and to protect against rainwater run-off. Hard plastic with side sealing lips. Can be shortened individually. Black. Split down the middle. For piping thickness 5-8 mm. Delivery incl. 4 screws.

2,90 m GP\* 12,76 / 1 m **90113 36,99**  
3,25 m GP\* 10,46 / 1 m **90114 34,-**



## Universal rain gutter

- self-adhesive
- Water is drained away from door opening, so no more water drips into the vehicle interior when door is opened
- Can also be mounted in conjunction with Highrail

Special EPDM rubber profile for outdoor use in motor vehicles (automotive supplier quality). Permanently elastic and dimensionally stable. The length of 150 cm is sufficient for most vehicles without a rain gutter.

**46299 39,50**



**Montage:** The rain gutter 46299 has on the back a 6 mm wide double-sided 3M adhesive tape. Support surface clean and degrease with Sika adhesive cleaner or cleaning benzine. Peel off the protective film & press on, pressing firmly. Allow to cure for about 24 hours. Working temperature ca. 15 - 25 °C !



## Multirail - rain gutter, sun sail and roof rack attachment in one

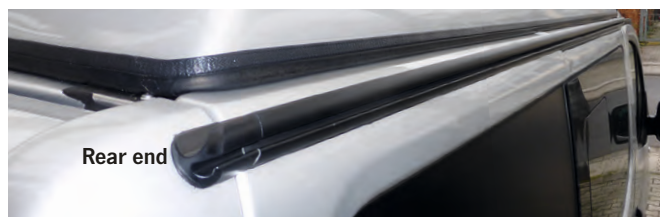

Water drainage via spoiler profile



Multirail - profile structure  
Gutter for clamping rod

Piping profile for awning

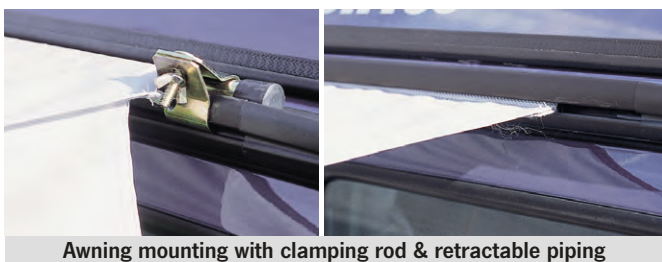

Awning mounting with clamping rod & retractable piping

**NOTE:** The matching spoiler set with screws and installation instructions must be ordered separately.



Spoiler set for Multirail VW/Mercedes/Citroën (90155)

- Rain gutter for canopy and roof rack
- Easy attachment of awning and awning with clamping rod or pull-in keder
- Easy installation of self-adhesive spoiler profiles
- The aluminum rail is already pre-drilled
- Support of roof loads up to 100 kg
- For piping thickness 7-8.5 mm

In conjunction with a conventional roof rack, you can use it to transport bulky goods such as kayaks, bicycles or surfboards. The Multirail can also be fitted to vehicles with sleeping or pop-up roofs. Here the maximum roof load is 50 kg, approved by VW. The Multirail protects you from rainwater run-off when the side windows and doors are open thanks to the spoiler profile (please order separately). The Multirail is attached to the vehicle with a special adhesive (Sikaflex 554, see below).

Vehicle type	Model	Multirail Art.No.	Price	Spoiler set* Art.No.	Price	
For Ford V710 > 2024 (2830 mm)	<b>NEW</b>	Short wheelbase right	90193	427,-	90154	69,60
		Short wheelbase left	901931	427,-	90155	69,60
For Volkswagen T4/T5/T6, special version	KR/SWB left (driver's side)	901561	256,-	90154	69,60	
	KR/SWB Right (passenger side)	90156	256,-	90155	69,60	
	LR/LWB Left/Right	90157	282,-	90154 links 90155 Right	69,60 69,60	
Für Mercedes Vito, Viano, V-Klasse, Marco Polo, Metris, Fahrzeuglänge 4990/5140 mm, alle ab 2003	Left (driver side)	901851	356,-	90154	69,60	
	Right (passenger side)	90185	356,-	90155	69,60	
For Renault Trafic, Nissan NV 300, Fiat Talento, from YOC. 8/2014 and Opel Vivaro B, year 8/2014 - 3/2019 all KR	Right (passenger side)	90184	255,-	901550	39,90	
For Citroën Spacetourer/Jumpy, Peugeot Traveller/Expert, Toyota Proace, all from 3/2016; Opel Vivaro C/Zafira Life from autumn 2019 & Pössl Campster/Vanster/Campy vehicle length 4950 mm	Left (driver's side)	901780	399,-	90154	69,60	
	Right (passenger side)	90178	399,-	90155	69,60	
Multirail Universal, can be shortened	Left or right	90153	199,-	901550	39,90	

= Plus Freight flat rate Multirail (1 - 10 pieces) V25 25,90

**VW Caddy piping rail for retracting awning or bus awning** Suitable for: Caddy YOC. 2003-2020

Fits for **Caddy YOC. 2003-2020** with & without sleeping roof. If sleeping roof is present, it only needs to be unlocked in order to pull piping into the rail. The plastic rail is glued in with Sikaflex 554. For piping Ø 7.5 mm Length 3 meters

- 901151 39,95
- ① Threading aid / end piece for piping rail plastic black 901152 9,95
- ② End piece / end cap for piping rail black plastic 901153 9,95

**Special adhesive - Sikaflex 554 - 300 ml absolutely necessary for assembly!**  
Black. GP\* 74,33 / 294113 22,30

**XAdhesive cleaner 0,25 Ltr. GP\* 102,80 / 1 Liter 29415 25,70**

\* Spoiler set consisting of front spoiler, rear end (self-adhesive), stainless steel screws and assembly instructions must be ordered separately.





# PEGGY PEG TENT & AWNING ATTACHMENT



## Screw pegs

- 5x lighter than a conventional metal herring, but 10x better grip (according to manufacturer)
- Ideal for soft, sandy soils due to compressing thread
- Can also be used on hard, stony floors thanks to height-adjustable hooks
- Very robust, made of glass fiber reinforced, UV-resistant polyamide or aluminum
- For hammering in with a hammer or for screwing in with a drill

- Peggy StartKit** 30 Peggys N 20 cm with 30 hooks, 20 Peggys S 12 cm plus combi tool and 2 PreDrills 6/10 mm, bag  
94836 79,95
- Peggy Small**  
12 Peggys S 12 cm, width across flats 17 mm, torque max. 5 Nm  
94837 17,70
- Peggy Hardcore**  
Set for hard floors. 4 Peggys Hardcore with 4 hooks, width across flats 17 mm  
94838 20,50
- Peggy Normal (Universal)**  
12 Peggys N 20 cm with 12 hooks, wrench size 17 mm, torque max. 25 Nm  
94839 24,50
- Peggy Peg screw peg**  
HeavyDuty set of 4, for hard stony ground.  
94862 45,-
- Peggy Peg lock nut 2.0**  
for retrofitting Peg&Stop screw pegs.  
94860 6,50
- Peggy Long**  
2 Peggys L 31 cm with 2 hooks, wrench size 17 mm, torque max. 30 Nm  
94840 17,70
- Peggy Long Alu**  
2 Peggys LA 31 cm long with 2 hooks, wrench size 17 mm.  
94841 26,50
- Peggy Peg Peg&Stop**  
set of 4, screw peg with lock nut.  
94864 13,99
- Bag for storage** 355 x 255 x 125 mm  
94842 10,50

**Fix&Go**



## ① Hardcore adapter

Suitable for all Peggy Peg pegs, compatible with T-handle of combi-tool. Width across flats 17 mm, torque max. 60 Nm

94835 8,20

## ② Peggy Peg Impact Tool HeavyDuty

Steel, screw socket 17 mm, for bit holder. Screw socket 17 mm for Peg&Stop Heavy Duty for steel bit holder. Impact wrench suitable.

94863 9,50

## ③ Peggy Peg combination tool, aluminum, for screw pegs.

Combines a hand wrench and an adapter for standard cordless screwdrivers. Suitable for all screw heads and screw pegs

94861 11,95



## Peggy Peg awning set

For attaching awnings/bag awnings/sun roofs/anchoring storm straps



**Contents** 6 Peg&Stop with lock nut 16 cm, 4 impact screw pegs HC 15 cm, 2 Peggys L 31 cm plus combi tool with aluminum adapter & 1 pair of Fix&Go anchor plate 2.0 with storm hook incl. storage bag (made of 100% polyester) (without strap).

94849 79,95



## Peggy Peg PreDrills

For extremely hard soils & especially in winter. Special PP masonry drill bit in 66 mm for screw peg  
2 piece 94847 10,70



## Peggy Peg Peg&Stop

Fiberglass-reinforced, infinitely height-adjustable screw peg with lock nut as a complementary product to Fix&Go anchor plate 2.0, 16 cm long.  
6 piece 94848 15,80



## Peggy Peg TieStraps

For additional tensioning of awnings & bag awnings in bad weather in order to relieve joint arms.  
Per piece 94846 13,50



## Signal storm band

Band is easily visible in the twilight. Suitable for awnings and tents for storm protection.

**Scope of delivery:** belt two-piece, 13 m, adjustable, 2 relief springs  
94832 21,95





**Fix&Go Tube - Flexible ballast tank**

Ideal extension of the Fix&Go anchor plate for setting up the awning on Pavement, concrete or asphalt. Fix&Go Tube is light & compact & becomes an additional weight of 10 kg. Application: The adapter shoe onto a Fix&Go anchor plate on awning base. Hose with 10 liters Fill with water and place in the basket, then attach with Velcro straps to the Attach awning leg. One Fix&Go tube per side provides 20 kg of ballast to use the awning even in light winds.

Attention: Fix&Go Tube does not replace an awning attachment to the ground!

**Fix&Go Tube, 1 piece** **94853** **19,90**

**set of 2 Tube Pavilion:** Design like Fix&Go Tube, but without adapter shoe. Simply attach to gazebo leg with Velcro. **948531** **31,50**



**U-Connector**

The TieStrap can be connected to the Crocodile Peggy using the U-Connector. This means that tarpaulins etc. can also be tensioned to the ground with the TieStrap. Two TieStraps, for example, can also be connected together and thus extended.

**94854** **8,-**



**Silicone strap**

The SiliconStrap is the spare part for the Fix&Go AntiFlap attachment. But you can also use it to quickly tie a cable together, etc. A useful little helper in our system.

**94855** **7,-**



**PetPeg 2.0**

- Ground anchor with shock absorber for leashing dogs, cats etc.
- Material: recycled stainless steel
- Useable in wide range of floors.
- Flexible height adjustment means pulling force is always close to ground and PetPeg remains firmly anchored

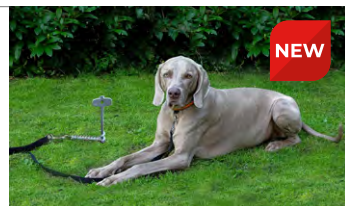

**NEW**

- Jolt damper prevents the leashed animal from injuring itself through its own force
- Suitable for animals up to ca. 45 kg

**94865** **35,50**



**Peggy Peg Fix&Go AntiFlap**

This awning clamp reduces the annoying "flapping noise" almost completely. Widely projecting awnings can be tightened even better with several AntiFlap's per side. Fix&Go AntiFlap is compatible with almost all awning systems, whether with round, oval or square rafter poles.

**Contents:** 2 Fix&Go AntiFlap, additionally needed: 2 rafters of awning manufacturer.

**94851** **39,90**



**Peggy Peg Uni plate set of 4**

For fastening tent carpets or similar. Holds material to the ground without perforating it

**Scope of delivery** 4 plates **94830** **10,60**



**Peggy Peg Anchor plate 6 pcs**

Universal mounting plates **Scope of delivery** 2 anchor plates, 2 storm hooks, 2 Uni plates

**94831** **19,-**



**Crocodile Peggy Set**

Multifunctional, infinitely adjustable, powerful quick-release clamps

4 pcs. **94833** **16,-**  
25 pcs. **94834** **99,95**



**Croc adapter set of 4**

Pull into welt rail and can be used to hang coat hangers or other items. Together with Crocodile Peggy can also be attached a tension belt.

4 pcs. **94845** **7,50**



**Peggy Peg Fix&Go Bridge**

- Dist. between anchor plate & floor increased by 2 cm
- Water can flow unhindered
- Stackable inside each other for greater floor clearance
- Naturally also for fine sandy surfaces

Content: 2 Fix&Go Bridges.

**94850** **8,40**

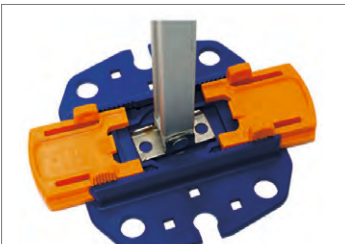

Secure fixing of awning feet and tent poles, no sinking into soft ground or lifting off. The retraction of awnings is possible. For all screw pegs from Peggy Peg.

**94828** **14,-**



**Peggy Peg Fix&Go adapter buffer**

- Fixing pole awnings, sun awnings etc. with Ø 18-27 mm Inner diameter
- Fits perfectly with Anker plate 2.0
- Insert buffer at the end of the rod & tighten

**94858** **9,95**

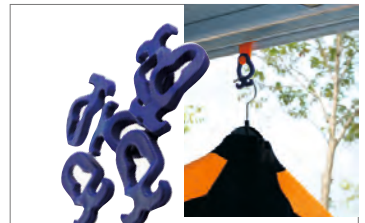

**Peggy Peg hook**

Individual hooks to match the Peggy Peg screw peg.

**L set of 4** L/LA/HP (31cm/15cm version).  
4 piece **94843** **5,-**

**N Set of 6** Peg screw peg N (20cm standard version).  
6 pieces **94844** **4,50**



# ZELT ZUBEHÖR, AUFBEWAHRUNG



## 1A Mosquito nets - 5 meters

- Particularly dense, very stable design

Provides reliable protection against mosquitoes & bugs. Reimo also uses this quality for its own sleeping and lifting roofs. Rot-proof plastic fabric. No return of yard goods. Flame-retardant black version.

5 x 1.45 m Black **56019** **71,95**



## Protective bag for pegs

Material: 100% polyurethane  
Color: silver

Dims. (LxØ): 73 x 44 cm

**919252** **9,95**

## Drawstring bag set

Material: 100% polyester in blue,  
3 bags each in format: 40 x 29 cm,  
29 x 20 cm, 20 x 14 cm

**919253** **13,95**



## No equipment should be without this

- Camping hatchet.** Length ca. 34 cm, weight ca. 630 g  
**94825** **15,90**
- Multifunctional shovel**  
Shovel, wrench, bottle opener, knife, saw. Practical bag included. Material: shovel head: high-quality steel/handle: aluminum alloy
- Folding spade with saw**  
2-fold folding, painted steel. Pack size 270/170/40 mm.  
**90349** **19,95**

Dims.: Shovel head 9.4 x 12cm/total product length 37cm. Weight: 0.5 kg  
**903511** **17,95**

**NEW**

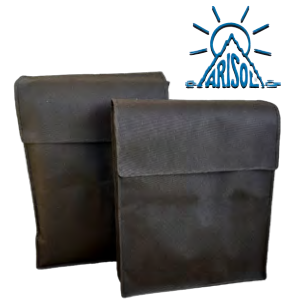

## Storage bag for tent carpets

- with air-permeable mesh on the side

Color: Black

**Storage Bag L** 48 x 40 x 13,5 cm  
**Storage Bag XL** 54 x 38 x 16 cm

**919256** **7,99**  
**919257** **8,99**

## Tent sewing thread

Sewing thread schappe-spun, cross-wound,  
100% polyester



Roll 200 m

Blue **94906** **6,50**  
Grey **94908** **6,50**  
White **94909** **6,50**

Roll 500 m

Brown **94911** **8,95**  
Grey **94912** **8,95**



## Till - Frame bag

- With zipper
- With carrying handle

Material 100% polyester (600D)  
Color: black

Dims.: L120 x W25 x H25 cm

**91929** **18,95**

## Carry - Carry bag

- With carrying handle



Material 100% polyester in black  
Dimensions: L 140 x Ø 23 cm

**919297** **15,95**

**15,95**



## Tent hammer + peg extractor

- Rubber mallet with wooden handle**  
with herring extractor, 250 g  
**94823** **3,95**
- Herring extractor luxury**  
Galvanized steel, with plastic handle.  
Piece **90324** **2,50**
- Telescopic Herring extractor, easy on the back,**  
extendable up to 60 cm  
**903241** **5,95**



**Rubber tent hammer**  
with peg extractor, 190 g  
**94824** **9,40**









**Lashing point round**  
Plastic, 10 pieces  
44309 0,95



**Lashing hook**  
45x39 mm  
Plastic, 10 pieces  
44310 2,50



**LOXX safety press studs by Hindermann**  
The clever security push-button with triggering self-locking mechanism for almost all applications and extreme loads. set of 2 **373831 24,50**  
set of 5 **373830 39,-**



**LOXXpress**  
studs 5 pieces for fastening fabrics to wood, sheet metal etc. (e.g. for boat decks etc.). Button only unlocks after lifting the canopy, very wind-resistant. Silver, nickel-plated  
**37383 21,50**  
Black **37384 34,75**



**Press studs for fabric/sheet metal**  
Fastening of fabrics to sheet metal or wood, can be screwed on. Incl. Tool. Brass and silver-colored. Ø 15 mm, 10 pieces  
**56230 18,94**



**Press studs for fabric/fabric**  
For fabric to fabric connections. Incl. Tool. Brass silver-colored Ø 15 mm, 10 pieces  
**90214 12,95**



**Push locks**  
Special version for garments. Incl. Tool. Ø 15 mm  
10 pcs. **90215 12,95**



**Eyelet set Ø 8 mm**  
Like 90210,  
Brass silver-colored, 24 pcs.  
**90216 11,90**



**Eyelet set Ø 11 mm**  
For awnings and awnings,  
brass 15 pcs. incl. tools  
**90210 11,90**



**Eyelet set Ø 14 mm**  
Version as 90210 10 pcs.  
incl. tool  
**90211 14,95**



**Eyelets 4 mm silver**  
Brass, 4 mm, 50 pcs.  
Color: silver, incl. tool.  
**90811 8,95**



**Eyelets and washers**  
Brass, 4 mm, 50 pcs.  
Color: brass, incl. tool.  
**90810 9,95**



**Eyelets and Washers**  
Brass, 14 mm, 10 pcs.  
Color: burnished, incl. tool  
**90812 15,95**



**Eyelets and washers**  
Brass, 14 mm, 10 pcs.  
Color: silver, incl. tool.  
**908120 15,95**



**Plastic eyelets**  
No special tools required.  
Ø 15 mm, black. 12 piece  
**90212 7,90**



**Rivets 9 mm**  
Brass, 9 mm, 24 pcs.  
Color: silver, incl. tool.  
**90809 12,95**



**Velcro tape**  
self-adhesive  
Color black, 2x 60 cm  
(adhesive & fleece side)  
**90813 6,90**



**Craft needles**  
One upholstery/leather/  
tent/carpet and bag needle  
each Color: silver, 5 pieces  
**90814 6,90**



**Multi-purpose pliers**  
Perfect riveting of press studs & eyelets, length ca. 20 cm  
**90209 18,95**



**Twist locks**  
With eyelets, washers & self-tapping screws, nickel-plated brass. For secure & easily detachable fastening 33 mm.  
4 pcs. **90217 18,95**



# TENT REPAIR / TENT MAINTENANCE



**Tent cleaner**  
Cleaning and impregnation. Also for parasols and clothing; breathable. 1000 ml **61409 24,95**  
Hazard: H225, H315, H319, H304, H336, H411, EUH066



**Awnings cleaner**  
for natural and synthetic fabrics 1000 ml **61417 21,40**  
Warning: H315, H319



**Impregnating concentrate**  
4-fold Impregnating concentrate for all canopies, awnings, awnings, sunshades & similar fabrics. Simply with four times the amount of water dilute and impregnate the fabric. Prevents mildew stains and mold. Solvent free. 1000 ml **61445 28,60**



**Silicone spray 300 ml**  
For easier running of zippers, to protect rubber and plastic parts. 300 ml (GP\* 35,67 / 1 Liter) **29421 10,70**  
Hazard: H225, H317, H319, H410



**Seam seal with brush**  
Ready-to-use seam sealer in a practical brush tin. Seals all seams and makes leaking seams waterproof again 100 ml **61447 15,80**  
GP\* 158,00 / 1 Liter  
DANGER: H225, H315, H319, H335, H336, H411, EUH066



**Seam-tight**  
Seals water-repellent and weather-resistant, makes leaky seams in tents, awnings, tarpaulins or clothing waterproof again. Hardwearing, with long-lasting effect 100 ml **61446 11,-**  
GP\* 110,00 / 1 Liter  
DANGER: H225, H319, H336

**Awning and awning cleaner**  
Special cleaner for awnings and awnings. Removes dirt and stains. Refreshes faded colors. Content: 650 ml  
For DE, GB, DK **61604 9,90**  
For ES, IT, FR **616041 9,90**  
For FI, SE, NO **616042 9,90**  
(GP\* 15,23 / 1 Liter)



**Waterproofing spray with PTFE**  
Impregnates tents and awnings. Makes the fabric water repellent. Protects material from wind and weather. PTFE coats the surface w/ a protective layer. Content: 650 ml  
For DE, GB, DK **61605 15,90**  
For FI, SE, NO **616052 15,90**  
(GP\* 24,46 / 1 Liter)  
Danger: H304, H373, EUH066



**Repair kits for tent fabrics**  
Self-adhesive, mat: 100% polyamide Color: Atlantic blue, dims.: ca. 12 x 20cm 2 pcs. **900990 6,10**  
5 differ. large tent repair patches. Self-adhesive, mat: 100% polyamide Color: Light grey **900992 6,10**  
Tent repair patches for ironing on. Mat: 100% cotton, waterproof, colorfast, color: sand **900991 6,10**

**Zippers in the category Interior fittings**

**Repair kit PVC & acrylic for tent fabric and foil** In 2 versions. Scl. and transparent. For sealing holes and cracks. With reinforcement cord for cracks. Type A Acrylic **900981 18,95**

**Ultimate Xtreme Clean**  
The ultimate Cleaning agent for every purpose and every surface. For cleaning vinyl, plastic and even inflatable boats  
For ES, IT, FR **616191 10,90**  
For FI, SE, NO **616192 10,90**  
(GP\* 16,77 / 1 Liter)  
Danger: H290, H318



**Xtreme Clean**  
ULTIMATE CLEANING AGENT FOR EVERY PURPOSE AND EVERY SURFACE. For cleaning vinyl, plastic and even inflatable boats. **Danger**



**Lubricant spray with Teflon**  
For zippers and everything that squeaks. 300 ml **96038 15,95**  
GP\* 53,17 / 1 Liter  
Danger: H222, H229



**Zip/ piping pull-in spray**  
To make zips run smoothly or to make it easier to pull in piping (awnings). Prevents moving parts from squeaking. Makes stuck parts move again. 200 ml **61450 13,20**  
GP\* 66,00 / 1 Liter  
Danger: H222, H229, H315, H326, H411



**Mould remover**  
Thoroughly and automatically removes mould and mildew stains from all types of fabrics. At the same time odour and protects against new infestation. 500 ml **61440 13,90**  
GP\* 27,80 / 1 Liter  
Danger: H290, H314, H400, H412, EUH031, EUH206



## Folding vacuum cleaner for wide range of applications

- Suction holder 100% stainless steel, suction plate Ø12 cm
- 100% natural rubber
- Anti-slip rubber plate with torsion brake

### Privacy screen in 2 versions: Flexible or Rigid

Both versions are supplied with Suction holders, Stainless steel support arms, gray polyester curtain & rubber curtain fixation

① **Flexible privacy screen:** The two suction plates can be rotated very flexibly. This means they can be in almost any position when assembled. Length of bar with suction holder 90 cm, weight ca. 6 kg



66550 339,-

### ② Rigid privacy screen:

This privacy screen is suitable for straight side walls. The suction plates are firmly attached. Width ca. 80 cm

66551 262,-

### ③ Clothesline - Ideal for traveling

Clothesline is quick to assemble & you can always choose sunny side to attach it to. The holders can also be used individually for different applications.

**Scope of delivery:** 2x suction holder, 8 meter line, rope tensioner Weight ca. 1.9 kg

66547 159,-



Made of high-quality stainless steel, seawater-resistant



### Hood table

Suitable for most base vehicles. This table is attached to hood using suction cups. The panel is then brought into the straight position using the height adjustment and fixed in place.

#### Scope of delivery:

Universal table top "Crespo", dims.: 42.5 x 42.5 cm, suction holder with table attachment. Height-adjustable support leg connection that can be adapted to the slope. Weight: ca. 2.2 kg

66549 144,-



### Awning bracket - set of 2

The stainless steel bracket is fitted with a plastic holder that matches the awning. The original bracket from the respective manufacturer guarantees a 100% fit. Weight ca. 1500 gr.

For Thule	66562	161,-
For Fiamma	66563	164,-
For Dometic	66564	179,-



### New, innovative Suction holder system: base support + exchangeable adapter plates

The base support with natural rubber suction plate is connected to the selected adapter plate without screws. The possible applications of the various adapter plates are almost unlimited. e.g. Clothesline, towel holder, shower holder etc.

① Base carrier	66575	45,95
② Shower holder adapter	66576	24,95
③ Universal adapter	66577	21,95

## Practical miniFolding suction cup, Ø 5.5 cm

45,95

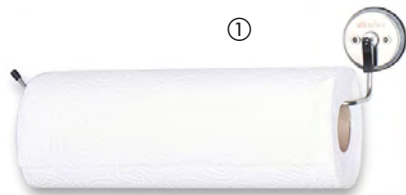

### ① Roll holder

This holder also holds on the surfaces of the Porta Potti and can be attached to the side, for example. Base body: Aluminum

For kitchen rolls 66544 45,95



### ② Universal holder

- Versatile use e.g. towel and clothes rack
- For hanging a wide variety of utensils
- Base body: Stainless steel

66597 49,95



### Shower holder

For easy installation on all smooth surfaces. Push the shower head straight into the rubber holder or pull it straight out. Base body: Stainless steel

③ Rigid 1 pc.	66539	47,-
④ Rotatable 1 pc.	66561	57,-





# ORGANIZER FOR TENTS, CARAVANS & MOTORHOMES



5,95

## Hook rail with 4 hooks

Easy way to hang up jackets, towels and other items in awnings, caravans or awnings. Simply slide into the piping rail. 8 hooks, length 15 x height 6 cm.

903272 5,95

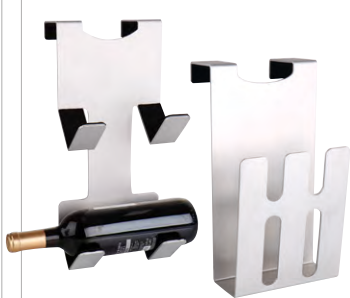

## Brackets in elegant aluminum design

For hanging in caravan windows and doors up to a thickness of 6 cm. The hooks are lined with felt, gentle on surfaces - practical for handy storage. Material: matt anodized aluminium, sturdy design.

- ① **Magazine holder**  
W17 x H31.5 x D7 cm  
495893 39,95
- ② **Bottle holder**  
W17 x H36.5 cm  
495895 39,95

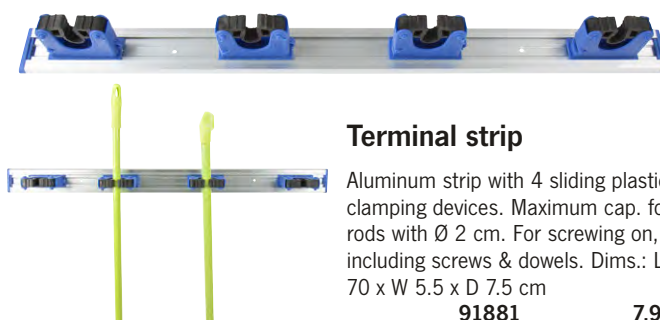

## Terminal strip

Aluminum strip with 4 sliding plastic clamping devices. Maximum cap. for rods with Ø 2 cm. For screwing on, including screws & dowels. Dims.: L 70 x W 5.5 x D 7.5 cm

91881 7,90



19,95

## FeltSeat organizer

For driver or passenger seat With retaining strap on armrests and hook for fastening under the seat Large bag also suitable for laptop Material felt, color anthracite Dims.: W42 x H76cm.

919172 19,95

All prices without decoration!



## Hook rail with 8 hooks, piping + Velcro fastener

Hook rail for awning, caravan or awning. Velcro at the back for tent pole or 7 mm piping. Material 600D Oxford, 8 plastic hooks, length 58 x height 20 cm.

903271 6,95



## set of 2 Metal hook

Versatile use, e.g. for hanging utensil silos. Length 13 cm

919240 1,95

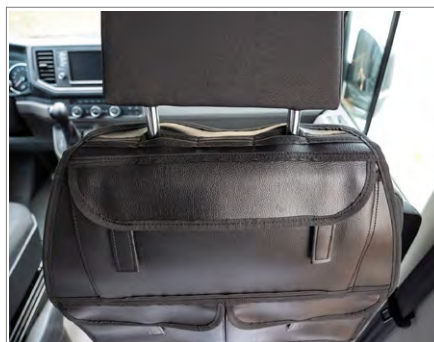

## Organizer for cabin seats

- Holding mat with 4 pockets for the back of the back of driver's and passenger's seats
  - Secure hold thanks to attachment with eyelets (on headrest) and 4 elastic bands
  - Universal use thanks to adjustable attachment to armrest, seat and headrest
  - Chic faux leather look in black and gray-black colors
- Holding mat with 4 firmly attached pockets.  
Dims.: 1 x 32 x 20 cm, 2 x 21 x 19 cm, 1 x 44 x 28 cm. Pockets are closed with Velcro. Weight ca. 0.8 kg.

- ① **Color:** Black - Grey  
919167 46,90
- ② **Color:** completely black  
919180 46,90



You can find more organizers in Household category



Wall/Tent organizer

small and practical storage, with 2 eyelets or piping profile for fastening.  
Color: Grey-mottled



①



① HOLIDAY TRAVEL - 1  
1 bag W 20 x H 20 cm  
919273 6,95

②



② HOLIDAY TRAVEL - 2  
2 bags W 40 x H 20 cm  
919274 9,95

③



③ HOLIDAY TRAVEL - 3  
3 pockets W 60 x H 20 cm  
919275 11,95



④

④ HOLIDAY TRAVEL - Schuh-Organizer  
für 12 Paar Schuhe  
B 48 x H 86 cm,  
919279 34,95



⑤



⑤ HOLIDAY TRAVEL - Folding box  
Foldable for small pack size  
• 2 boxes with carrying handles  
• Boxes can be used separately  
• Connecting the boxes with Velcro  
• Floor w/ Velcro for a secure stand in the trunk  
• with shelf for stable support  
L 50 x H 30 x W 30 cm, material: polyester  
919280 24,95

⑥



⑥ HOLIDAY TRAVEL - Mini  
4 pockets W 20 x H 60 cm  
919278 11,95

⑦



⑦ HOLIDAY TRAVEL - Maxi  
8 bags in different sizes. W 40 x H 60 cm  
919277 16,95

⑧



⑧ HOLIDAY TRAVEL - Grande  
Many bags in different sizes. partly with flap.  
W 40 x H 75 cm,  
919276 19,95

Organizer-Tessa Black/Lime



from 4,95

Tessa 1 wall organizer

With one pocket and 2 eyelets,  
dims.: W x 20 x H x 20 cm  
919262 4,95



Tessa 2 wall organizer

With two pockets and 2 eyelets,  
dimensions: W 40 x H 20 cm  
919263 6,95



7,95

Tessa Mini Organizer

With four pockets and 2 eyelets,  
new color combination:  
black/lime,  
Dimensions: W 20 x H 57 cm.  
919269 7,95



Tessa Maxi Organizer

With 8 pockets in different  
sizes. With 2 eyelets,  
loops or piping profile  
for hanging.  
Dims.: W x 40 x H 60 cm.  
919266 13,95



Shoe organizer

For 12 pairs of shoes with 2 eyelets and straps for fastening to  
walls or doors. Material: Polyester. Dims.: W x 48 x H 86 cm,  
weight ca. 1.4 kg. Color: Black/Lime  
919255 29,95



14,95

Tessa Grande Organizer

With many pockets in  
different sizes. With 2  
eyelets, loops or piping  
profile for hanging.  
Dimensions:  
W 40 x H 75 cm.  
919265 14,95







### FIAMMA Organizer

Organize the items with style

The new Fiamma organizers in an engaging and modern design. A new room layout & introduction, supplemented with additional new functional elements such as mesh pockets (Organizer S, Organizer Seat and Toiletry) & a lower pocket with double compartment (Organizer S) make it possible to make ideal use of the space.

#### ① Organizer S

Dims.: W 50 x H 84 cm Weight: 0.4 kg  
**441781 39,70**

#### ② Organizer L

Dims.: W 88 x H 39 cm, weight: 0.5 kg  
**441782 34,-**

#### ③ Seat organizer

Dims.: W 43 x H66 cm, weight: 0.3 kg  
**441784 27,50**



### Shoe organizer

- Waterproof, hinged container
- Simple suspension
- With 10 pockets

Open: W 54 x H 84 x D 2 cm

**441783 48,-**



### Bathroom organizer

- With hooks for attaching to doors, windows, etc.
- Weather resistant and waterproof
- With 10 pockets

Opened: W 30 x H 118 x D 11 cm, Closed: W 30 x H 37 x D 11 cm

**441785 39,90**



### Pack Organizer Mix

- Suitable for any location
- Made from polyester fabric
- Pop-up closure for minimum space requirement when closed

Practical storage container for a variety of items such as toys or laundry. The 4 bag clips supplied also allow it to be used as a waste garbage can. Dims.: Ø 28 cm x H 40 cm, weight: 0.3 kg

**440472 52,70**

### Pack Organizer Box

Extremely practical and spacious bag that is versatile and takes up very little space when folded. Dims.: W 60 x H 36 x D 31 cm  
 Weight 2,5 kg

**44432 77,20**



### Carry Rail clothes rail

In an elegant design. Anodized aluminium tube, stainless steel & pieces. Length 100 cm, can be shortened.

**44183 68,50**





39,-



**Thule Bath Kit Organizer**

- Space-saving organizer for storing your bathroom utensils
- With L-shaped hook for attaching to doors, windows, etc.
- Weather resistant and waterproof

Perfect for small rooms. Toilet set for the whole family. Lots of pockets for storage space. Additional pockets for first aid items. Carrying handle to take the set with you to the washrooms.

92703 39,-

**Wall mounting for Utensils**

- For screwing on
- Ideal for Thule Utensil bags

2 piece 92799



49,-



49,95

**Thule Trash Bin, foldable waste garbage can 50 liters**

Large container for collecting waste. Foldable for space-saving storage. Zipper on the underside for easy emptying. Dimensions: 35 x 35 x 70 cm. Color: Black / Grey

927010 49,95

**Thule Countertop Organizer**

Water resistant. Dimensions: 90 x 40 cm. Color: Black / Turquoise 927073 39,-



**Shoe organizer**

For up to 10 pairs of shoes. Attachment to the POD system, stabilized by Velcro fasteners and additional press studs. (PODs not included.) Color: Black/Turquoise Dimensions: W 50 x H 85 cm

92702 49,95



**Thule GoBox**

Water resistant. Color: Black/Turquoise

**Thule GoBox Medium**  
Dims.: 61 x 36 x 30 cm.

927071 81,-

**Thule GoBox Large**  
Dims.: 61 x 46 x 30 cm.

927072 113,-

**Organizer**

- Attachment to piping, driver's seat or rods
- Generously height-adjustable for individual requirements
- Very robust
- Reinforced back panels
- Incl. Carrying handle

Material: Cotton Touch  
Color: Silver grey/black

NEW



**① Shoe Organizer**

- 10 compartments for shoes, 3 small mesh comp. at top, 2 large mesh pockets on side
- Cover can be rolled upwards
- With 2-way zipper
- Loadable up to 8 kg

Dimensions: open: W 49 x D 35 x H 79 cm  
folded: W 49 x D 2 x H 79 cm

927031 69,95

**② Multifunctional organizer**

- Organizer with magnetic fasteners
- Loadable up to 8 kg

Dimensions: open: W 50 x D 13 x H 81 cm  
folded: W 50 x D 4 x H 31 cm  
Compartment size: 13 x 23 cm

927032 59,95

**③ Organizer Chunky**

- 9 compartments, 5 extra mesh compartments
- 2-way zipper
- Loadable up to 8 kg

Dimensions: open: W 80 x D 24 x H 89 cm  
folded: W 80 x D 2 x H 46 cm

927033 64,95







**Patio-Mat and Patio Mat Light- The ideal addition for awnings and awnings**

- With loops for pegs
- Continuous hem

The Fiamma Patio-Mat, the reliable companion on the road. The beautifully shaped & easy to repair polypropylene mesh is 100% breathable & feels very comfortable to walk on, especially barefoot.

The Patio-Mat is fire-retardant & resistant to UV rays, easy to repair if damaged & retains its color & structure.

The mesh is printed on both sides and can therefore be used on both sides. There are also practical loops at the corners for fastening with pegs.

**Patio Mat Light:**

- Lighter material
- Bag included
- Without border
- Unicolored

**NEW**

Patio Mat Light



Size	Dimensions	Awning	sqm	Weight	Art. no.	Price	Base price per m <sup>2</sup>
290	290 x 250 cm	300 - 310	7,25	2,2 kg	440589	63,-	GP*8,69/qm
340	340 x 250 cm	350 - 360	8,5	2,6 kg	440590	67,90	GP*7,99/qm
390	390 x 250 cm	400 - 410	9,75	2,9 kg	440591	74,90	GP*7,68/qm
440	440 x 250 cm	440 - 450	11,25	3,3 kg	440592	81,60	GP*7,42/qm

**Patio Mat**

- Bag optionally available
- Mwith border

Patio Mat

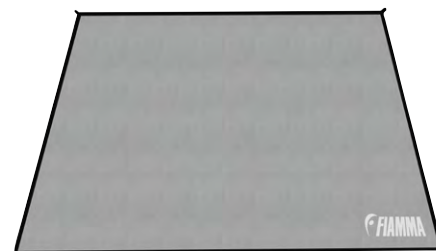

Size	Dimensions	Awning	sqm	Weight	Art. no.	Price	Base price per m <sup>2</sup>
260	260 x 250 cm	260 - 280	6,5	2,5 kg	904150	98,70	GP*15,18/qm
290	290 x 250 cm	300 - 310	7,25	3,2 kg	904149	105,-	GP*14,48/qm
340	340 x 250 cm	350 - 360	8,50	3,5 kg	904144	111,-	GP* 13,06/qm
390	390 x 250 cm	400 - 410	9,75	3,8 kg	904146	126,-	GP*12,92/qm
440	440 x 250 cm	440 - 450	11,00	4,2 kg	904147	140,-	GP* 12,73/qm
490	490 x 250 cm	490 - 500	12,25	4,6	904148	157,-	GP*12,82/qm
540	540 x 250 cm	540 - 550	13,75	5,1 kg	440588	162,-	GP*12,00/qm

<b>Optional bag for Patio-Mat:</b>	90 x 35 x 16 cm	<b>904140</b>	<b>14,30</b>				
------------------------------------	-----------------	---------------	--------------	--	--	--	--





### Awning and awning carpet - TRAVEL

Particularly light and compact

- Protects against cold ground, stones and dirt
- Material: 100% polypropylene (PP)
- Material thickness: 200 g/m<sup>2</sup>
- Breathable
- Washable
- Mold resistant
- Durable
- 100% recyclable
- Easy to clean
- Incl. Carrier bag



Width 250 cm	Weight	Art. no.	Price	Base price per m <sup>2</sup>
L 260cm	ca. 1,3 kg	<b>904335</b>	<b>51,95</b>	GP*7,99/qm
L 290cm	ca. 1,5 kg	<b>904336</b>	<b>54,95</b>	GP*7,58/qm
L 320cm	ca. 1,7 kg	<b>904337</b>	<b>59,95</b>	GP*7,49/qm
L 370cm	ca. 1,9 kg	<b>904338</b>	<b>67,95</b>	GP*7,35/qm

### Optional accessories:

Fixing clips - set of 4

For attaching carpets, awnings, tarps and much more. Simply clip in, close and secure. For material thickness up to max. 1.2 cm

Material: PP

Dims.: L8.5 x W3 cm

4 piece

**904489**

**4,50**



**4**  
PIECES



without tarpaulin and pegs





Width 250 cm	① Villa Ethno		
L 290 cm	90516	54,95	GP* 7,58/qm
L 390 cm	905161	69,95	GP* 7,17 /qm
L 450 cm	905162	79,95	GP*7,11/qm
L 500 cm	905163	89,95	GP*7,20/qm
L 600 cm	905164	99,95	GP*6,66/qm

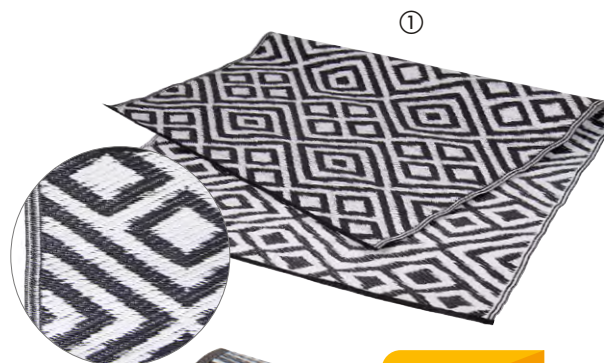

Width 250 cm	② Villa Stripes		
L 290 cm	90517	54,95	GP* 7,58/qm
L 390 cm	905171	69,95	GP* 7,17/qm
L 450 cm	905172	79,95	GP* 7,11/qm
L 500 cm	905173	89,95	GP* 7,20/qm
L 600 cm	905174	99,95	GP* 6,66/qm

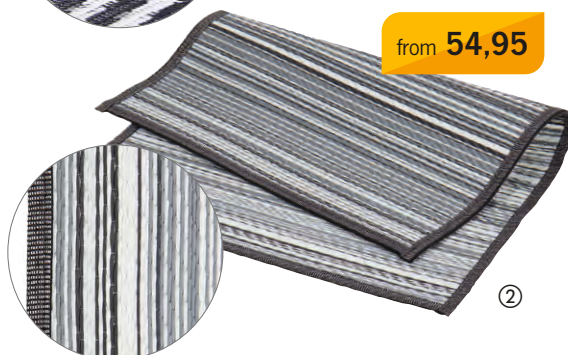

Particularly thick and insulating material

## VILLA ETHNO + STRIPES - Awning / tent carpets in premium quality

- Material: 100% PP
- Material thickness: 400 g/m<sup>2</sup>
- Extra thick, protects against cold floors
- Incl. Carrier bag
- Durable
- Rot-proof
- Easy to clean
- Border edged
- Can be used on both sides
- Abreathable

Width 250 cm	① Cloud gray		
L 300 cm	905151	44,95	GP* 5,99/qm
L 350 cm	905152	49,95	GP* 5,71/qm
L 400 cm	905153	59,95	GP* 6,00/qm
L 450 cm	905154	69,95	GP* 6,00/qm
L 500 cm	905155	74,95	GP* 6,00/qm
Width 300 cm			
L 400 cm	905156	74,95	GP* 6,25/qm
L 500 cm	905157	79,95	GP* 5,33/qm

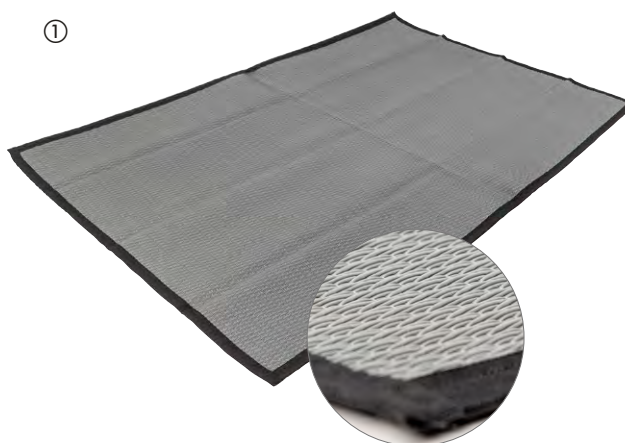

## CLOUD awning / tent carpet in classic gray or black with white accents

- Low weight
- Material: 100% PP
- Material thickness: 300 g/m<sup>2</sup>
- Incl. Carrier bag
- Durable
- Easy to clean
- Border edged
- Can be used on both sides

The CLOUD awning / tent carpet is particularly soft and protects against cold ground, stones and dirt. It can be used on both sides, has a bordered edge & a loop at each corner to attach it to the floor.

Width 250 cm	② Cloud black		
L 300 cm	905184	44,95	GP* 5,99/qm
L 350 cm	905185	49,95	GP* 5,71/qm
L 400 cm	905186	59,95	GP* 6,00/qm
L 450 cm	905187	69,95	GP* 6,22/qm
L 500 cm	905188	74,95	GP* 6,00/qm



All rugs are supplied in a bag



Sizes ideal for camper vans





**Our awning and awning carpets**

- Particularly thick and soft
- Protects against cold ground, stones and dirt
- Material: 100% polypropylene (PP),
- Material thickness: 400 g/m<sup>2</sup>
- With UV protection, breathable

- Border edged
- Hard-wearing, rot-proof
- Easy-care, particularly easy to clean
- Loops at all corners for securing with pegs, e.g.
- Carrying bag included

**HOLIDAY TRAVEL**

Color: Anthracite

Width 250 cm	Weight ca.	Item no.	Price	Base price per m <sup>2</sup>
L 260 cm	2,6 kg	905194	49,95	GP*7,68/qm
L 290 cm	3 kg	905195	54,95	GP*7,58/qm
L 340 cm	3,5 kg	905196	59,95	GP*7,05/qm
L 390 cm	4 kg	905197	69,95	GP*7,17/qm



**LIFE IS A JOURNEY**

Color: Light grey

Width 250 cm	Weight ca.	Item no.	Price	Base price per m <sup>2</sup>
L 260cm	2,6 kg	905189	49,95	GP*7,68/qm
L 290cm	3 kg	905190	54,95	GP*7,58/qm
L 340cm	3,5 kg	905192	59,95	GP*7,05/qm
L 390cm	4 kg	905193	69,95	GP*7,17/qm



**Optional accessories:**

**Plastic tarp nails - 6 pieces**

- With a broad head
- For fastening tent carpets, floors, tarpaulins, etc.
- Simply insert through eyelets
- No more tripping hazards and risk of injury

Color: Gray  
 Material: Plastic  
 Dimensions: 8 cm  
 6 piece

902801 2,40

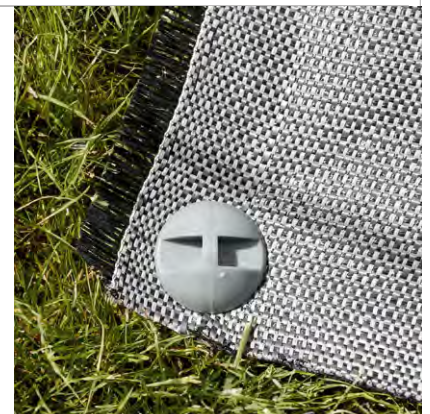



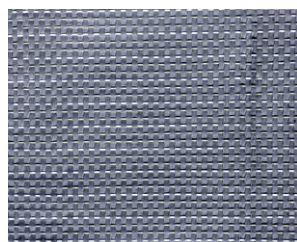
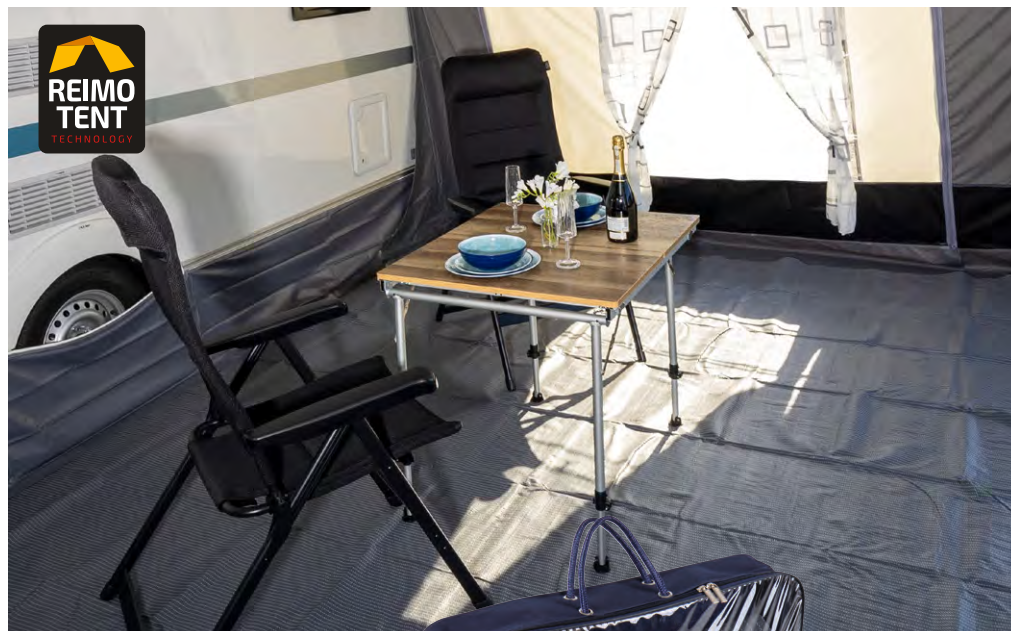

from 93,95

**VILLA SOFT LIGHT**  
Anthracite - The timeless awning carpet for sand and gravel

- Material: 70% PVC, 30% Textilene, thickness 400g/m<sup>2</sup>
- Carrying bag included
- Indestructible synthetic fiber
- Specially coated
- Durable and easy to clean
- Rot-proof and UV-resistant
- 4 corner eyelets
- Can be cut to size
- Very comfortable barefoot

Width 2.5 m

Length	Price	Base price
6,0 m	905013 99,95	GP* 6,66/qm

Width 3.0 m

Length	Price	Base price
5,5 m	905014 104,95	GP* 6,36/qm
6,0 m	905015 114,95	GP* 6,39/qm
6,5 m	905016 93,95	GP* 4,82/qm
7,0 m	905017 102,-	GP* 4,86/qm



**VILLA ECO - Tent carpet**  
for grass floors

- Permeable to air
- Material: 100% polyamide, UV resistant, high tear resistance
- Material thickness: 500g/m<sup>2</sup>
- Incl. Carrier bag
- Cozy and warm underfoot with high walking comfort

Width 2.5 m

Length	Grey	Price	Base price
3,0 m	90402	45,95	GP* 6,13/qm
3,5 m	904020	52,95	GP* 6,05/qm
4,0 m	904021	62,95	GP* 6,29/qm
4,5 m	904022	64,95	GP* 5,53/qm
5,0 m	904023	69,95	GP* 6,00/qm
6,0 m	904024	89,95	GP* 6,00/qm
30 m (whole roll only) x 2.5 m	905020	379,-	GP* 5,05/qm







**VILLA SOFT DELUXE - The hard-wearing awning carpet**

- Material: 70% PVC, 30% Textilene
- Material thickness: 480g/m<sup>2</sup>
- incl. carrying bag
- Indestructible synthetic fiber
- Specially coated
- Durable and easy to clean
- Rot-proof

- UV-resistant
- Can be cut to size
- Very comfortable barefoot
- Abreathable

**Villa Soft Deluxe Graywidth 2,5 m**

Length	Price	Base price
3,0 m	90504 62,90	GP* 8,39/qm
4,0 m	905041 82,90	GP* 8,29/qm
5,0 m	905042 95,90	GP* 7,67/qm
6,0 m	905043 114,90	GP* 7,66/qm

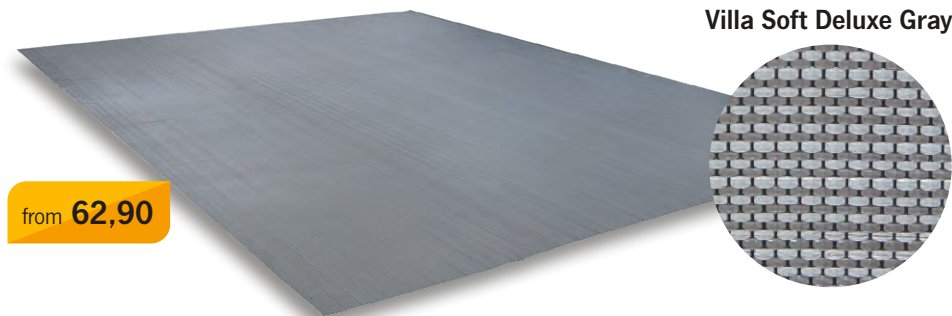

Villa Soft Deluxe Gray

**Villa Soft Deluxe Graywidth 3,0 m**

Length	Price	Basic priceprice
5,5 m	905044 125,90	GP* 7,63/qm
6,0 m	905045 134,90	GP* 7,49/qm
6,5 m	905046 154,90	GP* 7,94/qm
7,5 m	905047 164,90	GP* 7,33/qm
8,0 m	905048 186,90	GP* 7,79/qm

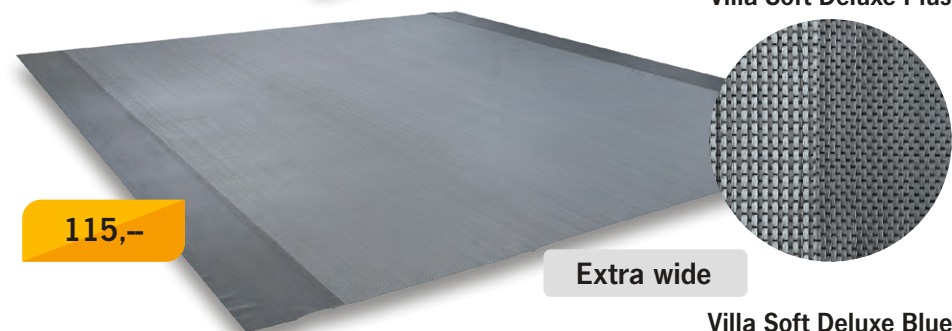

Villa Soft Deluxe Plus

**Villa Soft Deluxe Plus Gray/anthracite, width 3,5 m**

Length	Price	Basic priceprice
5,0 m	905051 115,-	GP* 6,57/qm

**Villa Soft Deluxe Blue, width 3.0 m - for large awnings**

Length	Price	Base price
8,0 m	904167 97,50	GP* 4,06/qm

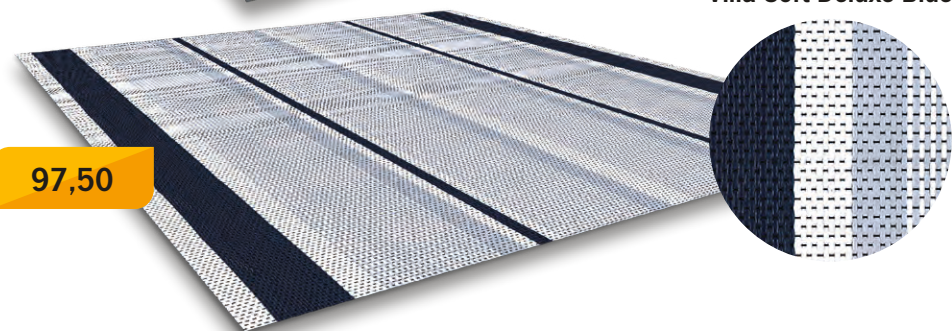

Villa Soft Deluxe Blue

**Awning carpet DAWN + FLINT**

- Framed incl. corner eyelet
- Suitable for many canopies and awnings
- Made in Europe (designed in Denmark)
- Made in Sweden and Denmark
- Environmentally friendly & manufactured free from phthalates
- Very easy to clean
- Durable and robust
- Waterproof
- Flame retardant
- UV-resistant
- Small packaging size



The Isabella awning carpet consists of the hard-wearing IsabellaCarpet, which is edged on all sides and fitted with an eyelet at each corner. Manufactured in Sweden under the highest environmental standards - phthalate-free and with 100% renewable energy - it is further processed in Denmark and meets all requirements for the camping sector. A pleasant feeling underfoot is a matter of course!



**DAWN (dark gray, depth 250 cm)**

Width	Weight	Item no.	Price	Base price
270 cm	3,7 kg	945285	119,-	GP*0,00/qm
320 cm	4,3 kg	945286	139,-	GP*0,00/qm
370 cm	5,0 kg	945287	159,-	GP*0,00/qm
420 cm	5,8 kg	945288	179,-	GP*0,00/qm



**FLINT (light gray depth 250 cm)**

Wide	Weight	Item no.	Price	Base price
330 cm	4,4 kg	945289	139,-	GP* 139,-/qm



# AWNING CARPETS

## SAFARI - The elegant tent carpet classics from Italy

- Motorhome awning carpet
- 100% polypropylene, recyclable
- Easy to clean
- Lightweight and durable
- Including carrying bag and Accessories for attaching the carpet (6x clips and pegs)

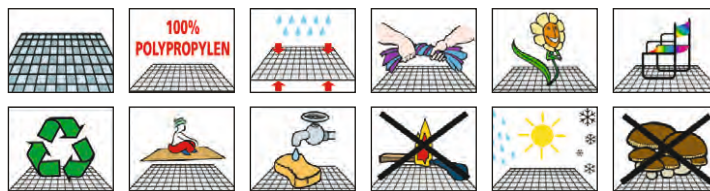

Material thickness: 200 g/m<sup>2</sup>. Width 250 cm:

L 300 cm	<b>904015</b>	<b>34,50</b>	GP* 4,60/qm
L 350 cm	<b>904016</b>	<b>43,50</b>	GP* 4,97 /qm
L 400 cm	<b>904017</b>	<b>44,50</b>	GP* 4,45/qm
L 450 cm	<b>904018</b>	<b>52,50</b>	GP* 4,44 /qm
L 500 cm	<b>904019</b>	<b>55,50</b>	GP* 4,44/qm



from **34,50**

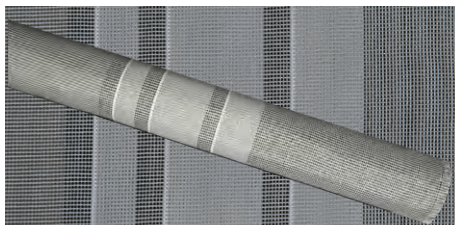

## Arisol tent carpets incl. 6 fastening clips, 6 pegs and carrying bag

- Breathable and hard-wearing
- Lightweight, space-saving and washable
- UV and water resistant
- Smooth surface and dense fabric
- Carrying bag included



Dirt can be easily swept away. Carpet individually packed. Material: 100% polypropylene.



① Standard blue

from **54,95**



② Standard dark gray



③ Luxury gray

**Standard carpet for normal wear** Material thickness: 300 g/m<sup>2</sup>.

Width 250 cm	① Blue		
L 300 cm	<b>904302</b>	<b>54,95</b>	GP* 7,33/qm
L 350 cm	<b>904312</b>	<b>59,95</b>	GP* 6,85/qm
L 400 cm	<b>904272</b>	<b>66,90</b>	GP* 6,69/qm
L 450 cm	<b>904282</b>	<b>72,90</b>	GP* 6,48/qm
L 500 cm	<b>904212</b>	<b>79,-</b>	GP* 6,00/qm
L 600 cm	<b>904222</b>	<b>89,95</b>	GP* 6,00/qm
Width 300 cm			
L 500 cm	<b>904328</b>	<b>99,95</b>	GP* 6,66/qm
L 600 cm	<b>904329</b>	<b>119,-</b>	GP* 6,61/qm
L 700 cm	<b>904330</b>	<b>129,-</b>	GP* 6,14/qm

**Luxury carpet for heavy-duty use** Material thickness: 500 g/m<sup>2</sup>.

Width 250 cm	② Dark gray		
L 300 cm	<b>904322</b>	<b>59,50</b>	GP* 7,93/qm
L 350 cm	<b>904323</b>	<b>61,20</b>	GP* 6,99/qm
L 400 cm	<b>904324</b>	<b>66,90</b>	GP* 6,69/qm
L 450 cm	<b>904325</b>	<b>72,90</b>	GP* 6,48/qm
L 500 cm	<b>904326</b>	<b>79,95</b>	GP* 6,40/qm
L 600 cm	<b>904327</b>	<b>96,50</b>	GP* 6,43/qm
Width 300 cm			
L 500 cm	<b>904332</b>	<b>99,95</b>	GP* 6,66/qm
L 600 cm	<b>904333</b>	<b>119,-</b>	GP* 6,61/qm
L 700 cm	<b>904334</b>	<b>129,-</b>	GP* 6,14/qm

Width 250 cm	③ Gray		
L 300 cm	<b>90448</b>	<b>59,-</b>	GP* 6,74/qm
L 400 cm	<b>904481</b>	<b>80,95</b>	GP* 8,10/qm
L 500 cm	<b>904483</b>	<b>99,45</b>	GP* 7,96/qm
L 600 cm	<b>904484</b>	<b>109,-</b>	GP* 6,71/qm

**Additional accessories:**  
 6x fastening clips **904486 6,50**  
 6x pegs **904487 5,40**





## Isabella Carpet - Environmentally conscious and without harmful substances

Isabella Carpet is produced in Sweden without harmful substances under highest environmental standards using 100% renewable energy.

It can be cut to size in all directions (without fraying), is hard-wearing, UV-resistant, flame-retardant, waterproof & packs up small. In terms of weight, attention was paid to achieving good balance between weaving weight & the lowest possible transport weight.

In 99% of all cases, this tent carpet can only be cleaned with clear water and a brush. A pleasant feeling under your feet is of course a matter of course!

### Design North width 250 cm

L 300 cm	94521	98,-	GP* 13,07/qm
L 400 cm	94522	117,-	GP* 11,70/qm
L 500 cm	94523	150,-	GP* 12,00/qm
L 550 cm	94524	161,-	GP* 11,71/qm
L 600 cm	94525	177,-	GP* 11,80/qm
L 650 cm	94526	188,-	GP* 11,57/qm
L 700 cm	94527	204,-	GP* 11,66/qm
L 800 cm	94528	232,-	GP* 11,60/qm
Roll 50 m	94520	1107,-	GP* 8,86/qm

### Design North width 300 cm

L 300 cm	945212	111,-	GP* 12,33/qm
L 400 cm	945222	142,-	GP* 11,83/qm
L 500 cm	945232	177,-	GP* 11,77/qm
L 550 cm	945242	190,-	GP* 11,52/qm
L 600 cm	945252	209,-	GP* 11,61/qm
L 650 cm	945262	225,-	GP* 11,54/qm
L 700 cm	945272	245,-	GP* 11,67/qm
L 800 cm	945282	279,-	GP* 11,62/qm
Roll 50 m	945202	1519,-	GP* 10,13/qm

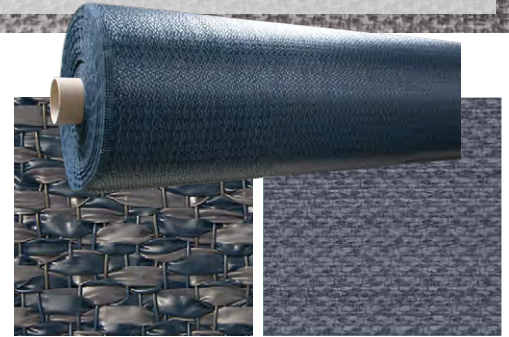

**NORTH** is reminiscent of the dark blue of the sea.

### Design Dawn width 250 cm

L 300 cm	945211	98,-	GP* 13,07/qm
L 400 cm	945221	117,-	GP* 11,70/qm
L 500 cm	945231	150,-	GP* 12,00/qm
L 550 cm	945241	161,-	GP* 11,71/qm
L 600 cm	945251	177,-	GP* 11,80/qm
L 650 cm	945261	188,-	GP* 11,57/qm
L 700 cm	945271	204,-	GP* 11,66/qm
L 800 cm	945281	232,-	GP* 11,60/qm
Roll 50 m	945201	1107,-	GP* 8,86/qm

### Design Dawn width 300 cm

L 300 cm	945214	111,-	GP* 12,33/qm
L 400 cm	945224	142,-	GP* 11,83/qm
L 500 cm	945234	177,-	GP* 11,80/qm
L 550 cm	945244	190,-	GP* 11,52/qm
L 600 cm	945254	209,-	GP* 11,61/qm
L 650 cm	945264	225,-	GP* 11,54/qm
L 700 cm	945274	245,-	GP* 11,67/qm
L 800 cm	945284	279,-	GP* 11,62/qm
Roll 50 m	945204	1519,-	GP* 10,13/qm

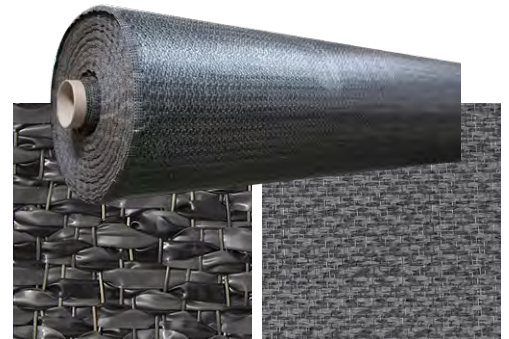

**DAWN** is reminiscent of a landscape in the morning mist

### Design Flint width 250 cm

L 300 cm	94530	98,-	GP* 13,07/qm
L 400 cm	94531	117,-	GP* 11,70/qm
L 500 cm	94532	150,-	GP* 12,00/qm
L 550 cm	94533	161,-	GP* 11,71/qm
L 600 cm	94534	177,-	GP* 11,80/qm
L 650 cm	94563	188,-	GP* 11,57/qm
L 700 cm	94564	204,-	GP* 11,66/qm
L 800 cm	94565	232,-	GP* 11,60/qm
Roll 50 m	94529	949,-	GP* 7,59/qm

### Design Flint width 300 cm

L 300 cm	945213	111,-	GP* 12,33/qm
L 400 cm	945223	142,-	GP* 11,83/qm
L 500 cm	945233	177,-	GP* 11,80/qm
L 550 cm	945243	190,-	GP* 11,52/qm
L 600 cm	945253	209,-	GP* 11,61/qm
L 650 cm	945263	225,-	GP* 11,54/qm
L 700 cm	945273	245,-	GP* 11,67/qm
L 800 cm	945283	279,-	GP* 11,62/qm
Roll 50 m	945203	1519,-	GP* 10,13/qm

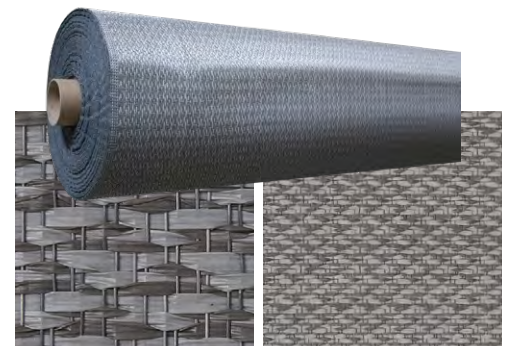

**FLINT** is reminiscent of flint as a material.

PHTHALATE  
**free**  
Isabella Carpet



ECO FRIENDLY



CUTS W/O FRAYING



FLAME RETARDANT



LOW WEIGHT



UV RESISTANT



VERY COMFORTABLE



WATER RESISTANT



EASY TO HANDLE



HIGH DESIGN



EASY TO CLEAN



## TENT CARPETS/ALL-PURPOSE TARPAULINS



### Water protection tarpaulin

- Material: 100% PVC
- Dry awning in heavy rain

This practical groundsheet prevents water from entering the tent. 4 separately inflatable air tubes at the edges allow the water to simply flow past and the inside of the tent remains dry.



### Water protection tarpaulin, color grey

Wide	Length	Weight	Item no.	Price	Base price
2,5 m	2,5 m	3,1 kg	904467	47,90	GP* 7,66/qm
2,5 m	3,0 m	3,6 kg	90446	55,95	GP* 7,46/qm
2,5 m	4,0 m	4,5 kg	904465	73,95	GP* 7,40/qm
2,5 m	5,0 m	5,4 kg	904466	79,95	GP* 6,40/qm
3,0 m	4,0 m	5,1 kg	904468	54,95	GP* 4,58/qm
3,0 m	5,0 m	6,1 kg	904469	69,95	GP* 4,66/qm



Caution: Do not overfill the air hoses



### All-purpose tarpaulins

Versatile tarpaulin, e.g. as a tarpaulin to protect against dirt and rain or as a windbreak. Size suitable as carpet pad for tent carpets. With welded-in reinforcement cord, eyelets and reinforced corners. Waterproof and UV-stabilized.

**Material:** PE fabric 125g/m<sup>2</sup>

**Color:** Gray

**Dimensions:**

Width	Length	Art. no.	Price	Base price
2 m	3 m	90660	9,95	GP* 1,66/qm
3 m	3 m	90661	13,50	GP* 1,50/qm
3 m	4 m	90662	15,50	GP* 1,29/qm
3 m	5 m	90656	14,95	GP* 1,00/qm
3 m	6 m	90657	16,95	GP* 0,94/qm
3 m	7 m	90658	17,95	GP* 0,85/qm
3 m	8 m	90659	18,95	GP* 0,79/qm



### Tarpaulin - Tent floor carpet pad or all-purpose tarpaulin

- Eyelets at 1 meter intervals
- Waterproof and UV-stabilized
- Reinforced corners

Versatile use as a tarpaulin for protection or as a tent floor. PE fabric 170 g/sqm.

**Color:** Blue

Wide	Length	Weight	Item no.	Price	Base price
4 m	5 m	3,6 kg	90653	19,50	GP* 0,97/qm
4 m	6 m	4,4 kg	90654	29,95	GP* 1,25/qm
5 m	6 m	5,5 kg	90655	37,95	GP* 1,27/qm





6  
PIECES



**Plastic tarp nails - 6 pieces**

- With a broad head
- For fastening tent carpets, floors, tarpaulins, etc.
- Simply insert through eyelets
- No more tripping hazards and risk of injury

Color: Gray,  
Material: Plastic  
Dimensions: 8 cm,

6 piece    902801    2,40



4  
PIECES

Without tarpaulin and pegs



4,50



**Fixing clips - set of 4**

For attaching carpets, awnings, tarps and much more. Simply clip in, close and secure. For material thickness up to max. 1.2 cm

Material: PP  
Dims.: L8.5 x W3 cm  
4 piece

904489    4,50

4  
PIECES

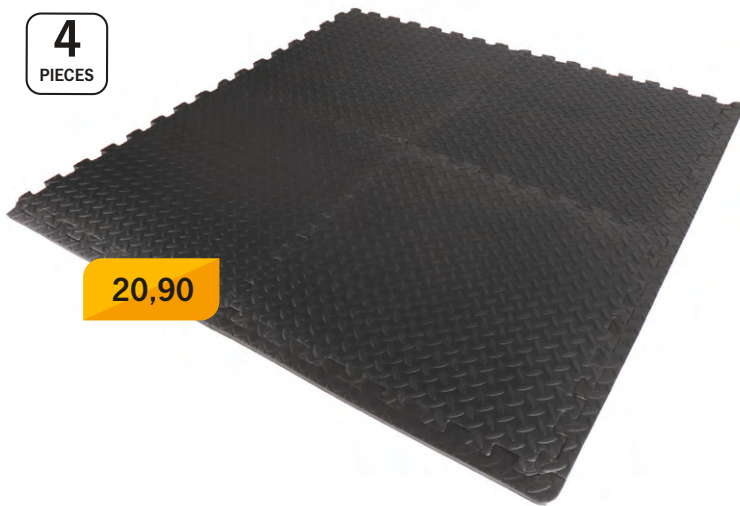

20,90

**Floor tiles - 60 x 60 cm**

- Universally applicable
- Including corner strips
- Soft, shock-absorbing material
- Mounted quickly

For tents, awnings, awnings, playgrounds, hobby rooms, children's rooms, etc. No more cold & wet feet. Soft, shock-absorbing and insulating material. Can be cut to size with scissors or a knife.

Material: EVA  
4 tiles and 8 corner strips    90445    20,90



4,35



**Ikafloor - The easy-care floor for permanent tents**

**A hit for seasonal and permanent campers:** A level floor, a flat-lying carpet and no rising cold in the spring and fall.

**Installation is very simple!** No tools are required as the elements have locking pins and can be connected like building blocks.

**The individual element measures 50 x 50 x 3,5 cm.** Low weight, size adjustment possible with a saw.

IsabellaFloor can be used with or without a carpet overlay.

Corner    904353    4,35  
Sloping front    904355    12,50

