





# MULTIMEDIA

**CARBEST** 

## Smart TV of new generation

- Android operating system
- WiFi, DVB-S2 (SAT), DVB-C (cable), DVB-T2 with HD (terrestrial)
- Wide viewing angle
- Extremely slim housing with depth of 42 mm
- Screen mirroring
- Can also be operated via smartphone app
- Suitable for 12V / 24V and 230V systems

9~30 VOLT	100~240 VOLT	DVB-T2 DVB-S2 DVB-C	H.265 DVB-T2
HDMI	USB 2.0	CI+ SLOT	MPEG4
WIFI	FULL HD	VIDEO TEXT	EPG



Further information on page 831

Devices type	21.5" FULL HD	23.8" FULL HD
Screen format	16:9 widescreen format	
Viewing angle	178 / 178	178 / 178
Operating voltage	12V DC / 24V DC / 230V AC	
TV connections IN	2x HDMI, AV-in, 2x USB, 1x CI+ slot, RJ45, TV tuner (1x DVB-T2, 1xDVB-T-S2)	
TV connections OUT	1x coaxial, 1x headphone	
Power consumption operation/standby	36 W / 0,5 W	
Resolution (pixels)	1920x1080	1920x1080
Contrast	4000:1	3000:1
Brightness (cd/m2)	180	180
Energy efficiency	E	E
Dims. (mm): without base, WxHxD	494 x 293 x 42	542 x 322 x 42
Dims. (mm): With base, WxHxD	494 x 342 x 180	542 x 371 x 180
Weight (without foot)	2,5 kg	2,7 kg
Scope of delivery	LED TV, stand, remote control, mains adapter 100-240V, car adapter 9V - 30V with cigarette lighter plug, instructions	
Item no. / Price	<b>49900 229,-</b>	<b>49901 259,-</b>

We reserve the right to make technical improvements or changes and to supply a product of comparable quality from another manufacturer or supplier. The images are similar to delivered products. Dimensions without guarantee.

LED & Smart TVs.....	830 – 836
TV and monitor mounts .....	837 – 841
Compact DVB-T2 antennas.....	842
SAT flat antennas.....	843 – 845
SAT systems.....	846 – 855
Portable dome antennas.....	856 – 857
LTE/WiFi antennas.....	857 – 864
HD-sticks/SAT-Finder.....	864

Cable entries & antenna accessories.....	865 – 867
Rear view systems & cameras.....	868 – 874
Navigation systems.....	875 – 876
Naviceivers, infotainers & accessories.....	877 – 879
Navigation infotainment systems .....	880 – 881
Car radio accessories.....	882
Loudspeakers & sound systems.....	883 – 885



# Smart TV – powered by Android

- For an all-round multimedia experience
- WiFi, DVB-S2 (SAT), DVB-C (Cable), DVB-T2 with HD (Terrestrial)
- Wide viewing angle
- Extra slim housing
- Android operating system
- On/off switch on the device
- Frame width 12 mm

- |           |              |                           |                 |
|-----------|--------------|---------------------------|-----------------|
| 9~30 VOLT | 100~240 VOLT | DVB-T2<br>DVB-S2<br>DVB-C | H.265<br>DVB-T2 |
| HDMI      | USB 2.0      | CI+ SLOT                  | MPEG4           |
| WIFI      | SCART<br>VGA | VIDEO<br>TEXT             | HEVC<br>10 bit  |

**FULL HD**  
from 21.5"

**3\***  
YRS. WAR-  
RANTY

Devices type	18.5" HD READY	21.5" FULL HD	23.6" FULL HD	27" FULL HD
Screen format	16:9 widescreen format			
Viewing angle	178 / 178	176 / 176	178 / 178	178 / 178
Operating voltage	12V DC / 24V DC / 230V AC			
TV connections IN	1x HDMI, 2x USB 2.0, 1x VGA, 1x PC audio, 1x CI+ slot, 1x AV, 1x RJ45			
TV connections OUT	1x coaxial, 1x headphone			
Power consumption operation/standby	<36 W / <0.5 W			<48 W / <0.5 W
Resolution (pixels)	1366 x 768	FULL HD 1920 x 1080		
Contrast	3000:1	4000:1	3000:1	3000:1
Brightness (cd/m2)	200	200	200	240
Energy efficiency	F	F	F	F
Dims. (mm): w/o. base, WxHxD	436 x 259 x 43	502 x 297 x 45	551 x 327 x 43	638x379x45/62
Dims. (mm): w/ base, WxHxD	436 x 304 x 160	502 x 342 x 160	551 x 369 x 180	638x416x187
Weight (without foot)	1,9 kg	2,3 kg	2,8 kg	3,8 kg
Scope of delivery	LED TV, stand/feet, power supply 100-240V, car adapter 12-30V with cigarette lighter plug, remote control, manual			
Item no. / Price	49881 269,-	49883 299,-	49885 349,-	49886 399,-

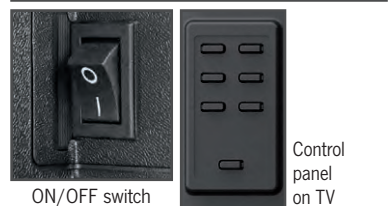

We reserve right to make technical improvements / changes, as well as to supply a qualitatively comparable product from another manufacturer or supplier in each case. The images are similar to delivered products. Dimensions without guarantee.

\* You can find our warranty conditions on pg. 1096.





# Smart TV of new generation

- For an all-round multimedia experience
- Android operating system
- WiFi, DVB-S2 (SAT), DVB-C (cable), DVB-T2 with HD (terrestrial)
- Wide viewing angle
- Extremely slim housing with 42mm depth
- Screen mirroring
- Can also be operated via smartphone app
- With time shift
- Suitable for 12V / 24V and 230V systems
- Frameless housing, lower frame part made of brushed stainless steel in matt black
- Frame width 3 mm



9~30 VOLT	100~240 VOLT	DVB-T2 DVB-S2 DVB-C	H.265 DVB-T2
HDMI	USB 2.0	CI+ SLOT	MPEG4
WIFI 2.4 GHZ	FULL HD	VIDEO TEXT	EPG

Devices type	21.5" FULL HD	23.8" FULL HD
Screen format	16:9 widescreen format	
Viewing angle	178 / 178	178 / 178
Operating voltage	12V DC / 24V DC / 230V AC	
TV connections IN	2x HDMI, AV-in, 2x USB, 1x CI+ slot, RJ45, TV tuner (1x DVB-T2, 1xDVB-T-S2)	
TV connections OUT	1x coaxial, 1x headphone	
Power consumption operation/standby	36 W / 0,5 W	
Resolution (pixels)	1920x1080	1920x1080
Contrast	4000:1	3000:1
Brightness (cd/m2)	180	180
Energy efficiency	E	E
Dims. (mm): w/o. base, WxHxD	494 x 293 x 42	542 x 322 x 42
Dims. (mm): w/ base, WxHxD	494 x 342 x 180	542 x 371 x 180
Weight (without foot)	2,5 kg	2,7 kg
Scope of delivery	LED TV, stand, remote control, mains adapter 100-240V, car adapter 9V - 30V with cigarette lighter plug, instructions	
Item no. / Price	49900 229,-	49901 259,-

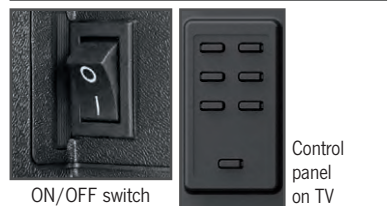

We reserve right to make technical improvements / changes, as well as to supply a qualitatively comparable product from another manufacturer or supplier in each case. The images are similar to delivered products. Dimensions without guarantee.

Available from Q2/2025

\* You can find our warranty conditions on pg. 1096.



# Oyster® Smart TV

POWERED BY **Avtex**



Sizes :  
19"  
21,5"  
24" 27"

- High-end device with ultra-flat design
- integrated 2.4 GHz and 5 GHz WLAN
- WLAN setup with WPS (compatible WLAN source required, e.g. Oyster® Connect, Oyster® Access and Oyster® EasyNet)
- Bluetooth 5.1
- Built-in tuner for DVB-S2, DVB-T2 tuner HD/H.265
- VIDAA operating system
- Web browser
- HbbTV ("Hybrid broadcast broadband TeleVision")

- Multiple favorite channel lists (e.g. for D, AT, CH etc.)
- WIDI/Miracast
- OTA (Over-The-Air-Update - software update via Internet)
- Connectable via USB 2.0 and HDMI
- Freely nameable signal inputs
- Universal installation w/ VESA standard bracket
- System remote control: only one remote control for satellite system and Oyster® Smart TV set
- EPG electronic program guide w/ 7-day preview
- ON-SCREEN display for supply voltage
- "Audio only" function
- Barrier-free use
- CI / CI+ module slot
- Sturdy construction for mobile use in motorhomes & caravans
- Pre-programmed channel lists for D/AT/CH/FR and update support from ten Haaft
- Power switch On / Off
- Type approval mark according to KBA

Super class technology. Classic television and computer functions in one device. Bring the world of the Internet to your TV screen. Whether watching TV or streaming - with new smart TV series from Oyster® you have the allround package on board.



\*Energy consumption in on-state in kWh per 1,000 h when playing SDR content, rounded to the nearest whole number.

ten Haaft TV sets	Oyster® Smart TV 19"	Oyster® Smart TV 21.5"	Oyster® Smart TV 24"	Oyster® Smart TV 27"
EU energy efficiency	E	E	E	E
Screen size	19" / 48 cm	21.5" / 55 cm	24" / 61 cm	27" / 69 cm
Annual energy consumption in kWh/year*	12 kWh / year	15 kWh / year	17 kWh / year	21 kWh / year
Power consumption standby / off mode	< 0,5 W	< 0,5 W	< 0,5 W	< 0,5 W
Resolution (pixels)	HD READY 1366 x 768	Full HD 1920 x 1080	Full HD 1920 x 1080	Full HD 1920 x 1080
Viewing angle H/V	176° / 176°	176° / 176°	176° / 176°	176° / 176°
Tuner	DVB-S2, DVB-T2 HD/H.265	DVB-S2, DVB-T2 HD/H.265	DVB-S2, DVB-T2 HD/H.265	DVB-S2, DVB-T2 HD/H.265
WIFI	2.4 GHz + 5 GHz	2.4 GHz + 5 GHz	2.4 GHz + 5 GHz	2.4 GHz + 5 GHz
Loudspeaker Music output	2 x 2 W	2 x 2 W	2 x 2 W	2 x 2 W
Dimensions (W x H x D)	43,0 x 25,3 x 4,5 cm	48,8 x 29,4 x 4,9 cm	54,0 x 32,3 x 4,6 cm	61,9 x 37,0 x 4,9 cm
Weight	2,08 kg	2,4 kg	2,8 kg	4,2 kg
VESA standard	100 x 100 mm	100 x 100 mm	100 x 100 mm	100 x 100 mm
Operating voltage (w/mains adapter)**	12 V DC/24 V DC/230 V AC <sup>1</sup>	12 V DC/24 V DC/230 V AC <sup>1</sup>	12 V DC/24 V DC/230 V AC <sup>1</sup>	12 V DC/24 V DC/230 V AC <sup>1</sup>
1xHDMI/1xHDMI ARC/2 x USB 2.0	a/a/a	a/a/a	a/a/a	☑ / a/a
Audio / Video in	3.5 mm AV jack socket AV in			
Headphones	3.5 mm stereo jack socket			
Digital audio output	visual	visual	visual	visual
Power switch On/Off	✓	✓	✓	✓
CI/CI+ module slot	✓	✓	✓	✓
Item no.	49065	49066	49067	49068
Price	539,-	599,-	649,-	749,-

## Oyster® Soundbar



- Elegant design combined with strong and clear sound
- Connections: HDMI ARC, COAXIAL, AUX
- USB interface for direct music playback
- 3 sound effects selectable (EQ): News, Normal, Music
- Compatible with most televisions

## Oyster® soundbar

Impressive sound, versatile connection options and elegant design. The Oyster® Soundbar has a 4-speaker system and is the **ideal complement to our "Oyster® Smart TV"** and is also compatible with other televisions. Installation is simple and the connection is made via HDMI ARC, COAXIAL or AUX. It is also possible to play music directly from a cell phone or tablet via USB or Bluetooth.

**Features:** Power: 2 x 10 W sine wave, energy consumption: 12 V 0.75 A / 24 V 0.42 A, operating voltage: 12 V, 24 V, 240 V (only w/ mains adapter), Dims.: 436 x 46 x 68 mm (W x H x D), Weight: 1.2 kg.

**Scope of delivery:** Soundbar, remote control, mounting bracket for direct mounting on "Oyster® TV", AUX cable, COAXIAL cable, HDMI ARC cable, 110 V - 240 V AC mains adapter w/ EURO Schuko plug, 12 V / 24 V power connection cable.

49029

185,-





Zahlreiche Auszeichnungen krönen die Qualität unserer Megasat-Produkte

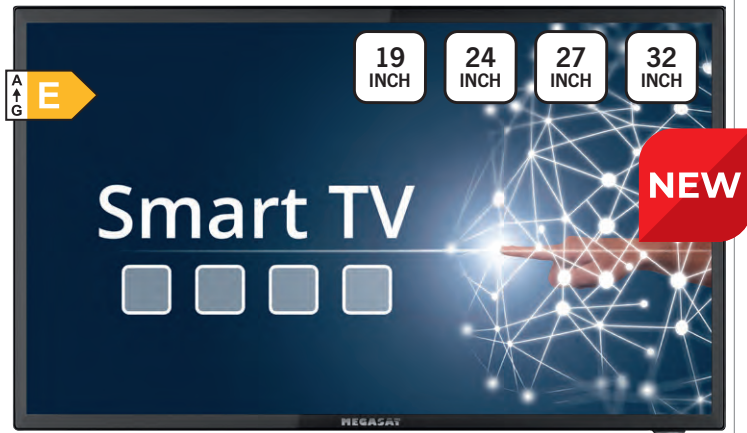
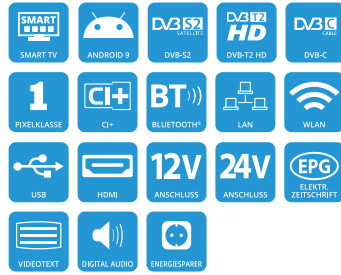

## Royal Line IV Smart TV

- LED display (pixel class 1)
- 1920 x 1080 pixel resolution (Full HD)
- 3000 : 1 contrast ratio / 250 cd/m<sup>2</sup> Brightness value
- Viewing angle: 178° (horizontal) / 178° (vertical)
- Tuner: DVB-S / -S2 / -C / -T / -T2 (H.265/HEVC)
- Program channels: 3,500 (DVB-S) / 700 (DVB-T + DVB-C)
- CI+ slot (HD+ ready)
- Bluetooth® 4.2 interface
- WLAN and LAN interface
- Access to media libraries / video portals and pre-installed apps
- Android 11.0 operating system
- ARM Cortex -A55 processor (1 GB DDR / 8 GB Flash)
- Supported formats: JPEG, BMP, PNG, MP3, AAC, AMR, MPG, AVI, TS, MOV, MKV, DAT, MP4, VOB
- Mechanical power switch
- 2x 5 watt stereo speakers
- 100 x 100 mm VESA standard

The Royal Line IV Smart series with integrated Android 11 operating system offers LAN and WLAN interface. As this is a smart TV, it has an internet browser and pre-installed apps as well as access to many media portals. In addition, numerous other apps can be installed via the integrated app store.

The TV experience is rounded off with a first-class HD quality display that leaves nothing to be desired.

The triple tuner also ensures digital TV reception in other European countries.

Other features include CI+ slot for decrypting pay TV channels and the USB port for media playback of films, images and music.

With integrated Bluetooth® interface, you can wirelessly transmit audio playback to Bluetooth® -enabled headphones or a soundbar.

The devices are specially designed for use in vehicles. A special interior design protects the components from vibrations while driving. Whether boat, caravan or truck, with our camping TV you are well equipped.

You can find the Royal Line Premium Smart TVs at [www.reimo.com](http://www.reimo.com)



Stand can be ordered optionally

TV sets	19 inch	22 inch	24 inch	32 inch
EU energy efficiency	E	E	E	E
Screen size	19" / 47 cm	22" / 55 cm	24" / 60 cm	32" / 81 cm
Annual energy consumption in kWh/year*	12 kWh / year	14 kWh / year	17 kWh / year	25 kWh / year
Power consumption standby / off mode	< 0,5 W	< 0,5 W	< 0,5 W	< 0,5 W
Resolution (pixels)	1366 x 768	Full HD 1920 x 1080	Full HD 1920 x 1080	Full HD 1920 x 1080
Viewing angle H/V	178°/178°	178°/178°	178°/178°	178°/178°
Tuner	DVB-S/S-2, DVB-T/T-2, DVB-C	DVB-S/S-2, DVB-T/T-2, DVB-C	DVB-S/S-2, DVB-T/T-2, DVB-C	DVB-S/S-2, DVB-T/T-2, DVB-C
WIFI	2.4 GHz	2.4 GHz	2.4 GHz	2.4 GHz
Loudspeaker Music output	2 x 5 W	2 x 5 W	2 x 5 W	2 x 5 W
Dimensions (W x H x D)	43,6 x 25,9 x 4,9 cm	50,2 x 30,5 x 4,9 cm	55,2 x 33,2 x 4,9 cm	73,1 x 44,1 x 8,4 cm
Weight	1,8 kg	2,3 kg	2,7 kg	3,5 kg
VESA standard	100 x 100 mm	100 x 100 mm	100 x 100 mm	100 x 100 mm
Operating voltage	12 V DC/24 V DC/230 V AC	12 V DC/24 V DC/230 V AC	12 V DC/24 V DC/230 V AC	12 V DC/24 V DC/230 V AC
3xHDMI/2 x USB 2.0	a/a/a	a/a/a	a/a/a	☞ ) / a/a
Audio / Video in	3.5 mm AV jack socket AV in			
Headphones	3.5 mm stereo jack socket	3.5 mm stereo jack socket	3.5 mm stereo jack socket	3.5 mm stereo jack socket
Digital audio output	Cinch	Cinch	Cinch	Cinch
Power switch On/Off	✓	✓	✓	✓
CI/CI+ module slot	✓	✓	✓	✓
Item no.	49795	497000	49847	49875
Price	369,-	399,-	429,-	499,-

## Soundbar 1 –

### The perfect sound extension for your camping TV

The soundbar is supplied with power via the TV's USB port and audio signals are then transmitted via the headphone socket. It is attached to the underside of the TV using the bracket supplied. The broadband stereo speakers w/ a maximum output of 48 watts provide a pleasant sound & replace standard speakers integrated in TV. Simple and compact design of the soundbar fits in anywhere and is perfect for all camping televisions. Dims.: W 400 mm, H 60 mm, D 55 mm, weight 410 g.

498170 49,90



- 2 full range speakers
- Max. 48 watts (2 x 24 watt integr. amplifier)
- Volume control w/ rotary knob (incl. on/off switch)
- Power supply: 5 volts (via USB)
- LED display for operation



## Avtex Full HD Smart TV with WebOS



Side view (490008, 490009)

- 12 V Smart TV w/ LG WebOS operating system
- Complete European platform with country-specific content providers
- Renowned content providers, incl. Netflix, Prime, Disney+, Sky Store, Alexa, YouTube, Joyn, etc...
- High-quality, elegant design in matt brushed black
- Access to LG App Store & software updates
- Full HD Smart TV w/ integrated HD satellite decoder
- Built-in FreeSat satellite decoder w/ 7-day EPG
- Ultra-compact design from edge to edge
- Integrated Wi-Fi 2.4 & 5Ghz & Bluetooth connectivity
- Wireless transmission from your mobile devices (Android and iOS)
- Timer recording from the program guide (EPG)
- Pause/playback of live TV/fast recording to external HDD
- Voice control (optional with Magic Remote)
- 230V AC / 12V / 24V
- Scope of delivery: Avtex Smart TV, 12V plug, remote control (incl. 2 batteries)



Side view (490005, 490006, 490007)

The new Avtex Smart TVs are packed with new functions and content. Connect your TV to the Internet and discover a whole new world of entertainment with premium streaming services such as Netflix, Amazon Prime, Now TV, Sky Store, Disney+, YouTube, BBC iPlayer and much more!

12~30 VOLT	100~230 VOLT	DVB-T2 DVB-S2	HDMI	WIFI	Bluetooth
USB 2.0	CI+ SLOT	MPEG4	VIDEO TEXT	HEVC 10 bit	LG App Store

### Optional accessory for Avtex Full HD Smart TV:

230 V cable	490010	32,-
TV stand for 19.5"-24"	490011	30,-
TV stand for 27"-32"	490012	40,-

Smart TV	Avtex® TV 19,5"	Avtex® TV 21,5"	Avtex® TV 24"	Avtex® TV 27"	Avtex® TV 32"
Type	W195TS	W215TS	W249TS	W279TS	W320TS
Energy efficiency	F	F	F	F	F
Screen size	19.5"/50 cm	21.5"/55 cm	24"/61 cm	27"/68.5 cm	32"/80 cm
Resolution (pixels)	Full HD 1920 x 1080	Full HD 1920 x 1080	Full HD 1920 x 1080	Full HD 1920 x 1080	Full HD 1920 x 1080
Viewing angle H/V/response time	178°/178	178°/178	178°/178	178°/178	178°/178
Tuner	DVB-T & DVB-T2, DVB-S & DVB-S2 digital HD				
Loudspeaker Music output	2 x 5 W	2 x 5 W	2 x 5 W	2 x 5 W	2 x 5 W
Dimensions (W x H x D)	44,8 x 25,7 x 4,6 cm	49,1 x 28,8 x 4,6 cm	53,9 x 31,7 x 4,7 cm	62 x 36,4 x 4,7 cm	72,1 x 42,2 x 4,2 cm
Weight (with base, not included)	2,7 kg	2,9 kg	3,2 kg	4,5 kg	5,8 kg
VESA standard	100 x 100 mm	100 x 100 mm	100 x 100 mm	100 x 100 mm	100 x 100 mm
Operating voltage <sup>(1)</sup> with mains adapter)	12 V DC/24 V DC/230 V AC <sup>1</sup>				
2xHDMI/2 x USB	a/a	a/a	a/a	a/a	a/a
Audio / Video in	3.5 mm AV jack socket/adaptor to RCA / Cinch**				
Headphones	3.5 mm stereo jack socket				
Digital audio out	optical TOS				
Power switch On/Off	✓	✓	✓	✓	✓
CI/CI+ module slot	✓	✓	✓	✓	✓
Item no.	490005	490006	490007	490008	490009
Price	499,-	549,-	599,-	679,-	749,-



# Avtex Full HD Smart TV with VIDAA

- Integrated DVD player
- Smart TV with integrated HD satellite decoder
- Full HD LED display resolution 1920 x 1080
- DVB-T & DVB-T2 digital tuner
- DVB-S & DVB-S2 Digital HD satellite tuner
- Integrated Wi-Fi 2.4 & 5Ghz
- Freeview Play with reverse EPG
- Streaming via Netflix, Disney+ etc. possible
- Bluetooth connectivity
- Ethernet connection
- Instant recording to USB
- Timer recording from the program guide (EPG)
- W/ 3 HDMI connections & 1 HDMI ARC connection
- Optical audio output
- 2 USB ports
- Wall mounting VESA 100mm x 100mm
- On/off switch
- 12V / 24V / 230V operation
- Ultra-compact frameless design
- Scope of delivery: Avtex Smart TV, 12V plug, remote control (incl. 2 batteries)



The new Avtex SmartTVs have all the advantages of a fully-fledged smart TV and also have an integrated DVD player. The slimmest Avtex TVs to date offer you frameless television. With an internet connection, you get access to a whole new world of entertainment through premium streaming services such as Netflix, Amazon Prime, Disney+, YouTube, etc. Wirelessly transfer photos, videos & music from your mobile directly to your TV. Watch Full HD via your normal antenna or satellite dish, without additional equipment.



12~30 VOLT	100~230 VOLT	DVB-T2 DVB-S2	HDMI	WIFI	Bluetooth
USB 2.0	CI+ SLOT	MPEG4	VIDEO TEXT	HEVC 10 bit	DVD player

### Optional accessory for Avtex Full HD Smart TV:

230 V cable	490010	32,-
TV stand 21.5" and 23.8"	490011	30,-

Smart TV	Avtex® TV 21,5"	Avtex® TV 23,8"
Type	V219DS	V249DS
Energy efficiency	F	F
Screen size	21.5" / 55 cm	23.8" / 60 cm
Resolution (pixels)	Full HD 1920 x 1080	Full HD 1920 x 1080
Viewing angle H/V/response time	178°/178	178°/178
Tuner	DVB-T & DVB-T2, DVB-S & DVB-S2 digital HD	
Loudspeaker Music output	2 x 5 W	2 x 5 W
Dimensions (W x H x D)	48,9 x 29 x 4,4 cm	54 x 31,7 x 4,4 cm
Weight (without foot)	2,4 kg	2,9 kg
VESA standard	100 x 100 mm	100 x 100 mm
Operating voltage(*withmains adapter)	12 V DC/24 V DC/230 V AC <sup>1</sup>	
3xHDMI/2 x USB	a/a	a/a
Audio / Video in	3.5 mm AV jack socket/adapter to RCA / Cinch**	
Headphones	3.5 mm stereo jack socket	
Digital audio out	optical TOS	
Power switch On/Off	✓	✓
CI/CI+ module slot	✓	✓
<b>Item no.</b>	<b>490013</b>	<b>490014</b>
<b>Price</b>	<b>599,-</b>	<b>629,-</b>

**NEW**



**Model series SLA line DWS Smart TVs for internet and streaming**

- Excellent quality: Winner of the Plus X Award for innovation, high quality, design and ease of use
- Integrated soundbar
- Integrated DVD player
- Support for Apple AirPlay 2 and HomeKit
- Next generation WebOS Hub
- Triple tuner (DVB-S/S2, DVB-T/T2, DVB-C)
- CI+ slot and HbbTV
- Flexible recording functions
- Wide-angle displays of highest quality class
- WIFI 2.4 GHz / 5 GHz and Bluetooth® version 5.0
- Including DVB-T antenna (AN5)
- Robust and durable

DVB-T2 DVB-C2 DVB-S2	DVD PLAYER	CD PLAYER	HDMI	2x USB 2.0	CI+ SLOT
HDTV	MPEG4	Headphones	BLUE- TOOTH VERSION 5.0	FULL HD	12V 230V

The new SLA line DWS series from Alpatronics offers first-class entertainment for internet and streaming. Winner of Plus X Award for innovation, high quality, design and ease of use, this series impresses with its quality and state-of-the-art technology. It has an integrated soundbar, a DVD player and support for Apple AirPlay 2 and HomeKit. The latest generation WebOS Hub, triple tuner (DVB-S/S2, DVB-T/T2, DVB-C), CI+ slot and HbbTV enable a wide range of possible uses. The smart TVs are equipped with WIFI (2.4/5 GHz) and Bluetooth® 5.0. The scope of delivery also includes a remote control and the AN5 DVB rod antenna.



**DVB-T rod antenna AN 5 (as replacement or accessory)**

Active DVB-T/T2 antenna for indoor use. Power supply (5 V) directly via the DVB-T receiver/TV or via 12 V DC. Delivery includes connection cable. Dimensions: 162x70 mm, weight: 143 g.

49750 27,-

Devices type	22 inch - SLA line DWS	24 inch - SLA-Line DWS	27 inch - SLA line DWS
Screen format		16:9 LED	
Screen size (inch)	22	24	27
Dims. without base (WxHxD)	492 x 347 x 52 mm	538 x 349 x 52 mm	602 x 390 x 48 mm
Weight (without foot)	3,6 kg	4,3 kg	5,6 kg
Resolution (pixels)	1920 x 1080 Full HD	1920 x 1080 Full HD	1920 x 1080 Full HD
Reception	DVB-T/T2, DVB-C2, DVB-S/S2	DVB-T/T2, DVB-C2, DVB-S/S2	DVB-T/T2, DVB-C2, DVB-S/S2
Contrast	1000:1	1000:1	1000:1
Brightness (cd/m²)	350	300	250
Viewing angle	178 H, 178 V	178 H, 178 V	178 H, 178 V
Inputs/outputs	Antenna, SAT, 2 x HDMI, HDMI ARC, 2 x USB, SPDIF, headphones, AV in, LAN		
Media playback	CD, DVD, VCD, MP3, DVD-R, DVD-RW, DivX, JPEG		
Energy efficiency	E		
Annual Energy consumption (1000 h)	15 kWh / year	18 kWh / year	21 kWh / year
Further features	12/230 volt, 16.7 million displ. colors, PAL/SECAM, teletext, 5 pict. modes/5 sound modes, 2 x 5 W, sleep timer, dual band WiFi (2.4 GHz / 5 GHz), VESA standard, FULL.		
Item no. / Price	497023 579,-	497024 659,-	497025 699,-

We reserve the right to make technical improvements or changes and to supply a product of comparable quality from another manufacturer or supplier. The images are similar to delivered products. Dimensions without guarantee. Technical data for all individual variants at www.alphatronics.de



### Wall Mount - TV wall mount

- Knurled screws for quickly fixing the correct TV position
- With locking mechanism for safe transportation
- 2 joints, swivel & tiltable
- For screens from 13 to 30 Inch
- Load capacity up to max.15 kg
- Perforated rim 75 and 100 mm (VESA)
- Material: Aluminum

#### ① TV Holder Simon Luxury

Secure locking while driving. Arm length 175 mm each. Length folded out 430 mm. Weight: app. 1 kg.

<b>Silver</b>	<b>493960</b>	<b>69,95</b>
<b>Black glossy</b>	<b>493983</b>	<b>69,95</b>

#### ② TV holder Simon Luxus XL

Secure locking while driving. Arm length 285 mm each. Length unfolded 650 mm. Weight: approx. 1.4 kg.

<b>Silver</b>	<b>493970</b>	<b>79,95</b>
<b>Black glossy</b>	<b>493984</b>	<b>79,95</b>

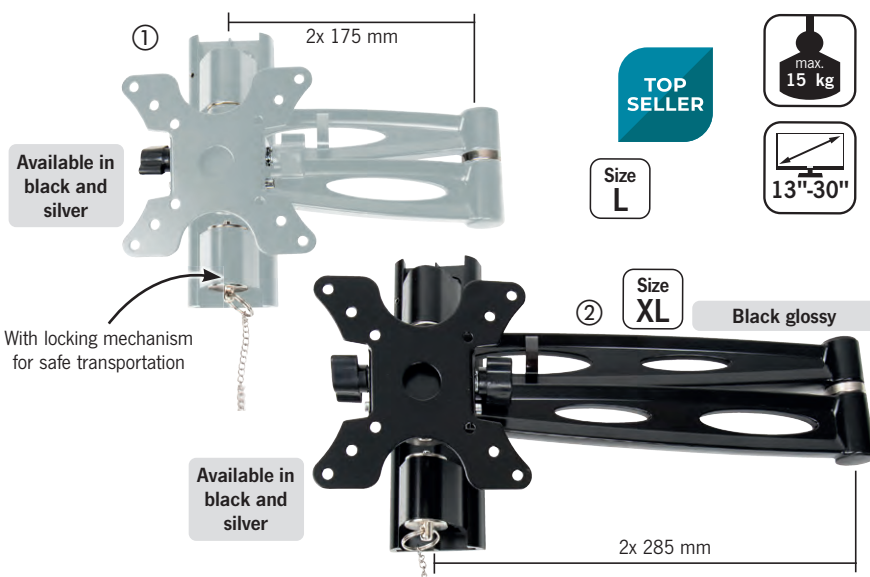

### Wall Mount - TV wall mount

- Knurled screws for quickly fixing the correct TV position
- For screens from 13 to 30 Inch
- Perforated rim 75 and 100 mm (VESA)
- Load capacity up to max.15 kg
- Material: Aluminum

#### ① Wall Mount TV Holder S

Dims.: 114 x 114 x 98 mm Weight: 0.6 kg.

<b>Silver</b>	<b>493962</b>	<b>29,95</b>
<b>Black matte</b>	<b>493980</b>	<b>29,95</b>

#### ② Wall Mount TV Holder M

Dims.: 116 x 152 x 81 - 235 mm Weight: 0.8 kg.

<b>Silver</b>	<b>493961</b>	<b>47,95</b>
<b>matt black</b>	<b>493981</b>	<b>47,95</b>

#### ③ Wall Mount TV Holder L

Dims.: 116 x 152 x 81 - 390 mm

Weight: 1 kg.

<b>Silver</b>	<b>49396</b>	<b>49,95</b>
<b>Black matte</b>	<b>493982</b>	<b>49,95</b>

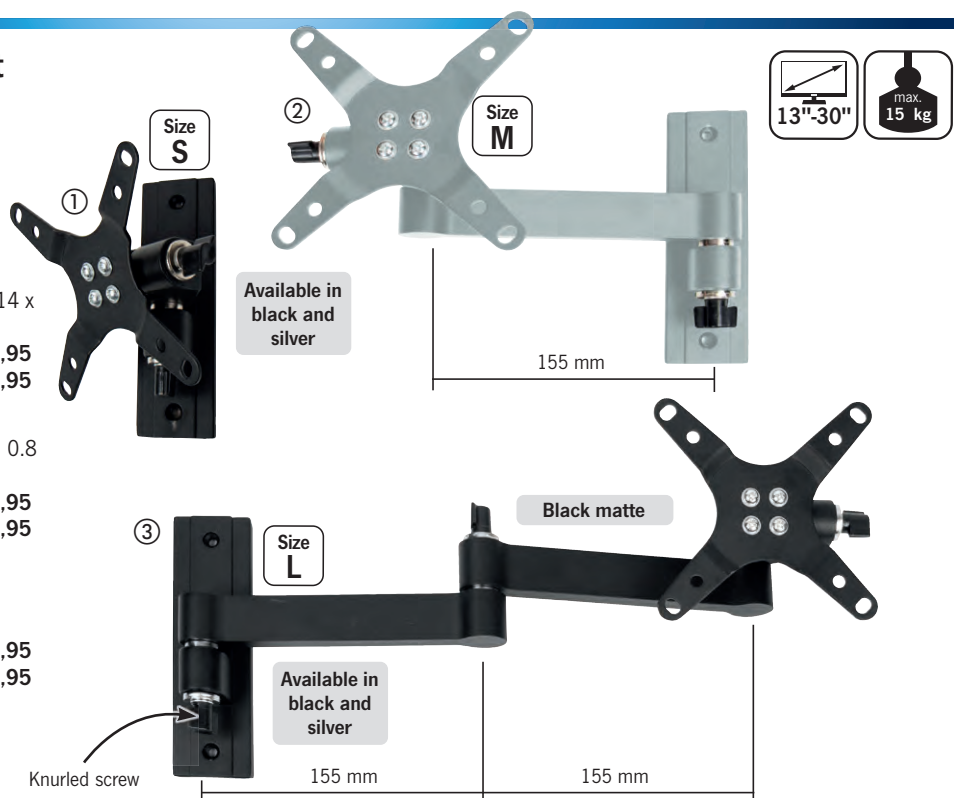

### TV mount "Sky Basic" in black

① **TV wall mount S** – With locking mechanism for safe transportation. 2 joints, swivel & tiltable. Arm length 122 mm. Material: steel, color: black, hole spacing for TV mounting: VESA 75 mm and 100 mm. Load capacity: 7 kg. **496862 74,-**

② **TV wall mount L** – With locking mechanism for safe transportation. 3 joints, swivel & tiltable. Arm length 122 and 210 mm. Material: steel, color: black, hole spacing for TV mounting: VESA 75 (75x75 mm) and VESA 100 (100x100 mm). Load capacity: 7 kg. **496863 89,90**

③ **XL TV wall mount** – With locking mechanism for safe transportation. 3 joints, swivel & tiltable. Arm length 186 and 274 mm. Material: steel, color: black, hole spacing for TV mounting: VESA 75 (75x75 mm) and VESA 100 (100x100 mm). Load capacity: 7 kg. **496864 109,-**



# TV AND MONITOR HOLDER

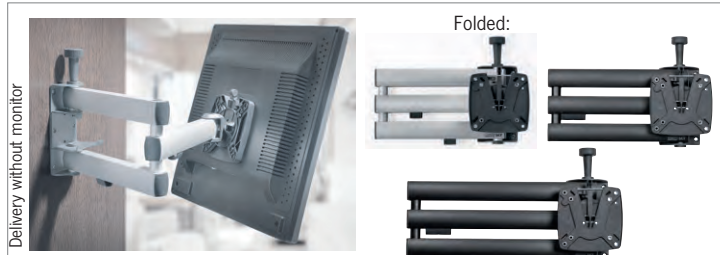

## TV mount with large swivel range

- Wall lock and quick-release plate
- Wall distance folded in 80 mm
- Large tilt angle (e.g. for high-hanging TFTs)
- Very light, with high load capacity (10 kg)
- TV bracket with locking bolt

### SKY 10N TV mount, 2-arm, 480 mm

With double-jointed arm, inst. height 65 mm, arm length 200 mm each, ext. 480 mm, weight 2 kg, load cap. max. 10 kg.

Color: Silver 493940 236,-  
NEW: Color: Black 493957 249,-

### SKY 10N TV bracket, 2-arm, 780 mm

W/ double-jointed arm, installation height 65 mm, arm length 350 mm each, extension 780 mm, weight app. 2.5 kg, load cap. up to 10 kg (not shown).

Color: Silver 493942 249,-  
NEW: Color: Black 493958 269,-

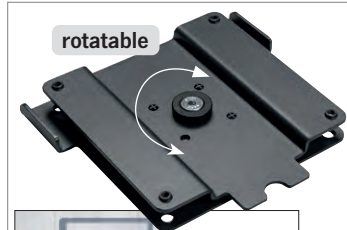

## 90° pivot adapter VESA for Sky mounts

Pivot adapter for all Sky TV mounts, steel, color: anthracite, VESA 100mm, with mounting screw. Allows you to rotate your TV by approx. 90° and lock it vertically.

493956 59,90



## SKY HF wall mount with quick-release

The small swivel and tilt TFT mount. Quick-Out System: TFT can be removed in one easy step. Dims.: 90 x 158 x 72 mm, weight: 900 g, load cap.: 10 kg. Wall distance: 72 mm.

493946 113,-



## Adapter plate Vesa Sky for wall bracket Sky N and HF

Steel, powder-coated. Color: black, for Quick-Release 100 x 100, (for Vesa standard 200 x 100, 200 x 200, 300 x 170), weight 1 kg.

493950 42,-



## ① SKY 15N TV mount

Wall mounting w/ mounting rail. Holder can be rotated, swiveled, tilted & height-adjusted. Incl. 4 cable clips. Arm lengths: 46 cm and 26 cm, weight app. 2.5 kg, load cap. up to 10 kg.

493944 315,-

## ② SKY 15N wall rail

suitable for SKY 1 N. Better distribution of the holding force on weak/thin walls. With concealed screw channel & 2 cover caps.

Rail length 1050 mm. 493948 97,-



## SKY 12N TV mount

Wall bracket with 1 arm, arm length: 200 mm. Double joint, locking mechanism and quick-release plate for quick removal of the TV. Wall distance app. 280 mm. Weight: 1.5 kg. Loadable up to 12 kg.

493991 149,-



## TV mount with large swivel range & locking mechanism

- Extremely flat (34 mm)
- With 3 pivot points
- With locking mechanism
- Very wide swivel range



Wall distance when folded out: 500 mm, dims.: W 296 x H 125 x D 34 mm, height with lever 250 mm, black powder-coated steel, load cap. up to 6.5 kg. With locking mechanism for safe transportation.

493971 99,-



## Laterally extendable and swiveling TV mount HUB800

- Manually extendable
- Pivotal
- Wall mounting
- Load cap. max. 5 kg

Dims. retracted (LxWxH): 317 x 72 x 171 mm.  
Dims. extended (LxWxH): 695 x 72 x 171 mm Weight 3.2 kg,  
Material: Steel, plastic, color: grey

493988 169,-





**Caratec Flex TV mount with 3 pivot points**

- With locking mechanism
- Loadable up to 6.5 kg

Compact holder with locking mechanism. Wall distance app. 370 mm when folded out. Load capacity: 6.5 kg. Weight: 1.4 kg. Dims.: app. B235 x H250 x D34 mm. Material: powder-coated steel

**493985 89,-**



**Caratec Flex front pull-out**

- Rotatable and swiveling
- With automatic locking
- Loadable up to 6.5 kg

Automatically locking pull-out for TV cabinets, can be mounted horizontally or suspended, rotates & swivels. Allows the TV set to be pulled out by max. 470 mm, the rail length when extended is approx. 792 mm. Load capacity: 6.5 kg. Weight: 2.5 kg.

Dims.: app. B180 x H85 x D370 mm. Material: Aluminum

**493986 209,-**



**TOP SELLER**

**Caratec Flex lateral pull-out**

- With automatic locking
- Loadable up to 6.5 kg

Classic TV pull-out with automatic locking, can be mounted on the left or right. Allows TV set to be pulled out by max. 470 mm, the rail length when extended is approx. 835 mm. Inclination of retaining plate: +/- 8 degrees. Load capacity: 6.5 kg. Weight: 2.6 kg. Dims.: app. W410 x H155 x D42 mm. Material: Aluminum

**493987 199,-**

**TV linear drawer SKY 20W & SKY 20W Light for wall mounting with shallow installation depth**

- TV can be rotated up to 180° when extended
- With locking while driving

TFT wall mount SKY 20W (VESA 75+100). Pull-out with locking lever to secure the screen while driving. Cable routing included. Depending on installation situation, screen can optionally be rotated by 90° to achieve a shallower installation depth. Screen can be swiveled up to 180° when extended. Tilt adjustment +/- 10°. Silver anodized. Profile length: 330 mm, load cap.: max. 6.5 kg. Dims. unassembled: 390 x 115 x 57 mm (L x H x D). Material: Aluminum profile.

**SKY 20W**, Weight: 3.25 kg **49688 275,-**  
**NEW: Sky 20W Light**, weight: 1.9 kg **49872 275,-**

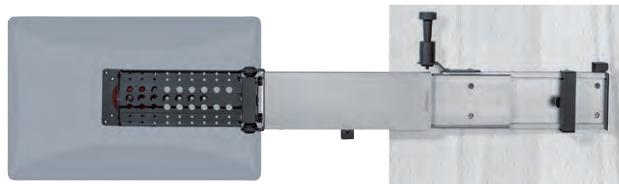

**NEW**



**TV linear drawer SKY20C for cabinet base**

- For horizontal mounting on floor
- Wide range of alignment options
- Silver anodized

Pull-out with locking lever to secure the screen while driving. Profile length: 330 mm, material: aluminum profile. Incl. Cable routing.

**493951 369,-**

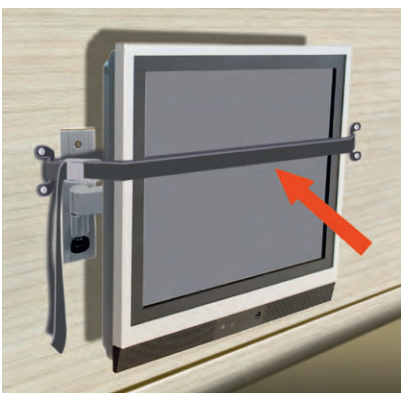
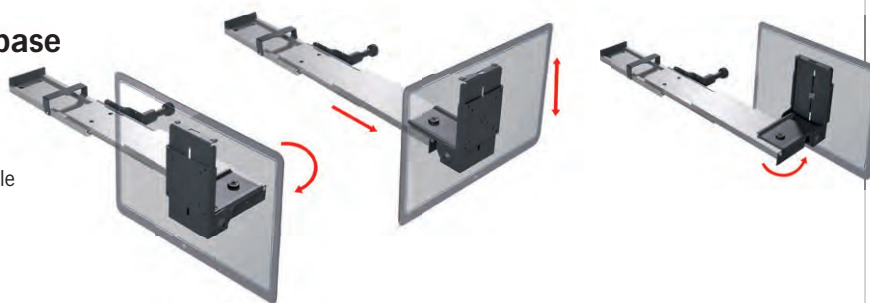

**i** Always secure your TV w/ a lashing strap before setting off!

**Tensioning straps**

W/ rubberized inner surface. Available in 2 lengths. (Please also order retaining bracket)

- ① Belt length 110 cm. 1 pc. **74009 5,20**
- ② Belt length 200 cm. 2 pcs. **44200 11,95**
- ③ Retaining bracket for tension belts  
Material: metal, color: black, 2 pcs. **29471 9,30**



**TV bracket for wall mounting**

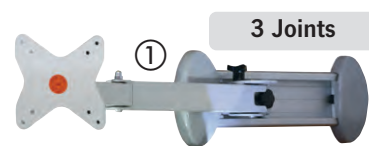

3 Joints

**① TV wall mount swivel and extendable**

- Variable due to 3 joints
- Can be moved on rails
- Swivels out to 99 cm max. load cap. up to 8 kg. Weight. 1.95 kg. Silver-colored, rail length 50 cm

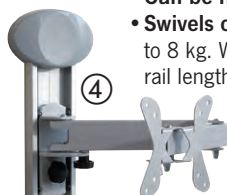

**④ TV wall bracket, height-adjustable**

- With height adjustment
- Guide rail 99 cm Arm length: 427 mm. Max. load cap. up to 8 kg. Weight 1.9 kg. Silver-colored.

43399 164,-

49673 147,-



3 Joints

**② TV wall mount, tilt-adjustable**

- Variable due to 3 joints
- Swivel radius up to 54 cm
- Blocking while driving. Loadable up to 8 kg. Silver-colored. W 314/496 x H 179 x D 85 mm. Weight 1.3 kg. 49385 130,-
- W 386/648 x H 179 x D 85 mm. Weight 1.5 kg. 49672 142,-



**⑤ Monitor holder, height-adjustable**

- extendable with alignment
- Slide rail length 900 mm, loadable up to 8 kg, weight 1.55 kg, max. extension 231 mm + 20 mm, depth of rail. Silver-colored. 49737 130,-

**③ Monitor holder, height-adjustable**

with alignment, slide rail length 900 mm, loadable up to 8 kg, weight 1.65 kg, max. ext. 421 mm + 20 mm depth of the rail, adjustable up to 23° Silver-colored. 49738 142,-

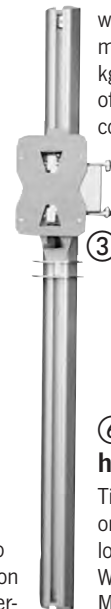

**⑥ Monitor holder, height-adjustable**

Tilt option, can be mounted on left and right, loadable up to 8 kg, Weight 1.86 kg, Max. extension 443 mm. Silver-colored. 433990 119,-

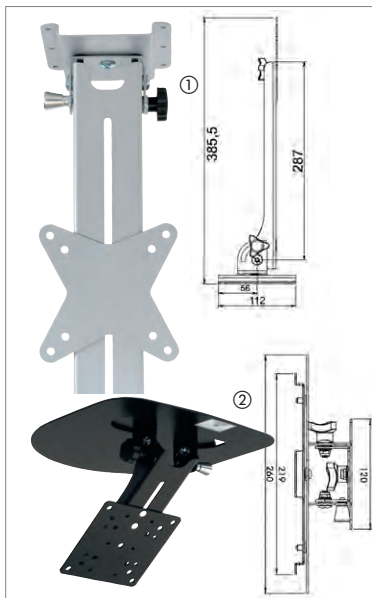
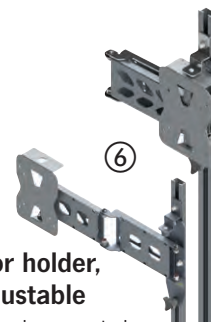

**TV bracket for ceiling mounting**

**① TV ceiling bracket w/ height adjustment**

- Swivel & foldable
- Rail: 343 mm. Loadable up to 10 kg. Automatic lock. Closed: 343 x 114 x 58 mm. Weight 2.0 kg. Silver-colored.

494521 82,-

**② TV ceiling bracket can be tilted & aligned.**

- Swivel & foldable
- Loadable up to 7 kg. Automatic lock. Closed: 275 x 260 x 60 mm. Weight 2.0 kg. Black.

49452 106,50

**TV wall and cabinet bracket**

- Console can be rotated and tilted
- Loadable up to 10 kg

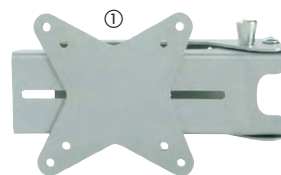

**TV wall bracket**

Max. loadable up to 10 kg. Closed dims.: L 210 x W 120 x H 47 mm. Weight 0.82 kg. Silver-colored.

49687 68,95

**TV holder for cabinet mounting**

For 8-24" Monitors. W 260 x D 365 mm, extended 826 mm. Height adjustable. Swivels, can be tilted forwards. Space-saving, as it can be folded down 90°. Weight 3.8 kg.

49386 119,-

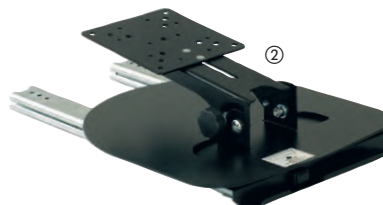

**Mobile TV holder w/ quick-change system**

- Innovative quick-change system
- With 12 volt socket
- With built-in antenna socket

**Removable TV holder w/ 12 V & TV aerial socket**

Extendable up to 227 mm. Safety lock (locking while driving). Headboard can be rotated & tilted up to 10°. Support device (remains attached to TFT) is removed from wall plate (remains on wall) using a detachable locking mechanism. The TV can thus be moved outdoors or hung with an additional wall plate (optional). Base is equipped with 12 V and TV socket. Load capacity up to 8 kg, weight: 1.9 kg. TFT holder complete, black.

496801 99,95

Additional wall plate (with 12 V & antenna socket)

496802 49,95

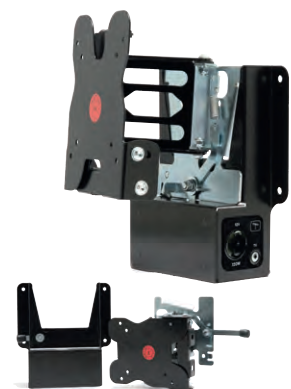

Delivery without monitor



**TV holder, vertically extendable**

- Extendable from top to bottom, extension 385 mm
- When extended, can also be rotated by 18° to right / left
- Blocking in extended position

Closed dims.: 195 x 310 x 65 mm, extension 385 mm, weight 2.9 kg, silver color. 49680 158,-





**LIPPERT**

**TV holder for cabinet installation**

- Extendable to the side
- Very flat design
- Extendable with automatic locking in closed form
- Rail length 465 mm. Extension length 1017 mm
- When extended, monitor can be rotated up to 220°
- Load capacity up to 10 kg, weight 4.6 kg

Lateral pull-out to the right	493967	158,-
Lateral pull-out to the left	493968	154,-
Delivery without monitor		

**TOP SELLER**



**LIPPERT**

**Manual TFT drawer, vertical**

- Vertical extension from top to bottom
- Blocking in extended position
- Screen is 360° tiltable
- Silver colored

Dims.: 415 x 860 x 76 mm, weight 3.1 kg  
496782 168,-



**LIPPERT**

**Convert from "tube to TFT" now**

- Conversion from tube device console to TFT attachment
- With brakes
- Loadable up to 8 kg

**TV conversion attachment for swivel console**  
(for CRT sets) Convert your existing CRT set swivel console for TFT televisions. Remove mounting plate and attach conversion kit. Max. load capacity up to 8 kg. Button blocking.  
Closed dims. 275 x 260 x 60 mm. Weight of the attachment 1.55 kg.

	49676	71,80
--	-------	-------

(swivel bracket not incl. in scope of delivery)



Suction cup holder with quick release For quick removal of the TV. Suction cup diameter 112 mm, weight 700 g, wall distance: 6 cm, load cap.: 10 kg.

	493912	169,-
--	--------	-------



**LIPPERT**

**TV wall bracket**

73,95

- Tilttable and swiveling
- Loadable up to 10 kg

Compact and robust TV mount with knurled screws for adjusting the tilt angle. The wall bracket can be tilted up and down. Swivels to the left and right. Weight 0.80 kg. Color: Silver grey

	49670	73,95
--	-------	-------

**Extremely stable and high-quality brackets**

- Simple locking with just one hand movement
- A wide range of mounting options
- Base with quick release

All 3 components are required for mounting



**SCANSTRUT**

Adjustable support arm  
493460 55,95



Holding system with suction cup  
493465 36,95



Tablet holder  
493466 39,95

You can find more universal brackets in Living comfort on page 534



**CARBEST**

**Universal tablet/mob. phone holder**

Perfect for mounting on headrest in vehicle or on bicycle handlebars. Suitable for smartphones and tablets. For appliance widths of app. 10 - 17.7 cm. 360° rotatable.

	462381	22,95
--	--------	-------

Decoration not incl. in scope of delivery.



## Active DVB-T2 omnidirectional antenna

- Intended for mounting on the vehicle roof
- Integrated amplifier
- Concealed cable routing (through antenna base)

Antenna with the latest SMD technology. Excellent reception of digital terrestrial TV (DVB-T) and radio programs (DAB radio). Reception of local/regional FM radio signals. With built-in amplifier. Extremely wide frequency range. Weatherproof, rust-proof, design w/ aluminum base.

### Technical data:

Frequency ranges: FM 87.5-108 MHz, VHF 174-230 MHz, UHF 470-862 MHz, aperture angle: vertical 90°/horizontal 360°, output level: max. 108 dB V, gain: 32 dB, input voltage: DC12/24 V, operating voltage: 5 V DC, connection: F plug. Dims.: Ø base: 13 cm, Ø antenna: 30 cm, total height: 20 cm

49410

109,90



## Digital terrestrial 360° DVB-T2 antenna Wing 11

The **Wing 11 antenna series** antenna series was developed to receive terrestrial digital signals. Aerodynamic shape for low air resistance. Special base for antenna tilt in any direction. For mounting on roofs of motorhomes, caravans or yachts. Special antenna design enables reception of TV programs even in low frequency range (VHF-B3). With LTE/4G filter against interference.

### Technical data:

Gain: CH 5 - 12: 16 dB, CH 21 - 60: 26 dB, power supply: 12/24 V, diameter: 38 cm, height: 16.5 cm, weight: 1.2 kg.

**Scope of delivery:** 1 antenna w/ 5 m coaxial cable & 3 F connectors, 1 amplifier w/ adjustable gain & 3 outputs for TV + 1 radio output DAB & FM.

491940

262,-



## Active VHF/UHF DVB-T2 antenna for indoor and outdoor use

- For receiving digital terrestrial DVB-T programs
- Reception range VHF: 174 - 230 MHz, UHF: 470 - 862 MHz
- Horizontal and vertical polarization
- Gain B III: 18 dB; UHF: 15 dB

### ① DVB-T2 outdoor antenna BZD 40

Horizontal and vertical polarization. Extremely low noise figure. Connection with F socket and weather protection cap. Remote power supply (5 V/30 mA) via coaxial cable through the connected DVB-T2 receiver or w/ external remote power supply unit (2-25 V). Mounting for wall and floor. 10 m connection cable. F and ICE plug. Instructions. Dims.: 25 x 7.5 cm. Weight: 1.1 kg

49438

121,-

- ### ② DVB-T2 indoor antenna BZD 32
- Active VHF/UHF antenna w/ integrated amplifier for receiving digital terrestrial TV & radio programs (DVB-T/-T2). **Remote power (5 V/30 mA) is supplied via USB remote power cable, e.g. from TV set.** Connection: IEC socket, Integrated blocking filter against GSM & LTE interference. Dims.: 14 x 19.5 cm. Weight: 0.5 kg

49105

72,-





**Traveler-Man 3**

- Fully automatic antenna with Bluetooth function for operation via smartphone
- Satellite selection & firmware updates directly via cell phone
- Free app for iOS and Android devices

**Technical data:** Antenna type: Flat antenna, LNB type: Universal LNB, Number of max. subscribers: 2, Frequency band: Ku band, Input frequency range: 10.7 GHz - 12.75 GHz, Polarization: V/H, Signal gain: 33 dBi @ 12.7 GHz, Minimum EIRP (footprint): 49 dBW, Elevation (tilt): 0° - 90°, Azimuth (rotation): 365°, Auto skew function, 2-axis DC motor, Temp. range: -25°C - +70°C, Power supply: DC 12 Volt, Dims. retracted: L 48 x H 14.5 cm.

**Scope of delivery:** Traveller-Man 3, control unit, roof ducts, 1m coaxial cable, 10m coaxial cable, operating instructions

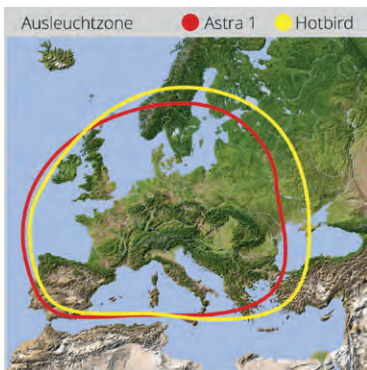

496006

1199,-



**Fully automatic twin LNB system for 2 receivers**

- CAP 650 GPS receiver-independent, incl. converter
- Automatic retraction of the antenna at engine start
- Prepared for CAPcontrol Kathrein app

**Technical data CAP 650:**

OSD menu. Software update via converter. Automatic alignment to other satellites when changing channels. Emergency switch-off in case of overload.

**Supply voltage (car battery): 11.5 - 13.8 V, current consumpt. from 12 V vehicle electrical system: switch-on current 10 - 12 A, satellite search 3 A, for TV reception 1.2 A, in stand-by 24 mA, from receiver 160 mA.**

Installation height (lowered) only 21 cm. Weight of turntable and antenna: 14.5 kg. Total weight: 23.4 kg. Max. permissible driving speed: 130 km/h.

**CAP 650 GPS:** turntable, twin LNB, CAP converter with control unit suitable for any SAT TV set **491985** **1899,-**

**HDP650GPS Dreheinheit:** Twin LNB, no control unit therefore suitable for operation via Kathrein televisions **491990** **1849,-**



Reception area  
BAS 60/BAS 66/  
CAP 620/CAP 650



**Powerful TWIN flat antenna BAS 66 with skew**

- No protruding LNB
- Dirt-repellent coating
- Mobile or stationary use
- With 2 receiver connections

With a side length of 50 cm, it offers almost the same reception performance as a 60 cm dish antenna. Integrated twin LNB, analog & digital compatible. Frequency range from 10.70 - 12.75 GHz. Reception of ASTRA, Eutelsat - Hot Bird satellites. Mounting on pole HDM 140/141/143. Dims. 500 x 500 x 109 mm. Weight 6.9 kg.

492221

279,-



Reception area  
BAS 60/BAS 66/  
CAP 620/CAP 650



With twin LNB



We recommend: Mast 49215 or 49216

# AUTOMATIC FLAT ANTENNA - IDEAL FOR SPACE PROBLEMS

**tenHaaft**  
Innovative Mobile Technology

## CARO+ VISION

### Elegant and extremely flat design

- One-cable technology
- APP operation, automatic updates via APP
- Fully automatic satellite detection & identification at the touch of a button
- Automatic retraction when vehicle is started (terminal 15 must be connected)
- Very small radius of action
- Extremely low inst. height and space requirement (app. 14 cm)
- Weatherproof, wind-resistant construction
- QM-certified manufacturer according to ISO 9001
- Reliable service
- Motor-controlled outdoor unit, complete w/ flat antenna & LNB
- Scope of delivery: mounting material, instructions & connection cable
- Type approval mark 10R - 068566

### Basic variant

Fully automatic satellite system w/o. receiver, especially for customers who only need a satellite system & already have their own receiver or a TV set w/ integrated receiver.

Ø aerial mirror: 74 cm, rotation range: 98 cm. Ø mounting plate: 36 cm. Height/length when folded: 14/79 cm, weight app. 15 kg.

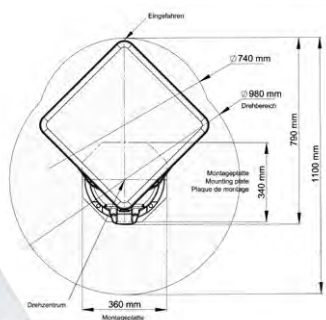

● Astra 1 ● Hotbird

Antenna	Item no.	Price
Caro+ Vision Single	49309	2045,-

## CARO+ PREMIUM

TOP  
SELLER

- Identical equipment to Caro+ Vision
- Benefit from Premium version: Combine Caro+ Premium with an Oyster® TV Smart TV version and enjoy the advantage of operating antenna and TV with just one remote control

### Premium variant

Fully automatic satellite system in premium version, especially for customers who want convenient operation. This premium system allows you to operate the antenna and TV simply and easily with just one remote control.

Antenna	Item no.	Price
Caro+ Premium Base Single	49048	2015,-

### Combine the Caro+ Premium Base Antenna with a TV of your choice:

Oyster® SMART TV	Item no.	Price
19"	49065	539,-
21,5"	49066	599,-
24"	49067	649,-
27"	49068	749,-



Height: app. 14 cm  
Weight: app. 15 kg



Caro+ Premium and Oyster® TV with just ONE Remote control



# Cytrac<sup>DX</sup> VISION

Compact with gigantic reception range

- One-cable technology
- APP operation, automatic updates via APP
- Small, compact antenna for space-saving installation on vehicle roof
- Simple, easy and intuitive to use
- Fully automatic alignment and satellite detection usually in 30 to 60 seconds
- LEM technology: search time reduction (antenna searches at the last set tilt angle)
- Automatic retraction when vehicle is started (terminal 15 must be connected)
- High-quality processing of robust materials
- A solid, safe construction
- Type approval mark 10R - 068566

### Basic variant

Fully automatic satellite system w/o. receiver, especially for customers who only need a satellite system & already have their own receiver or a TV set w/ integrated receiver.

Ø antenna mirror: 68 cm, rotation range: 90 cm. Ø mounting plate: 36 cm. Height/length when folded: 14/77 cm, weight app. 16 kg.

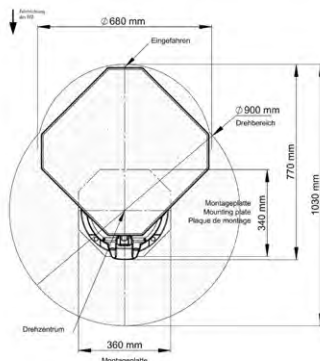

● Astra 1 ● Hotbird



Antenna	Item no.	Price
Cytrac DX Vision Single	49040	2335,-
Cytrac DX Vision Twin	49041	2529,-

# Cytrac<sup>DX</sup> PREMIUM

- Identical equipment to Cytrac DX Vision
- Benefit from Premium variant: Combine the Caro+ Premium with an Oyster<sup>®</sup> TV Smart TV variant and enjoy the advantage of operating antenna and TV with just one remote control

### Premium variant

Fully automatic satellite system in premium version, especially for customers who want convenient operation. This premium system allows you to operate the antenna and TV simply and easily with just one remote control.

Antenna	Item no.	Price
Cytrac DX Premium Base Single	49046	2305,-
Cytrac DX Premium Base Twin	49047	2499,-

Patented Antenna-technology

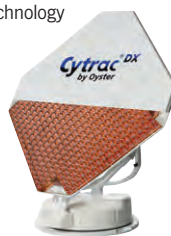

Combine the Cytrac DX Premium antenna with a TV of your choice:

Oyster <sup>®</sup> SMART TV	Item no.	Price
19"	49065	539,-
21,5"	49066	599,-
24"	49067	649,-
27"	49068	749,-



Height: app. 14 cm  
Weight: app. 16 kg



# SAT SYSTEMS FROM HIGHEST QUALITY.

The satellite systems with Bluetooth control from SR Mecatronik are among the most technologically advanced on the market. They impress with their high quality and reliability. The robust mechanism with metal gear elements ensures a long service life and a low failure rate.



## The SR Mecatronik Bluetooth app control offers you many advantages:

- Automatic software update, without technical assistance from customer service - switch the antenna on or off
- Manual control of the antenna if required
- Search and selection from the 19 pre-programmed satellites
- Checking the battery level, signal strength and signal quality
- App available for Android and iOS

Scan QR code and download the free app:

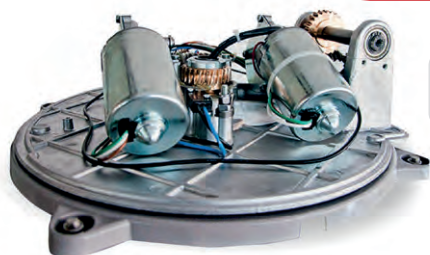

High processing quality and robust metal mechanism.

## Optional accessory for operating antennas without a smartphone or tablet:



**LED control panel 7 pre-programmed satellites:**  
 Hotbird 13E, Astra 19, Thor, Sirius, Atlantic Bird, Hispasat, Astra 28.  
 Scope of delivery: Control panel & connection cable to antenna  
**49724 149,-**



**Comfort "Plus" LCD control panel. 15 pre-programmed satellites & additional functions:**  
 Hotbird 13E, Astra 19E, Astra 28E, Eurobird 16E, Thor 1W, Sirius 5E, Atlatic Bird 5W, Hispasat 30W, Eurobird 9E, Eutelsat 7E, Eutelsat10E, Amos 3W, Atlantic Bird 8W, Atlantic Bird 12W, Astra 23.5E. Scope of delivery: Control panel & connection cable to antenna  
**49725 179,-**



## ASR 680 Bluetooth series

Robust, fast and quiet. With a parabolic diameter of 68 cm, you have excellent reception throughout Europe. Available as single or twin LNB version. Dims. retracted: LxWxH 790x630x215 mm, weight: 15.5 kg. Cable length: 5m. Scope of delivery: satellite system, cabling, installation & operating instructions.

<b>ASR 680 (Single)</b>	<b>49133</b>	<b>1073,-</b>
<b>ASR 680 DF (Twin)</b>	<b>49134</b>	<b>1309,-</b>

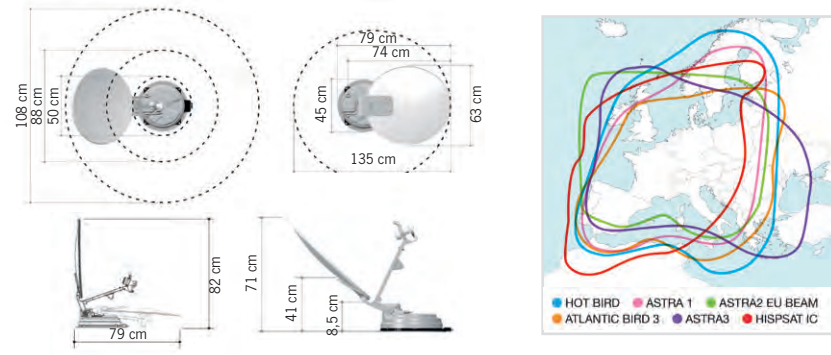

## ASR 800 Bluetooth series

The parabolic mirror with a diameter of 80 cm also makes it possible to watch TV channels that are more difficult to reach. Available as single or twin LNB version, with or without SKEW. Dims. retracted: LxWxH 900x750x190 mm, weight: 15.8 kg. Cable length: 5m. Scope of delivery: satellite system, cabling, installation & operating instructions.

<b>ASR 800 (Single)</b>	<b>49135</b>	<b>1359,-</b>
<b>ASR 800 Skew (Single)</b>	<b>49137</b>	<b>1749,-</b>
<b>ASR 800 DF (Twin)</b>	<b>49136</b>	<b>1449,-</b>
<b>ASR 800 Skew DF (Twin)</b>	<b>49138</b>	<b>2295,-</b>

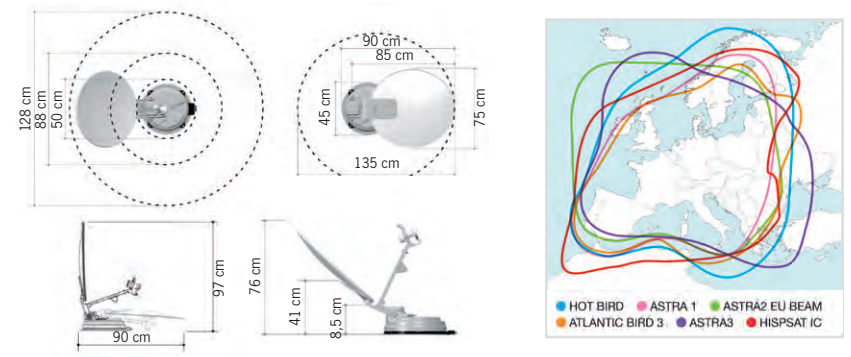

## ASR 900 Bluetooth series

Powerful, extremely flat antenna series with a parabolic diameter of 90 cm. Best TV entertainment also in peripheral regions such as Spain or Portugal. Available as a single or twin LNB version, each w/ skew function. Dims. retracted: LxWxH 1050x850x190 mm, weight: 15.5 kg. Cable length: 5m. Scope of delivery: satellite system, cabling, installation & operating instructions.

<b>ASR 900 Flat Skew (Single)</b>	<b>49145</b>	<b>1749,-</b>
<b>ASR 900 Flat Skew DF (Twin)</b>	<b>49146</b>	<b>1840,-</b>

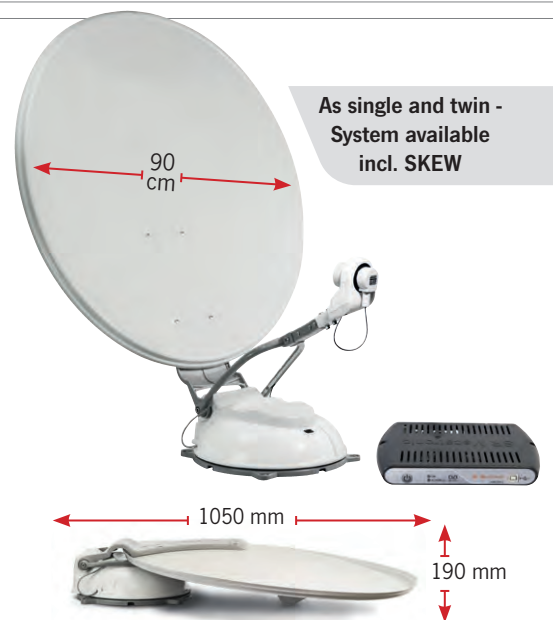
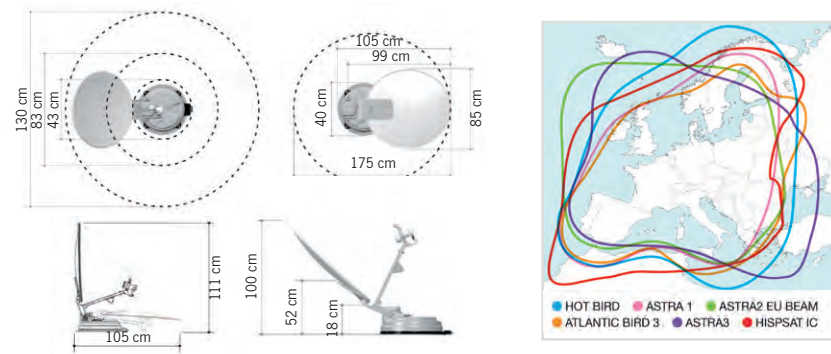



1499,-

## Quality at a top price! Multi-Sat system X85 Twin + Skew

- Automatic folding on engine start
- Extremely robust, maintenance-free metal drive
- Super easy operation, receive on Button to select the desired satellite

Technical data: 10 satellites pre-programmed, input frequency: 10.7 ~ 12.75 GHz, output frequency: 950 ~ 2,150 MHz, polarization: vertical & horizontal, angle range elevation: 0° ~ 145°, angle range azimuth: 390°, power supply: DC 12 Volt, operating temp.: -20° C to +60° C. Scope of delivery: Multi-Sat antenna, controller, roof feed-through, mounting plate, LNB protective film, connection cable, screws, operating instructions.

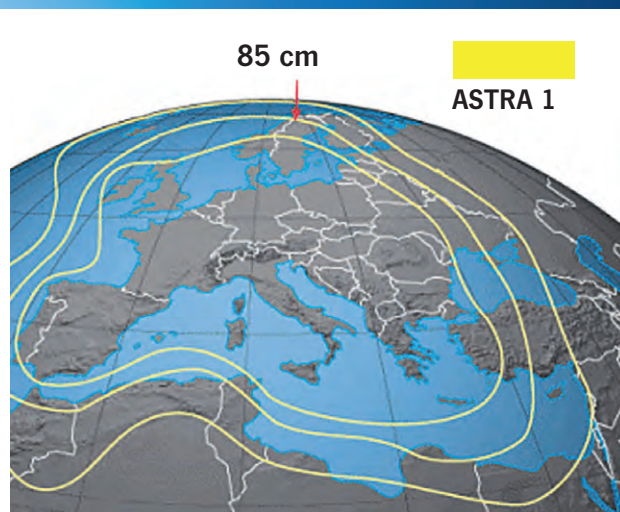

12V	Ø 85 CM	TWIN LNB	AUTO SKEW	GPS RECEIVER
10 SATELLITES PRE-PROGRAMMED	AUTOMATIC RETRACTION AT VEHICLE START	SATELLITE SEARCH RUN: APPROX. 180 SEC.	DiSEqC 1.0/1.1	COLOUR: WHITE

### Satellite Antenna Multi-Sat X85 Twin + Skew 10 satellites pre-programmed

SAT system Multisat 85 cm Twin LNB + AUTO SKEW, pre-installed satellites: **Turksat, Astra 2, Astra 3, Astra 1, Hotbird, Eutelsat 9, Astra 4, Thor, Eutelsat 5W, Hispasat**, compact yet high reception performance, satellite search time max. 180 sec., software update via USB, retracted dims.: 110.5 x 86 x 18.4 cm, weight: app. 14 kg **49633 1499,-**

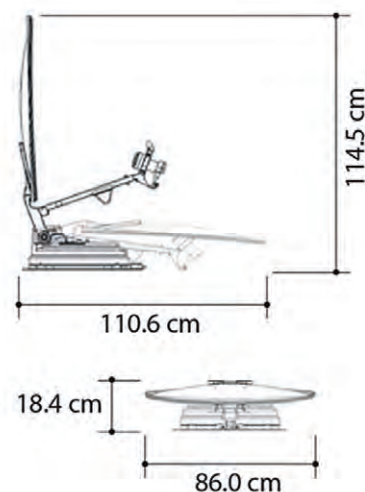
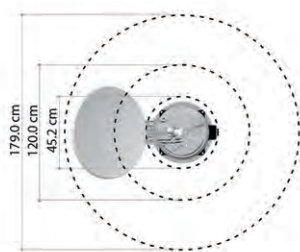





# TRAVELSAT 68 II + 80 II PREMIUM SAT. SYSTEMS WITH BLUETOOTH CONTROL

- **Bluetooth technology for all antennas, control via smartphone**
- **Simple software updates via app, without workshop**
- **Powerful LNBS for excellent TV reception even in outlying areas**
- **Durable rotating mechanism with robust metal and aluminum parts for quiet operation**
- **Technology:** Modern hardware and software technology, updateable and future-proof (HD and DVB-T2).
- **Control unit:** Compatible with all decoders (including Sky HD), reprogrammable without opening the box.
- **Positioning:** GPS-supported, fast satellite search in 30-60 sec. Automatic alignment at touch of a button. Storage of last position, acoustic warning when starting to drive with open antenna.
- **Details:** Aluminum mounting plate for secure attachment, durable steel/bronze gearbox for minimal maintenance.
- **Technical data:** 12V/27W (max. 48W when retracting/extending), -15°C to +50°C, CI slot and OSD.
- **Scope of delivery:** Outdoor antenna, control unit (no receiver), cable, roof feed-through, mounting plate, mounting material, instructions.

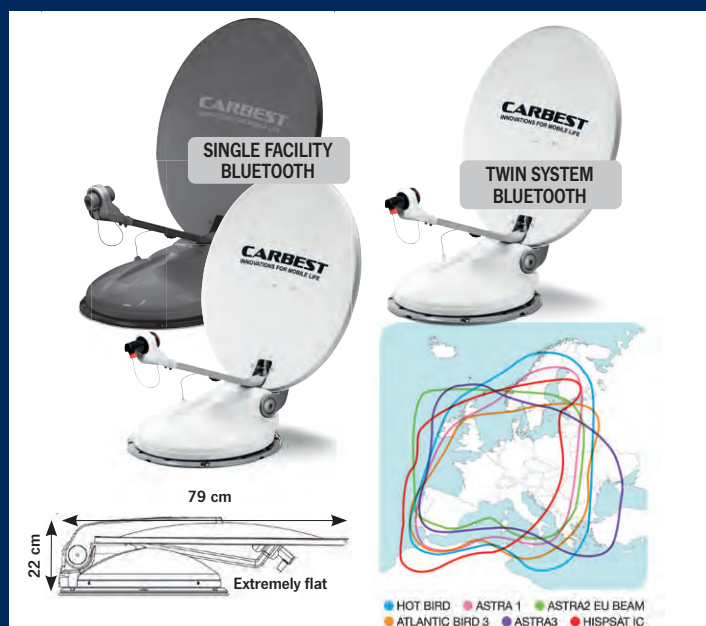

## Travelsat II Ø 68 cm with Bluetooth Convenient control and software updates via app

Travelsat II Ø 68 cm, ASTRA single system (for 1 receiver). All other satellites can be selected via app or control panel. Cable length 5 meters.

Color anthracite	496380	1399,-
Color white	49638	1399,-

Travelsat II Ø 68 cm, ASTRA twin system (for 2 receivers). All other satellites can be selected via app or control panel. Cable length 5 meters.

Color white	49639	1519,-
-------------	-------	--------

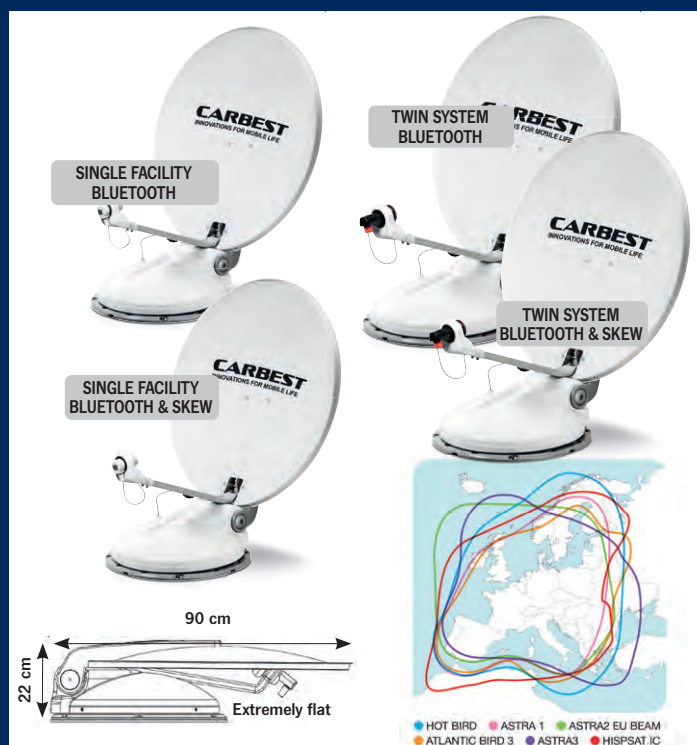

## Travelsat II Ø 80 cm with Bluetooth

Travelsat II Ø 80 cm, ASTRA system with Bluetooth. All other satellites selectable via app or control panel. Cable length: 5 meters.

Single system (for 1 receiver) with Bluetooth	49640	1439,-
Single system (for 1 receiver) w/ Bluetooth & Skew	49641	1860,-
Twin system (for 2 receivers) with Bluetooth	49642	1579,-
Twin system (for 2 receivers) w/ Bluetooth & Skew	49643	2019,-

**TWIN system:** Second SAT connection for an additional digital or HD receiver, enables independent program selection (receiver not included).

**Service:** SR-Mecatronic service network ensures fast repair or replacement, so that the Travelsat is quickly ready for use again.

**Optional control panels:** As an alternative to Bluetooth control, two control panels are available: LED control panel with 7 pre-programmed satellites and the Comfort "Plus" LCD control panel with 15 pre-programmed satellites.



**LED control panel 7 pre-programmed satellites:**  
Hotbird 13E, Astra 19, Thor, Sirius, Atlantic Bird, Hispasat, Astra 28.  
49724 149,-



**Comfort "Plus" LCD control panel. 15 pre-programmed satellites and additional functions:** Hotbird 13E, Astra 19E, Astra 28E, Eurobird 16E, Thor 1W, Sirius 5E, Atlantic Bird 5W, Hispa-sat 30W, Eurobird 9E, Eutelsat 7E, Eutelsat10E, Amos 3W, Atlantic Bird 8W, Atlantic Bird 12W, Astra 23.5E. 49725 179,-

# FULLY AUTOMATIC SAT SYSTEMS

**MEGASAT**  
Brillantes Fernsehen

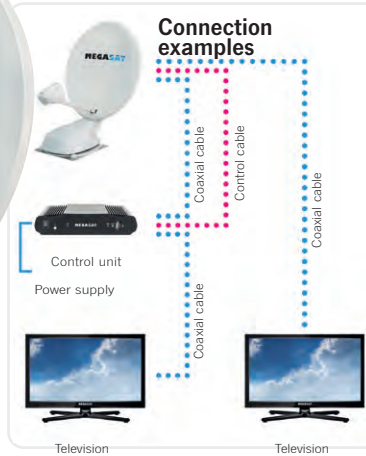

## Caravanman 65 / 85 Premium V2 Caravanman 65 / 85 Professional GPS V2

Best radio and TV quality throughout Europe with the Caravanman. The 65 or 85 cm mirrors ensure ideal reception conditions even in the peripheral areas of the footprint. Another plus point is the low installation height of just 20 cm when retracted, which also allows installation on high vehicles. The included control unit, which now also offers an integrated-Bluetooth® module that can be used to connect to a smartphone or tablet, automatically finds the selected satellite at the touch of a button. The Professional version also offers SKEW function that compensates for reception impairments caused by curvature of the earth.

### Caravanman 65 Premium V2 & Professional GPS V2

- Robust and powerful
- Ideal for smaller vehicles
- Little space required on roof

### Caravanman 85 Premium V2

- Robust and powerful
- For even more reception range
- Low installation height (only 20 cm)

### Caravanman 85 Professional GPS V2

- GPS receiver for quick alignment of antenna
- Professional version with TWIN-LNB
- Automatic SKEW function
- For 2 receivers or TV with SAT receiver
- For even more reception range
- Low installation height (only 20 cm)

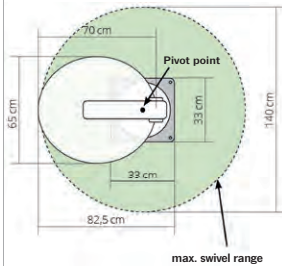

Figure Control panel

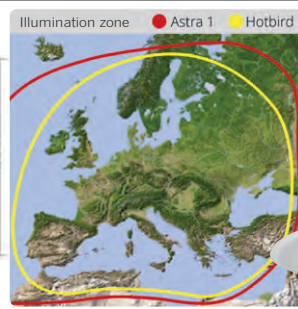
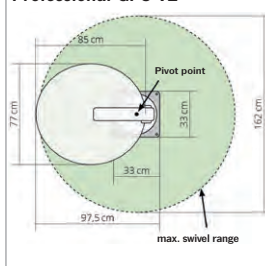

Figure Control unit

#### Caravanman 65 Premium V2/ Professional GPS V2



#### Caravanman 85 Premium V2/ Professional GPS V2



**Compact in height**

Height of the retracted antenna only 20 cm.



Technical data:	① Caravanman 65 Premium V2	② Caravanman 65 Professional GPS V2	③ Caravanman 85 Premium V2	④ Caravanman 85 Professional GPS V2
Number of participants	1	2	1	2
LNB type	Universal Single LNB	Universal TWIN LNB	Universal Single LNB	Universal TWIN LNB
Frequency band/frequency range	Ku Band/10.7 GHz to 12.75 GHz	Ku Band/10.7 GHz to 12.75 GHz	Ku Band/10.7 GHz to 12.75 GHz	Ku Band/10.7 GHz to 12.75 GHz
Signal amplification	35.1 dBi	36.8 dBi	36.8 dBi	36.8 dBi
Reception power	45 dBW	43,5 dBW	43,5 dBW	43,5 dBW
GPS receiver and auto skew	-	Yes	-	Yes
Polarization	H/V			
Motor control / tilt angle / search angle	2 - axis DC motor / 0° to 75° / 360°			
Inclination speed	10° per second			
Rotational speed	20° per second			
Operating temperature	-15° C to +50° C			
Preprogrammed satellites	Astra 1 (19.2° East), Astra 2 (28.2° East), Astra 3 (23.5° East), Hotbird (13° East), Thor (0.8° West), Eutelsat 9 B (9° East)			
Power supply	DC 12-24 V, 10 A			
Antenna dimensions / weight	W 660 x H 200 x D 870 mm / 12.1 kg (net)		W 770 x H 200 x D 1000 mm / 13.3 kg (net)	
Control unit dims. (W/H/D)	W 180 x H 40 x D 130 mm			
Scope of delivery	Antenna, control unit, control panel, connection cable, roof duct, operating instructions			
Art. no.	49843	49844	49845	49846
Price	1299,-	1499,-	1399,-	1699,-





**MEGASAT**  
Brilliantes Fernsehen

**Caravanman Compact 3 w/ Bluetooth function**

- Fully automatic antenna w/ Bluetooth function for operation via mobile, tablet or control unit
- Satellite selection & firmware updates directly via cell phone
- Free app for iOS and Android devices

Caravanman Kompakt 3 is the ideal antenna for caravans, panel vans or motor-homes w/ a small mounting surface. Despite the small mirror, strong reception even in the peripheral regions of Europe. Very compact design with high reception power and 10 pre-programmed satellites. The satellite can be selected either on control unit or via the app on the mobile device. The antenna is connected to the control unit with just one coaxial cable.

**Technical data:**

LNB type: Universal LNB, Frequency band: Ku-band, Input frequency range: 10.7 GHz - 12.75 GHz, Polarization: V/H, Signal gain: 33 dBi @ 12.7 GHz, Minimum EIRP (footprint): 49 dBW, Elevation (tilt): 15° - 62°, Azimuth (rotation): 360°, 2-axis DC motor, Control unit with Bluetooth module, Temp. range: -25°C - +70°C, Power supply: DC 12 volt, dims. when folded: W 46 x H 17 cm.

**Scope of delivery:** Caravanman Kompakt 3, control unit, roof duct, 1m coaxial cable, 10m coaxial cable, operating instructions

<b>Caravanman Compact 3 Graphite Single</b>	<b>498204</b>	<b>1249,-</b>
<b>Caravanman Compact 3 Single</b>	<b>498202</b>	<b>1199,-</b>

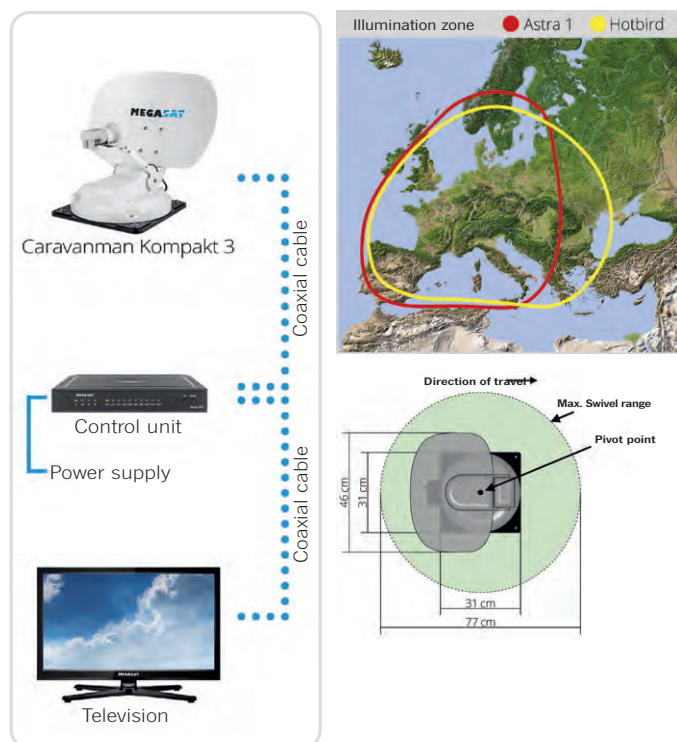

## Oyster® VISION



● Astra 1 ● Hotbird



Reception range Oyster® 65



Reception range Oyster® 85



- Automatic updates
- Simple operation via app
- 65 or 85 cm antenna mirror for pure range
- Fully automatic alignment & satellite detection
- Processing of high-quality and robust materials
- Solid, safe and weather-resistant construction
- Rotary head technology
- LEM technology: Antenna searches at the last set tilt angle (search time reduction)
- Automatic satellite change when changing channels
- Automatic retraction when vehicle is started (terminal 15 must be connected)
- Reliable service
- Type approval mark 10R - 068881
- Dims. Oyster® Ø 65: Ø aerial mirror: 67 cm, turning range: 118 cm. Height/length when folded: 22/92 cm, weight app. 12 kg.
- Dims. Oyster® Ø 85: Ø antenna mirror: 85 cm, rotation range: 150 cm. Height/length when folded: 22/111 cm, weight app. 12 kg.

Oyster® Vision	Item no.	Price
Ø 65 cm Vision Single	49326	2069,-
Ø 85 cm Vision Single	49327	2175,-
Ø 65 cm Vision Single Skew	493262	2335,-
Ø 85 cm Vision Single Skew	493273	2460,-

Oyster® Vision	Item no.	Price
Ø 85 cm Vision Twin	493271	2340,-
Ø 65 cm Vision Twin Skew	493263	2529,-
Ø 85 cm Vision Twin Skew	493272	2635,-



## Oyster® PREMIUM

- Identical features as Oyster® Vision, without control panel
- Benefit from the Premium version: Combine the Oyster® Premium with an Oyster® TV (Smart TV version) and enjoy the advantage of operating the antenna and TV with just one remote control

Oyster® Premium	Item no.	Price
Ø 85 cm Premium Single	49051	2145,-
Ø 85 cm Premium Single Skew	49052	2430,-
Ø 85 cm Premium Twin	49053	2310,-
Ø 85 cm Premium Twin Skew	49054	2605,-

## Oyster® PREMIUM 70

For the company's 30th anniversary, ten Haaft surprises with this system. Like all other Oyster® systems are easy to operate, even via APP, works reliably and fully automatically.



Reception range Oyster® 70

● Astra 1 ● Hotbird

Oyster® 70	Item no.	Price
Vision Single	493260	1790,-
Vision Twin	493264	1945,-
Premium Single	493265	1760,-
Premium Twin	493266	1915,-

Dims. Oyster 70:  
Ø aerial mirror: 67 cm, rotation range: 134 cm.  
Height/length when folded: 17.5/86 cm, weight app. 11.7 kg.

Combine the Oyster 70 Premium antenna with a TV of your choice:

Oyster® Premium & Oyster® TV with just ONE Remote control

Oyster® SMART TV	Item no.	Price
19"	49065	539,-
21,5"	49066	599,-
24"	49067	649,-
27"	49068	749,-





## Oyster® V VISION

- Single-cable technology, w/ control panel (w/o. receiver)
- Control panel for use w/ third-party televisions
- Simple operation & automatic updates via app
- GPS, 3D compass, tilt sensor for fully automatic alignment and satellite detection
- 85 cm antenna mirror for pure range
- Processing of high-quality and robust materials
- Solid, safe and weather-resistant construction
- Rotary head technology
- Automatic satellite change when changing channels
- Automatic retraction when starting the vehicle (terminal 15 must be connected)
- Reliable service
- Type approval mark 10R - 068566

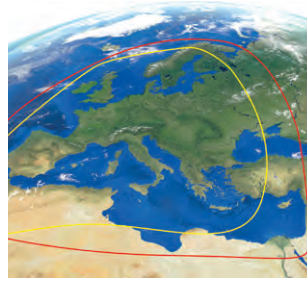

Reception range Oyster® V  
● Astra 1 ● Hotbird



Oyster® V Vision	Color	Item no.	Price
Ø 85 cm Vision Single	white	493274	2635,-
Ø 85 cm Vision Single	anthracite	493278	2635,-
Ø 85 cm Vision Single Skew	white	493275	2925,-
Ø 85 cm Vision Single Skew	anthracite	493279	2925,-
Ø 85 cm Vision Twin	white	493276	2805,-
Ø 85 cm Vision Twin	anthracite	493280	2805,-
Ø 85 cm Vision Twin Skew	white	493277	3095,-
Ø 85 cm Vision Twin Skew	anthracite	493281	3095,-

## Oyster® V PREMIUM

- Features like Oyster® V Vision, without control panel
- Benefit from Premium version:  
Combine Oyster® V Premium with an Oyster® TV (Basic or Smart TV version) and enjoy the advantage of operating the antenna and TV with just one remote control
- Oyster® V Premium antennas & Oyster® TVs are perfectly matched to each other

Oyster® V Premium Base	Color	Item no.	Price
Ø 85 cm Premium Single	white	49095	2605,-
Ø 85 cm Premium Single	anthracite	490951	2605,-
Ø 85 cm Premium Single Skew	white	49063	2895,-
Ø 85 cm Premium Single Skew	anthracite	490631	2895,-
Ø 85 cm Premium Twin	white	49096	2775,-
Ø 85 cm Premium Twin	anthracite	490961	2775,-
Ø 85 cm Premium Twin Skew	white	49064	3065,-
Ø 85 cm Premium Twin Skew	anthracite	490641	3065,-



Dims. Oyster® V Ø 85:  
Ø antenna mirror: 85 cm, rotation range: 193 cm.  
Height/length when folded: 17/113 cm, weight app. 11 kg.

Combine the Oyster® V Premium antenna with a TV of your choice:

Oyster® SMART TV	Item no.	Price
19"	49065	539,-
21,5"	49066	599,-
24"	49067	649,-
27"	49068	749,-



Oyster® V Premium & Oyster® TV with just ONE Remote control



**CAP 750 GPS, CAP 850 GPS incl. control unit**

- The complete package for fully automatic HDTV satellite reception, incl. control unit
- Turntable with integrated control electronics, parabolic reflector with twin LNB and cable set
- Twin LNB for connecting a second receiver or TV set
- The entire turntable can be controlled via a connected receiver or TV set
- Automatic alignment to other satellites when changing channels
- Parabolic reflector w/ LNB pre-mounted on the turntable
- LNB for polarization adjustment manually adjustable
- Automatic lowering (park position) at engine start
- Emergency shutdown in case of overload
- Maximum permissible vehicle speed: 130 km/h
- Aerodynamic body only 21 cm (CAP 750), 17 cm (CAP 850) high (when lowered)
- With GPS for precise location determination
- Quick alignment of the antenna in <1 min.

We reserve right to make technical improvements / changes, as well as to supply a qualitatively comparable product from another manufacturer or supplier in each case. The images are similar to delivered products. Dimensions without guarantee.

Type	CAP 750 GPS	CAP 850 GPS
Diameter	60 cm	85 cm
LNB	2 switchable outputs: V/H (14/18 V) - Low/High (0/22 kHz)	2 switchable outputs: V/H (14/18 V) - Low/High (0/22 kHz)
LNB supply voltage	Vertical: 11.5-14 V, Horizontal: 16-19 V	Vertical: 11.5-14 V, Horizontal: 16-19 V
Input frequency	10.7 - 12.75 GHz	10.7 - 12.75 GHz
Output frequency	950 - 1950/1100 - 2150 MHz	950 - 1950/1100 - 2150 MHz
Oscillator frequency (L.O.)	9.75/10.6 GHz	9.75/10.6 GHz
Supply voltage (car battery)	10,5 - 15,5 V	10,5 - 15,5 V
Consumpt. from 12V on-board power supply: switch-on current/satellite search/TV reception/stand-by	Type. 10 max. 12 A/type. 3 A/Type. 1.2 A/type. 0,024 A	Type. 10 max. 12 A/type. 3 A/Type. 1.2 A/type. 0,024 A
Power consumption from receiver	Type. 160 mA	Type. 160 mA
Elevation/azimuth/skew adjustment range	0-75/370/± 45°	0-65/370/± 45°
Weight of turntable with parabolic reflector	9,7 kg	12 kg
Packaging unit/weight	1/19.5 pc/kg	1/24 pc/kg
Item number	<b>491986</b>	<b>491987</b>
Price	<b>1599,-</b>	<b>1899,-</b>



**WLAN-USB-Adapter UFZ 132 - TV and radio via live streaming**

- Live streaming on mobile devices
- Simple installation via the receiver menu
- Supports 2, 4 and 5 GHz ISM bands (dual band)
- Supports 64-/128-bit WEP, WPA, WPA2 and WAPI encryption

WLAN/USB adapter UFZ 132 enables wireless integration of suitable network-compatible Kathrein receivers into home network; IEEE 802.11n; WLAN hotspot. Thanks to option of setting up a WLAN hotspot, TV and radio broadcasts can also be transmitted to mobile devices (smartphones, tablets, etc.) without an additional Internet router. Simple installation via the receiver menu, no additional software required. Suitable for UFS 946/CI+, UFSconnect 906 and CAP 650/750/850.

49094

39,95







### Easy alignment thanks to extensive equipment

The "Precision" satellite antenna impresses with its easy handling and high functionality. Design of antenna is unique and finding the satellite is child's play thanks to built-in satellite finder, the precisely adjustable elevation and the south mark on leg of tripod. Simply align the marked leg to the south using the compass. The rotation limitation on the tripod only allows a search angle of approx. 30 degrees. The desired satellite is located in this segment.

#### Scope of delivery:

Satellite antenna w/ satellite tripod, integrated satellite finder, compass, universal LNB w/ low noise figure, transport bag for tripod and satellite antenna, 10 m coax connection cable (w/o. receiver).

**Maxview Precision 65 cm with Single LNB 496654 369,-**

#### Maxview Precision I.D. 65 cm with Twin LNB

Identical to Precision 65, but with satellite identification module. This allows the antenna to be aligned in a matter of seconds. The blue LED display confirms that you are on the satellite selected in the receiver.

**496657 479,-**



### Portable Kit Light with tripod and bag

- Skew adjustment scale
- Universal LNB (retractable arm)
- With 54 cm or 65 cm satellite mirror

Complete satellite package from Maxview includes everything you need for reception: elliptically shaped satellite mirror (54 cm or 64 cm), satellite tripod, compass, satellite finder, coax cable w/ F-connectors & a practical carrying bag. All you need is a TV set and a receiver or a TV with an integrated satellite receiver. High stability. Universal, rotatable pole mount. Precise degree graduation and skew adjustment scale facilitate alignment. Universal LNB specially tuned. Only 4.5 kg light. Scope of delivery: Mirror, aluminum tripod, satellite finder, LNB, satellite compass, connection cable, carrying bag.

**65 cm mirror 49765 239,-**



### Antenna set HDS 166 Plus

- Consisting of BAS 66 flat antenna (twin LNB), satellite tripod, adapter joint, UFZ 131, CAP converter, 15m coaxial cable, appl. note
- Set up in a few simple steps
- Guided alignment via smartphone using voice assistant
- 11 satellites preset
- Twin LNB for connecting a second receiver or TV set
- Streaming of TV/radio programs to mobile devices

The HDS 166 Plus antenna can be conveniently aligned to the desired satellite using a smartphone (with compass and Wasserwagen app). Scope of delivery: BAS 66 flat antenna, HDS 100 satellite tripod, adapter joint, CAP converter, UFZ 132, 15m coaxial cable, carrying bag, installation instructions. Weight: approx. 9.4 kg

**49124 599,-**

### Antenna set HDS 166

- Consisting of HDS 100 satellite tripod - BAS 66 flat antenna, adapter joint, 15 m coax. cable
- Set up in a few simple steps
- Simple alignment of the antenna with the aid of a smartphone
- Very little space required for transport
- Twin LNB for connecting a second receiver or TV set

HDS 166 antenna set for manual satellite reception is an excellent alternative to the fully automatic, permanently mounted turntable. The BAS 66 flat antenna included in the set is ideal for adjusting and searching for satellites using a smartphone and a compass app. Scope of delivery: BAS 66 flat antenna, satellite tripod for variable positioning of the BAS 66 and KEA 650 satellite antennas. Adapter joint, 15 m coaxial cable, carrying bag, installation instructions. Weight: app. 8.8 kg

**49121 389,-**





- 12V  
24V
- SINGLE LNB
- 4 SATELLITE PRE-PROGRAMMED
- 1-CABLE CONNECTION
- WITH THEFT-SECURITY



## Snipe Handy 1-cable connection

Portable satellite antenna incl. theft protection

- Perfect for mobile use: antenna can be placed anywhere with a clear view of satellite
- Single LNB, 4 satellites pre-programmed (Astra1, Astra2, Hotbird, Eutelsat 5W)
- 1-cable solution: Receiver connection & power supply to antenna via 1 coaxial cable
- Integrated theft protection (optical & acoustic)

1-cable connection: Connection of antenna to controller incl. power transmission via 1 coaxial cable. Metal eyelet for attaching a steel cable (not included) to prevent theft. In addition, acoustic warning signal in case of non-permitted removal of the coaxial cable. Robust plastic cover provides best possible protection against the weather.

Satellite search time: app. 180 sec., power consumption: 30W. Signal amplification: 31 dBi, Reception power: 51 dBW, Search angle: 15° - 90°/360°, App. dims.: Ø 450mm, H 390 mm. Scope of delivery: Antenna incl. remote control, controller w/ holder & power cable w/ cigarette lighter plug, 10m coaxial cable, operating instructions. Weight: 7.6 kg.

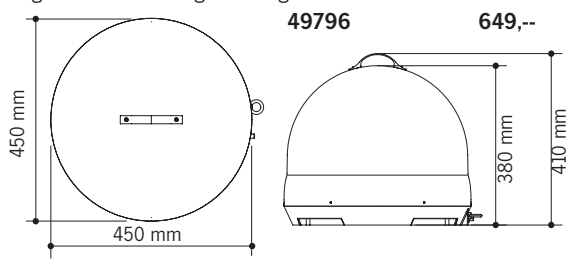
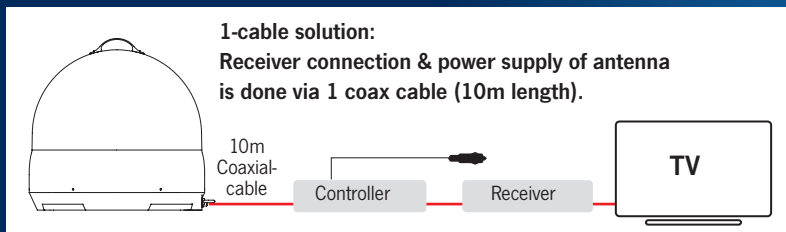
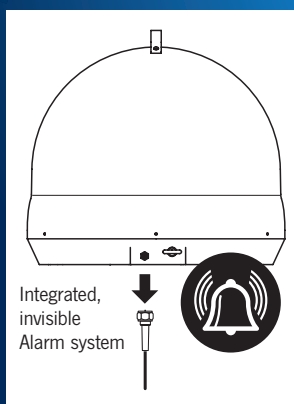
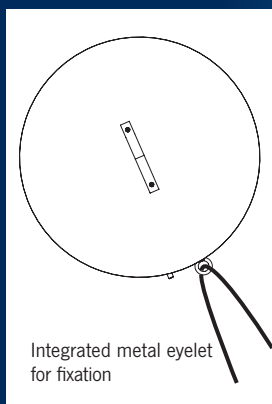

## MAXVIEW VuQUBE II

Portable satellite antenna w/ automatic alignment - also for fixed mounting!

- With Twin LNB
- Receiver independent
- Fully automatic satellite search in 60-90 seconds
- No assembly necessary: Set up, search for satellite, done

Lightweight and portable. With 2 receiver connections. Dynamic leveling, compensates for unevenness. Dimensions H46 x L42 cm. Weight 4.5 kg

**VuQube Auto 2 w/ automatic satellite search.**

Scope of delivery: Antenna, control unit, 1x10m cable, instructions.

- ① VuQube Auto 2 496555 1069,-
- ② Roof mounting kit 496556 44,95
- ③ Tripod for VuQube antenna made of aluminum Dims. unfolded: H85 x W120 cm, Dims. folded: H80 x W17 cm, Weight: 1890g 496558 109,-
- ④ VuQube padded transport bag for safe storage 496557 56,95



**MEGASAT**  
Brillantes Fernsehen

**Campingman Portable ECO - the energy saver**

- Parabolic antenna with universal LNB
- No separate control unit required
- The plastic cover provides the best possible protection against weathering and damage
- No more updates required for transponder changes
- Can be set up in any location (e.g. floor, roof, table...)

Antenna does not require a separate control unit. The coaxial cable is connected directly to TV or receiver. Antenna is also supplied w/ power from there. All you have to do is switch on your TV or receiver & the antenna will automatically search for satellite (pre-programmed for Astra 1). The antenna is suitable for 1 subscriber. Dims. Ø 450 mm x H 430 mm. Weight 4.2 kg. Scope of delivery: Campingman Portable (ECO/ECO Graphite/ECO Multi Sat), coaxial cable, operating instructions

Campingman Portable ECO	492940	799,-
Campingman Portable ECO Graphite	492950	829,-

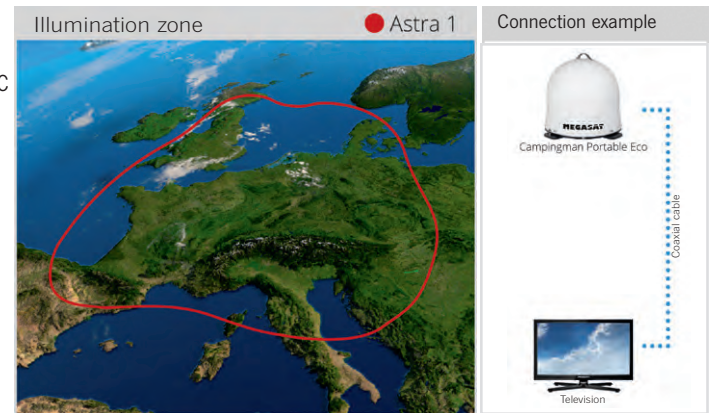

**MEGASAT forstet auf**  
Pro verkauftem Campingman Portable Eco pflanzt Megasat einen Baum in der Rhön.

**Technical data:** LNB type: Universal LNB, Frequency band: Ku-band, Input frequency range: 10.7 - 12.75 GHz, Polarization: V/H, Signal gain: 31 dBi at 12.7 GHz, Minimum EIRP (footprint): 51 dBW, Elevation (tilt): 23° - 43°, Azimuth (rotation): 360°, 1.5-axis DC motor, Control unit w/ Bluetooth module, Temp. range: -20°C - +70°C, Power supply: DC 12 Volt, Mirror size: 380 (Ø)

**MEGASAT**  
Brillantes Fernsehen



**Campingman Portable 4**

- Mini control unit with 5 programmed satellites
- Auto-skew function with twin connection
- Plastic cover against weather influences and external damage

The mobile, fully automatic satellite antenna offers flexible positioning options and searches for selected satellite at touch of a button. Protected from the weather by a plastic cover and equipped with auto-skew for optimum polarization, it ensures first-class reception in Europe. It is suitable for two subscribers without transponder updates.

492952	999,-
--------	-------

**Technical data:** Parabolic antenna, universal LNB, max. 2 subscribers, Ku frequency band, input frequency range: 10.7-12.75 GHz, V/H polarization, signal gain: 32.6 dBi @ 12.7 GHz, minimum EIRP (footprint): 48 dBW, elevation: 15° - 50°, azimuth (rotation): 360°, 2-axis DC motor, Mini control unit with 5 programmed satellites (no transponder updates required), Free app for iOS and Android, Temperature range: -25°C to 70°C, DC 12 volt, Mirror size: Ø 380 mm

**TELECO**  
SAT EQUIPMENT



**WING-LAN11 DVBT/T2, DAB+ and Internet antenna 3G/4G/5G**

- Internet antenna 2G-3G-4G-5G
- Omnidirectional TV antenna with DAB+ radio

WING-LAN11 integrates a TV omni-directional antenna for digital terrestrial signals DVBT/T2 and radio signals DAB+ with a highly efficient internet antenna for 2G-3G-4G-5G signals. Connected to the TELECO router (Art. No.491944), a WLAN WiFi hotspot is created so that you can navigate the Internet and watch your favorite shows via streaming. Technical data: Channels: 5-12 / 21-48, gain with amplifier: CH 5-12 16 dB, CH 21-48 26 dB Dimensions: Diameter: 38 cm, height: 16.5 cm. Weight: 1,2kg

Scope of delivery: 1 antenna complete with 5 m DVBT/T2 coaxial cable, 5 m SMA 2G-3G-4G-5G coaxial cable and 3 F-connectors; 1 amplifier with adjustable gain with 3 outputs for 3 TVs + 1 DAB and FM radio output, 12 and 24 V DC operation.

491943	360,-
--------	-------



### Portable 12-volt router with WLAN repeater – WLT24EX2

- **Uncomplicated Internet access in the motorhome:** Easy to integrate into vehicle, ideal for on the go
- **Versatile use:** Web surfing, music, videos and TV streaming as well as access to home and company networks possible
- **Fast and stable Internet access:** high-performance router ensures a stable connection
- **Simple operation:** can be controlled via smartphone
- **Internet use of up to 4 devices simultaneously possible**

The portable 12V router with WLAN repeater is able to convert any mobile radio signal into WLAN using a data SIM card (not included). It is compatible with all mobile radio frequencies (LTE/4G/3G).

The router is also equipped with a Wi-Fi signal repeater function and transmits the Wi-Fi signal from nearby sources back into the vehicle

491944 64,90

Technical data	
Reception frequencies	800 MHz (B20), 900 MHz (B8), 1800 MHz (B3), 2100 MHz (B1), 2600 MHz (B7)
Antennas	2 internal antennas for 3G, 4G, LTE, Wi-Fi
WIFI	Integrated WLAN repeater signal amplifier
Connections	2 SMA connectors for external antennas
SIM cards	2 SIM card reader integrated
Network	1 Ethernet input
LTE specifications	LTE category 4
LTE speed	Download: 150 Mbps, Upload: 50 Mbps
Power supply	DC 10.5 - 14.5 V, 1 A
Dimensions	151 mm x 150 mm x 48 mm



### MAXVIEW ROAM COMBO & ROAM COMBO X

- **360° all-round reception**
- **High-quality, aerodynamic design**
- **Compact design**
- **5G compatibility: ideal for home office in the vehicle**
- **Simple installation**

The Roam Combo antenna is designed for maximum flexibility and performance in mobile use. Thanks to 360° omnidirectional reception, it does not need to be aligned and therefore offers convenient, fast operation. With its high-quality, flat and aerodynamic design, it combines style and functionality - ideal for stable reception while driving. Despite its compact size, the Roam Combo antenna takes up very little space and can be flexibly installed almost anywhere on the roof. In addition, 5G compatibility enables the use of the latest mobile radio standards and ensures future-proof data transmission. The special mounting base makes installation simple and safe, with only a single hole required to guide the cables into the vehicle interior. The Roam Combo is therefore the ideal solution for anyone who values reliability, modern design and high-performance reception.

- ① Roam Combo White 49873 629,-
- ① Roam Combo anthracite 49876 629,-
- ② Roam X Combo White 49874 1099,-
- ② Roam X Combo Anthracite 49877 1099,-

Technical data	Router Roam X	Router Roam
Router type	LTE and WiFi	LTE and WiFi
Speed	up to 300 Mbps	up to 150 Mbps
Number of connections	up to 50 devices	up to 50 devices
Power consumption	<5 W	<5 W
SIM card	freely selectable	freely selectable
Dims. (HxWxD)	83 x 74 x 25 mm	83 x 74 x 25 mm
Weight	125 g	125 g

Technical data	Roam Combo antenna 4G/5G
Antenna type	Omnidirectional antenna MIMO
Frequency	698MHz to 6000MHz
Gain range	5.9 - 8.8 dBi
Cable length	0,8 m
Power supply	None
Dimensions	H: 194 W: 356 D: 311mm
Weight	995 g



## ROAM Internet antenna

- Internal reception while driving & when stationary
- Router incl. wall mount receives 3G/4G & WiFi signals
- For up to 50 end devices/users
- Hotspot function for your own home network
- Unlocked for every SIM card
- Roof mounting available as an accessory

Powerful mobile internet antenna, designed to receive a maximum 3G/4G/5G signal. In combination with the LTE router, a secure and reliable hotspot is created in your vehicle. The supplied router is able to receive 3G/4G and WiFi signals; it is set to LTE reception on delivery. (but can be switched to WiFi reception if required)

Technical data	① WiFi omnidirectional antenna for motorhomes	② + ③ WiFi antenna for panel vans	Tec. data	Router
Antenna type	Omnidirectional antenna MIMO		Router type	LTE and WiFi
Frequency	698MHz to 6000MHz		Speed	up to 150 Mbps
Gain range	5.9 - 8.8 dBi		Number of connections	up to 50 devices
Cable length	0,8 m		Power consumption	<5 W
Material	Aluminum base plate, UV-stable ASA cover		SIM card	freely selectable
Dimensions	Ø 196 mm, height: 65 mm	HxWxD: 65x180x60 mm	Dims. (HxWxD)	83 x 74 x 25 mm
Weight	386 g	500 g	Weight	125 g

**Scope of delivery:** Roam LTE antenna, LTE/WiFi router, 12 V connector plug, 230 V, mains adapter, router wall mount, 2 m cable with SMA connectors, instructions.

- |   |       |       |
|---|-------|-------|
| ① WiFi omnidirectional antenna white for motorhomes   | 49637 | 499,- |
| ② WiFi antenna white for panel van  | 49856 | 499,- |
| ③ WiFi antenna black for panel van  | 49857 | 499,- |
| ④ Roof bracket incl. 3m cable and roof bushing:<br>(If there is no possibility to lead cables directly underneath antenna into vehicle) |       |       |
| White aluminum roof bracket for motorhomes  | 49764 | 64,90 |
| White aluminum roof bracket for panel van   | 49860 | 64,90 |
| Black aluminum roof bracket for panel van   | 49861 | 64,90 |



With app control

## MAXVIEW ROAM

5G

For motorhomes



5G READY ANTENNA

For panel vans



②



③

Further information at [www.reimo.com](http://www.reimo.com)

④ Roof bracket set



## Camper Connected 5G Ready

- Powerful 4G/5G antenna: 2.4/5 GHz WiFi system
- Efficient LTE router: 2.4/5 GHz WiFi system
- Removable mounting plate
- MIMO LTE/5G; 2x2 MIMO WiFi (Multiple Input Multiple Output)  
Enables optimal reception through simultaneous parallel connection with two or more antennas and cell towers.
- LAN connection (10/100 Mbps)
- 3x antenna sockets 3x (SMA)
- 2x SIM card slot
- up to 60 Wifi users
- Encryption to protect your data
- Firewall security system

The Camper 5G ready Wifi system combines a powerful outdoor unit with an equally powerful CAT6 router. Increases performance of the mobile signal to a maximum and ensures interference-free internet reception. With the Camper 4G ready system, the 4G/LTE/WiFi radio signal is now amplified inside the vehicle, ensuring the best Internet reception in high Wi-Fi quality.

Technical data: Voltage: 12V, power consumption: 5W to max. 12W, Antenna dimensions: (W/H/D) 98 x 98 x 75 mm, weight approx. 480 g Router dims.(W/H/D): 145 mm x 100 mm x 29 mm, weight: 250g.

Scope of delivery: LTE 5G/WiFi 2.4/5.8GHz outdoor antenna; connection cable for antenna & router (3 m); mounting plate and roof duct; router incl. antenna and 230V/12VDC power supply unit; 12 V car connection cable; operating instr.

49129

59,90

**MEGASAT**  
Brillantes Fernsehen

5G

NEW



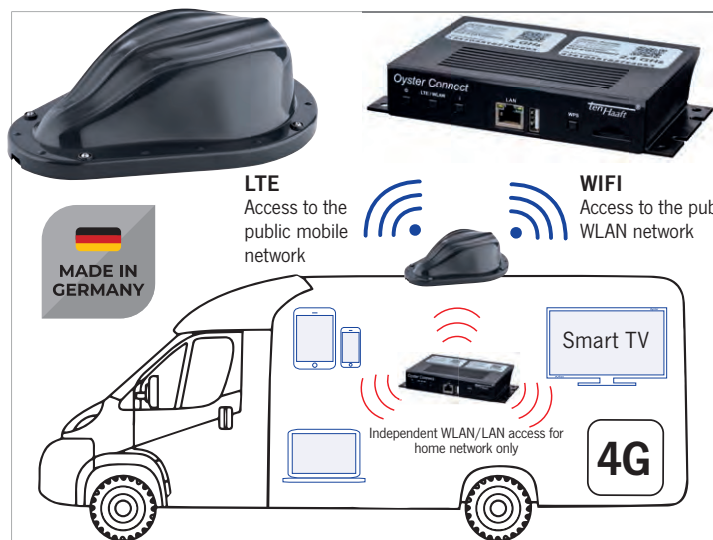

## Oyster® CONNECT VISION

Mobile Internet like at home, even while driving

- Powerful WLAN and LTE antenna (4G)
- One-off & simple setup of "mobile home network"
- LTE module optimized for use in the EMEA region, worldwide use on compatible frequencies is also possible
- 2 SIM card readers (dual SIM)
- 3 WLAN modules for 2.4 GHz and 5 GHz dual-band WLAN in the vehicle and connection to external WLAN hotspots outside the vehicle
- Support for hotspots with captive portal websites
- Simple registration of your end devices to WLAN of Oyster® control units via QR codes and WPS
- All your carried devices can be in the mobile home network of the Oyster® control units at the same time
- Dynamic temperature control
- Convenient operation via intuitive web interface in DE / EN / FR / ES / IT / NL

Dims.: LxWxH 405x292x120 mm, weight: 1.5 kg. Scope of delivery: Oyster® Connect Vision antenna, indoor unit, roof feed-through with 4 m data cable, power connection cable, mounting plate.

Product	Item no.	Price
Oyster® Connect Vision	49035	995,-

Combine the Oyster® Connect Vision antenna with a desired Oyster® Smart TV: You can find these on page 852

## Oyster® ACCESS

Oyster® Access outdoor antenna

- Full-size antenna with separate roof feed-through for antenna cables
- 2x LTE all-band antenna with Diversity technology
- 4x WLAN antenna for 2.4 GHz and 5 GHz MIMO
- 4x high quality antenna cable in protective sleeve, detachable on both sides, 2 meters
- Antenna dims.: Ø 30.5 cm x 13.0 cm, mounting hole ø 18-20 mm
- Incl. Router (see below for technical details)



Product	Item no.	Price
Oyster® Access Vision	490350	879,-

## Oyster® EASYNET

Oyster® EasyNet outdoor antenna

- Space-saving hemispherical outdoor antenna with integrated cable feed-through
- Compact antenna with 2x LTE and 2x WLAN MIMO
- 4x low-loss antenna cable, permanently connected on antenna side, 1.5 meters
- Thread length 27 or 45 mm available
- Antenna dimensions: Ø 11 cm x 5.5 cm, mounting holeø 28 mm
- Incl. Router (see below for technical details)



Product	Item no.	Price
Oyster® EasyNet V1 - 27 mm	490351	799,-
Oyster® EasyNet V1 - 45 mm	490352	799,-

## Oyster® Access / Oyster EasyNet Router

- 2.4 GHz + 5 GHz dual-band WLAN for the private network
- LAN connection for the private network
- 2.4 / 5 GHz WLAN module for connection to an external WLAN via external antenna
- LTE module for use in the EMEA region
- Two SIM card readers
- Worldwide use
- On compatible frequencies is also possible
- Login of up to 250 end devices possible
- Router dims.: 17.5 x 4 x 9.3 cm
- - Convenient operation via intuitive web interface in DE / EN / FR / ES / IT / NL



2 x sim card reader

Smartphone not incl. in scope of delivery

## Oyster® Multimedia packages



### Oyster® Multimedia - Base package

Oyster Multimedia package consists of: Satellite antenna Oyster® 70 Premium Base (catalog page 852), Oyster® Smart TV 21.5" (catalog page 852) Internet antenna Oyster® EasyNet V1 - 45 (catalog page 860) 493300 2490,-

### Oyster® Multimedia Package Pro

Oyster Multimedia Package Pro - Package consists of: Satellite antenna Oyster® V Premium Base Twin Skew (catalog page 852), Oyster® Smart TV 24" (catalog page 852), Internet antenna Oyster® Access (catalog page 860) 493301 3490,-



## Pioneer Router WR204 incl. antenna

- 2G, 3G, 4G LTE
- 2.4GHz and 5GHz WLAN
- For up to 32 devices
- **lwLAN antenna integrated in housing**
- **Additional WLAN via external antenna**
- 2x LAN port / 2x SIM slot

Technical data	
SIM slot	2 x SIM slot (nano-SIM)
Mobile radio standards	2G, 3G, 4G LTE
WLAN frequencies	2.4 GHz and 5 GHz WLAN
WLAN antenna	WLAN antenna integrated in housing
External antenna	"Shark fin" antenna incl. in scope of delivery
LAN ports	2 x LAN port
Speed	Download 150 Mbit/s max, upload 50 Mbit/s max (CAT4)
Repeater function / captive hotspot	Search for WWAN SSID, scroll & password entry, automatic link to hotspot landing page
User interface	Web-based user interface (simple or expert mode)
Operation	Via smartphone, tablet or PC/Mac
Guest access	Configurable, data rate limitable
On/Off	Via timer or mechanical switch
Power supply	0.5 A/12 V (8-18 V)
Operating temperature	-20 to +60 °C
Mounting	Ultra-compact, antenna can be mounted on profiled roofs (e.g. Ducato)

49160

599,--



## Camping router 4G CAR 150 WiFi Duo

- Two SIM card slots
- 12 V or 230 V power supply possible
- LTE antenna (4G)

Internet reception also available while driving and internationally. Use of existing WLANs, e.g. campsite/restaurants/hotspots MIMO outdoor antenna for perfect LTE/WLAN reception. Future-proof thanks to update option via the Internet. 12 V or 230 V power supply possible. 5 x antenna, 4 x Ethernet, 1 x USB connection and many other connections. Router dimensions WxH: 109x50 mm. Antenna dimensions Ø 110 x H 55 mm. Weight: 295g

**Scope of delivery:** Roof antenna, 12 V connection cable, roof feed-through w/ fastening screw w/ knurled nut, network cable (1.5 m), 230 V-12 V power supply unit.

49130

499,--



4G

KATHREIN

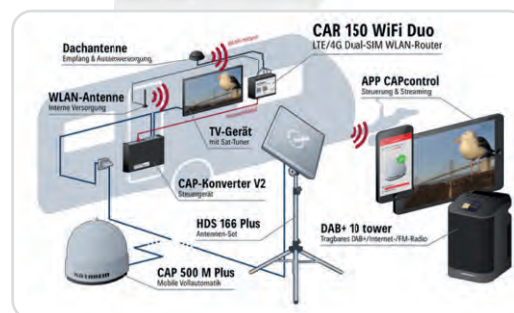

## Camping router CAR 160 WiFi Duo 5G MIMO

- LTE/5G MIMO antenna (black or white)
- Two SIM card slots
- 12 V or 230 V power supply possible

The CAR 160 WiFi Duo 5G MIMO dual SIM WLAN router set enables the connection of mobile devices (cell phone, tablet, notebook) to the Internet via an existing WLAN or the mobile data of an inserted SIM card.

### Technical data:

Connections: 2 x SMA for LTE, 2 x RP-SMA for WLAN, 1 x SMA for GPS, 3 x LAN, 1 x WAN, 1 x USB host; mobile radio standards: 4G/LTE (Cat. 4), 3G, 2G; Input voltage range: 9 - 30 V; Power consumption: 2 W; Router dims.: W109 x H50 x D103 mm. Antenna dimensions Ø 110 x H 55 mm. Weight: 295 g

**Scope of delivery:** Router, internal WLAN antenna, 230 V power supply unit, Ethernet cable 1.5 m, roof antenna, roof feed-through w/ fastening screw w/ knurled nut, 12 V connection cable, operating instructions

Car 160 Duo Black  
Car 160 Duo White

49147

629,--

49148

629,--



## INTERNET ANTENNAS



① **CAMPERNET 2.0 EVO** - LTE category CAT12: downl. rate max. 600 Mbit/s, upload rate max. 150 Mbit/s; connection mobile radio 2 x 2 MIMO (FAKRA), 5G ready: upgradeable to PRO version; L176 x W134 x H35 mm, weight: 320 g  
**49161 649,-**

② **CAMPERNET 2.0 Pro** - 5G NSA + 5G SA mobile networks: Download rate max. 3400 Mbit/s, upload rate max. 900 Mbit/s; LTE category CAT19: Download rate max. 1600 Mbit/s, upload rate max. 200 Mbit/s; connection mobile radio 4 x 4 MIMO (FAKRA); dimensions L176 x W134 x H35 mm, weight: 340 g  
**49162 999,-**

③ **Roof antennas:** Suitable for metal or GRP roofs, no ground tarpaulin required. Dims.: L173 x W161 x H98 mm

**Suitable for CAMPERNET 2.0 EVO:**

**Mobile radio MIMO 2x2, WLAN 2x2, Color: White** **49165 199,-**

**Suitable for CAMPERNET 2.0 Pro:**

**Mobile radio MIMO 4x4, WLAN 2x2, Color: White** **49166 269,-**

**Mobile radio MIMO 4x4, WLAN 2x2, color: black** **49167 269,-**

④ **Roof fins:** Suitable for metal roofs (e.g. panel vans or aluminum roofs).

Dimensions: L200 x W60 x H75 mm. Suitable for CAMPERNET 2.0 EVO and PRO.

**Mobile radio MIMO 2x2, WLAN 2x2, color: white** **49163 159,-**

**Mobile radio MIMO 2x2, WLAN 2x2, color: black** **49164 159,-**

⑤ **foil antenna:** Easy installation by sticking from the inside without drilling holes. Mobile radio MIMO 2x2. Mounting: 3M adhesive surface, dims.: 207 x 177 x 5 mm.  
**49168 129,-**

## CAMPERNET –

### Brings Internet to your motorhome



- **Simple Internet access and easily into Motorhome integrated i**
- **Versatile use: Web surfing, music, videos and TV streaming as well as access to home and company networks possible**
- **Fast and stable Internet access: high-performance router ensures a stable connection**
- **Simple operation: can be controlled via smartphone**

Whether for private or business use - with the CAMPERNET 2.0 routers, online access in the motorhome is uncomplicated. Surfing, streaming music, videos and TV or accessing the home network - CAMPERNET 2.0 offers fast, stable Internet access. Antretter & Huber, specialist for Internet in motorhomes, presents latest 5G/LTE/WLAN high-performance routers: the CAMPERNET 2.0 EVO (5G ready) with LTE CAT12, WiFi6 and WPA3 as well as the CAMPERNET 2.0 PRO (5G) for higher demands. Both routers are specially designed for motorhomes, easy to install and simple to operate via smartphone. Dims.: L176 x W134 x H35 mm, weight: 320 g.

Technical data	
SIM slot	2 x Micro SIM slot for mobile phone cards
Card change	Tool-free card change (push mechanism)
APN recognition	Automatic recognition for over 180 providers
Operation	WebApp user interface, child's play
WIFI	WiFi6, 2.4 GHz / 5 GHz, WPA3
WLAN connection	2 x 2 MIMO (FAKRA Code K)
WLAN antenna	Integrated indoor WLAN antenna: 2 x 2 MIMO
WLAN repeating	Support for public WLAN networks (Captive Portal)
WLAN speed	5 GHz: 2 x 2 MU-MIMO 1200 Mbit/s, 2.4 GHz: 2 x 2 MU-MIMO 573.5 Mbit/s
Guest WLAN	Adjustable data limit
Automatic mode	Automatic switching between WLAN and mobile radio
Data saving mode	Can be switched on
Secure connections	Support for VPN and SSH connections
Updates	Automatic over-the-air updates
Voltage	9 V to 30 V (12 V / 24 V system)

4G



## alphatronics

### STREAM - Internet solution for on the go!

- **Simple assembly**
- **Easy app operation**
- **Two SIM card slots**
- **Keep an eye on your data consumption**
- **Perfect addition for your alphatronics Smart-TV**
- **Power supply via 12V connection cable / 230V power supply unit**

The alphatronics STREAM is a mobile router that offers flexible Internet for smartphones, tablets, laptops and smart TVs. With four antennas and an automotive-certified router, it is easy to set up and manage via the web app. Ideal for motorhomes and caravans, the router is European made and factory unlocked for any SIM card, supports all data service providers and offers options for Pay As You Go or monthly contracts. Advanced password encryption ensures secure connections. It can connect up to 150 devices simultaneously and offers customized website filters. The wall bracket ensures a clean installation. The router comes with a 12 V connection cable or optional 230 V power supply and includes accessories such as antennas and LAN cables.

Scope of delivery Stream:



Scope of delivery Stream2:



Product overview	Stream	Stream2
Suitable for	Standard user (up to 3 devices at same time)	Mob. office or family (up to 5 devices at the same time)
Speed (Download)	up to 150 Mbit/s	up to 300 Mbit/s
Standard	CAT4	CAT6
Number of SIM slots	4G, 3G, 2G	4G, 3G, 2G
Mobile networks	2x	2x
Automatic SIM configuration	Yes	Yes
SIM slot circuit	SIM1 or SIM2	SIM1 or SIM2
Use in	Europe, Middle East, Africa	Europe, Middle East, Africa, Australia
Network speed	2.4 GHz	2.4 GHz / 5.0 GHz
LAN connections	4x	4x
Item number	<b>497018</b>	<b>497019</b>
Price	<b>499,-</b>	<b>689,-</b>



**Camper Connected 5G (LTE and WiFi system) – Best Internet reception for all common mobile devices & smart TVs.**



- LTE/5G + 2.4G / 5.8G WiFi + GPS + DAB antenna
- Gain: 2-5 dBi; Impedance: 50 dB
- Transmission rate 2.4 G to 300 Mbps and 5.8G to 867 Mbps
- GPS tacking to localize the vehicle
- 3x LAN connection, 1x WAN connection
- 1x USB 3.0 data interface
- 2x SIM card slot
- Encryption to protect your data
- Firewall security system
- Power consumption: 5 watts to max. 20 watts

Megasat Camper Connected 5G WiFi system combines a powerful outdoor unit w/ an equally powerful CAT20 router. It increases the performance of the mobile phone signal to a maximum and ensures interference-free Internet reception.

With Camper Connected 5G, a radio signal is now amplified inside the vehicle, ensuring the best Internet reception in high Wi-Fi quality. The integrated GPS antenna allows you to call up the location of your vehicle at any time.

The outdoor antenna also has a DAB+ antenna connection to provide the best reception for DAB+ devices.

497008 899,-

**Scope of delivery:** LTE 5G/WiFi 2.4/5.8G outdoor antenna, connection cable for antenna & router (3 m), mounting plate & roof duct, router incl. antenna and 12 V power supply unit, 12 V car connection cable, operating instr.

**Technical data router:**

LTE/5G WiFi router + 2.4/5.8GHz WLAN, GPS tacking for localizing the vehicle, CAT20 standard, 4x4 MIMO (Multiple Input Multiple Output) Enables optimum reception through simultaneous parallel connection with two or more antennas to mobile phone masts, 3x LAN connection, 1x WAN connection, 1x USB 3.0 interface, 8x antenna socket (SMA), 2x SIM card slot, up to 150 WiFi users, encryption to protect your data, firewall security system, support for international SIM cards (Auto APN), aluminum housing incl. bracket, power consumption: 5 watts to max. 20 watts. Dims. (W/H/D) 124 x 44 x 113 mm, weight: app. 470 g.

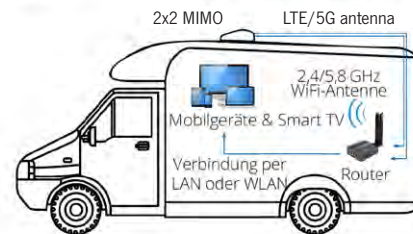

899,-

**Technical data antenna:**

LTE/5G + 2.4G / 5.8G WiFi + GPS + DAB antenna, frequency range: LTE/5G: 614-960 MHz / 1710-2300 MHz / 2500-2700 MHz / 3300-4500MHz; WiFi: 2400-2599/5100-5900MHz; DAB:170-230 MHz; Gain: 2-5 dBi; Impedance: 50 dB, Omni-directional radiation pattern; Polarization: Linear Vertical, Max. power: 50 watts, Antenna cable: 4x RG316, 1x RG174 3 m, Connection: 4x SMA / Fakar, Removable mounting plate, Dims. (W/H/D) 252 x 215 x 95 mm, Weight: app. 750 g.

**AMR104X – Super-fast mobile Internet solution CAT 6 with 4G dual SIM**

- 4-element antenna with high gain
- 3G/4G/5G compatible antenna
- MiMo omnidirectional antenna with flat profile
- Mobile 4G CAT 6 LTE router (generally . twice the speed of standard CAT 4 device of up to 300 Mbps)
- Fast, reliable internet access for streaming and surfing
- Dual SIM
- 2.8" LED color screen
- On/off power switch
- Simultaneous connection of multiple devices
- Remote management system support
- Simple mounting solution
- 12/24 V
- E-mark



4G NEW

Stream, browse, share - with the brand new, super-fast Avtex AMR104X CAT6 router and 4-element antenna package. Designed specifically for the leisure market, the AMR104X features a 2.8" color screen that allows you to easily monitor the status of your router and view information such as signal strength, service provider and even monthly data usage. The dual SIM router is unlocked for all networks and even offers the user the ability to switch between LTE and WiFi to minimize roaming costs. The antenna uses the latest technology to fully support 3G, 4G and 5G. The AMR104X has a DC circuit breaker that allows the router to be switched off when not in use to minimize battery consumption.

Color Antenna White	49887	699,-
Color Antenna Black	49888	699,-

# HD STICKS/SAT RECEIVER/SAT FINDER

**MEGASAT**  
Brilliantes Fernsehen



Outdoor unit  
(antenna with integrated router)

4G



Connections to outdoor unit



Indoor unit (router)

## Connected WiFi Booster

- Powerful 4G/5G antenna: 2.4/5 GHz WiFi system
- Efficient LTE router: 2.4/5 GHz WiFi system
- Gain: 5 dBi; Impedance: 50 dB
- Transmission rate 2.4 to 5.8 GHz up to 750 Mbps
- 2x Fast Ethernet 10/100M port 1x with PoE output
- USB-C connection for Internet via smartphone (USB tethering)
- up to 60 Wifi users
- Encryption to protect your data, firewall

The Megasat Connected WiFi-Booster System combines a powerful outdoor unit with an equally powerful WiFi router. Increases performance of WiFi signal to a maximum and ensures interference-free Internet reception. With the Megasat Connected WiFi-BOOSTER5G, the radio signal is now amplified inside the vehicle and thus ensures the best Internet reception in high WiFi quality. The simple and flexible installation also enables mobile or fixed installation of the system. The outdoor unit is only connected to the indoor unit via a network cable, allowing you to bridge distances of up to 80m.

Dims. outdoor unit: (W/H/D) 320 x 155 x 65 mm.

Indoor unit dims. (W/H/D): 131 x 79 x 18 mm.

Scope of delivery WiFi 2.4/5.8 GHz outdoor antenna w/ router, RJ45 connection cable for antenna & router (7.5 m), mounting bracket, router incl. antenna and 230/12 V power supply unit, 12 V car connection cable, operating instr.

49151

199,-

**MEGASAT**  
Brilliantes Fernsehen



## HD Stick 310 V3

- Razor sharp with Full HD resolution
- Picture formats: 4:3, 16:9
- 2 USB ports
- Hidden mounting behind the TV

HD satellite receiver (DVB-S2) suitable for concealed installation behind the TV. Infrared sensor with integrated display. Reception of all free HD programs. Incl. 2 USB ports for media playback. 7 days EPG.



496272

59,90

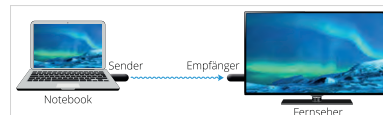

## HDMI Extender Mini II

- Wireless transmission of HDMI signals in Full HD (up to 30 meters) e.g. from notebook to TV
- Transmitter supports up to two receivers
- Perfect solution for meetings, conferences & home entertainment

Resolution up to 1080 pixels. Expandable with a second receiver (1 to 2).

Scope of delivery 1x transmitter, 1x receiver, 2x USB to micro-USB cable (length: 100 cm), 2x HDMI ext. (length: 17 cm), operating instr.

496271

150,-

**MEGASAT**  
Brilliantes Fernsehen



## SAT-Finder SF-200

Acoustic and visual signal display for aligning the satellite system. With integrated backlight, ideal for use in the dark. In addition, the Satfinder offers an attenuation control which can be used for optimum fine adjustment. 13-18 V DC supply voltage via the receiver.

492010

9,90

**MEGASAT**  
Brilliantes Fernsehen



## SAT-Finder SF-210

Digital signal display for aligning the satellite system. The integrated backlighting of the display also enables adjustment in the dark. The satellite finder's additional attenuation control allows for optimum fine adjustment. With the buzzer function, an acoustic signal sounds as soon as you approach a satellite.

492012

19,90

**KATHREIN**

## HDZ 66 Skew inclinometer



Installation set for flat antenna BAS 66/BAS 66 Skew. Simple alignment of antenna in conjunction with HDS 66 HDTV receiver (only w/ HDZ 66). Assembly in a few simple steps.

492927

99,-



## HDS 66 display + control unit

- Compatible with any receiver or TV set with integrated tuner
- Only suitable in conjunction with the HDZ 60 or HDZ 66 inclinometers
- Power supply via the receiver
- Two F sockets (IEC 169-24) as interface

49092

129,-

**MAXVIEW**  
HOME ENTERTAINMENT ON THE MOVE



## SAT finder

For quick and precise alignment of satellite antennas. The satellite finder is simply connected between receiver and satellite antenna. The approach to the satellite is indicated visually and acoustically by the LED display. The sensitivity control can be used to adjust the sensitivity to different reception levels.

49264

28,95



**KATHREIN**



**F-connection external socket outlet**

Outdoor socket outlet w/ F plug connection. 5 m coaxial cable. **49108 34,90**

**Outdoor sockets**

**F connection**

Outdoor socket outlet, 1x F plug socket incl. 3 m cable.  
Color white **49266 29,95**  
Color anthracite **492662 33,95**

**Twin F connection**

Twin outdoor socket outlet for operating 2 antennas. 2x F-plug-socket incl. 3 m cable. Color white **49763 36,95**

**F connection with coax socket**

Twin outdoor socket outlet for operating 2 receivers or as an indoor/outdoor socket outlet. 1 F plug and 1 coax socket incl. 3 m cable. Color white **49267 36,95**

**Coax socket**

Outdoor socket outlet w/ 1 coax socket incl. 3 m cable. Color white **49760 30,90**

**MAXVIEW**  
HOME ENTERTAINMENT ON THE MOVE



Fig. shows Twin F socket



**Satellite end socket**

W/ 3 connections, connection attenuation 1 dB, w/ surface-mounted housing. **492864 12,90**  
**492864L**



**12V aerial socket**

12 V cigarette lighter/TV/Sat, 1 pc. SB, slate (dark gray) or brown  
Slate **491102 14,90**  
**491102L**  
Brown **491100 15,90**  
**491100L**



**12V standard aerial socket**

12 V standard/TV/Sat, 1 pc SB  
Grey **49109 14,90**  
**49109L**  
Brown **491090 14,90**  
**491090L**



**Single and double frame for 12V socket**

**Single frame, 2 pieces**  
Grey **820751L 820751 2,50**  
Slate (dark gray) **820752L 820752 2,50**  
Brown **820750L 820750 2,50**  
**3Double frame, 1 piece**  
Grey **82074L 82074 2,95**  
Slate (dark gray) **820742L 820742 2,95**  
Brown **820740L 820740 2,95**

**Roof ducts**

① **Roof duct HDZ 100**

for holding a max. of 3 cables up to Ø 7 mm. Roof duct Ø 38 mm. Dims.: 211 x 90 x 37 mm **491922 29,90**

② **Cable entry box**

A maximum of 3 solar modules can be connected watertight in conjunction w/ connection cable (85071). Roof duct: Ø 28 mm, max. roof thickness 60 mm. **85072 27,95**



**Professional maritime cable ducts for camping vehicles and boats**

- Extremely high-quality maritime design (seawater-resistant)
- Split seal, therefore problem-free plug feed-through
- Protection class IP 68 (waterproof, dustproof)

**SCANSTRUT**  
outdoor technologies

	Wide Ø in mm	Opening max. Ø in mm	Height mm	Cable Ø in mm	Material	Item no.	Price
① DS-H6	30	N/A	17,0	2 - 6	Plastic	<b>85241</b>	<b>24,95</b>
② DS16	39	16	19,0	2 - 8	Kst. gray	<b>85140</b>	<b>29,95</b>
③ DS16	39	16	19,0	2 - 8	Kst. black.	<b>85257</b>	<b>29,95</b>
④ DS16	39	16	19,0	2 - 8	Stainless steel	<b>85160</b>	<b>56,95</b>
⑤ DS-H10	43	10	28	6 - 10	Kst. gray	<b>851405</b>	<b>34,95</b>
⑥ DS-H10	43	10	28	6 - 10	Kst. black.	<b>85258</b>	<b>34,95</b>



**CARBEST**



**Cable bushings**

Safe passage of cables through roof and wall. For gluing on with Sikaflex, incl. cable gland PG 13.5 for cable Ø of 6-12 mm.

- ① White, single (app. L13 x D9.8 x H5.8 cm) **85049 10,95**
- ② Black, single (app. L13 x D9.8 x H5.8 cm) **850493 10,95**
- ③ White, 2-fold (app. L12.4 x D9.3 x H3.8 cm) **850491 12,95**
- ④ Black, 2-fold (app. L12.4 x D9.3 x H3.8 cm) **850494 12,95**

**INDEX**  
MARINE

**REIMO**  
TOP PRICE  
**10,95**

**i** Further cable bushings in the electrical sector under Solar

	Wide Ø in mm	Opening max. Ø in mm	Height mm	Cable Ø in mm	Material	Item no.	Price
⑦ DG8P	35	10	12	2,5 - 6	Plastic	<b>85192</b>	<b>10,95</b>
⑧ DG21P	49	25	19	4,5 - 9	Plastic	<b>85194</b>	<b>22,95</b>
⑨ SE1P	app. 50 x 70	8	-	2 - 8	Plastic	<b>85200</b>	<b>15,95</b>
⑨ SE6P	app. 55 x 75	12	-	10 - 12	Plastic	<b>85201</b>	<b>21,95</b>
⑩ DK2	app. 63 x 82	6	-	2x3x6	Plastic	<b>85202</b>	<b>25,95</b>

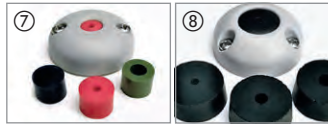

# ANTENNA MAST/SAT TRIPOD

**CARBEST** 



## Telescopic antenna mast for TV antennas

- Allows easy adjustment of the antenna without leaving the vehicle
- Suitable for motorhomes and caravans
- Reliably protected from water ingress
- Made from high-quality aluminum

### Antenna mast 50 cm

Total length: 50 cm, Ø 30 mm. Anodized and corrosion-resistant aluminium. Double O-ring-System reliably protects against water ingress  
Weight: app. 0.5 kg.

**492410 53,90**

**KATHREIN**



## Articulated satellite mast/conversion articulated mast

- High ease of use thanks to swivel & tilting option
- With two retracted connection cables & four F-plugs
- Poles made of aluminum, rod ends made of die-cast aluminum
- Max. Driving speed 130 km/h w/ antenna folded in

### ① HDM 140

• For mounting the BAS 60/66 flat antenna on the caravan or motorhome, length: 103 cm **49215 239,-**

### ② HDM 141

• Shortened version for mounting the BAS 60/66 flat antenna on caravan or motorhome, length: 76.5 cm **49216 239,-**

### ③ HDM 143

• For conversion from a terrestrial reception antenna, e.g. HD 35, to the BAS 60/66 Skew flat antenna  
• Roof lead-through bracket can still be used **49219 219,-**



Easy alignment thanks to integrated bubble level.

**MAXVIEW**  
HOME ENTERTAINMENT ON THE MOVE



## Universal SAT tripods and floor mounts

- Integrated "water trolley function"
- Correct alignment with the satellite
- Also with height-adjustable mast

### Maxview Sat tripod "Classic"

Sat tripod, ultra-light, long feet for a secure stand. The best reception location for satellite reception.

### ① "Classic" aluminum sat tripod

3-legged, ultra-light. Fastening with tent pegs.

For mirrors with universal pole mount up to 90 cm, telescopic 94 - 101 cm Pack size 81 x 13 cm. Weight 1.35 kg. Tube Ø 34 mm

**492400 64,70**

### ② Sat tripod "De Luxe"

as "Classic", but telescopic from 120 - 170 cm, tube Ø 34 mm, pack size 102 x 15 cm, weight 1.7 kg.

**492690 87,40**

### ③ Lawn spike (ground holder)

Attachment of antenna, umbrella or rotary dryer. Galvanized, length: 50 cm.

**90314 7,95**

BP\* = Base price per specified unit

## Outdoor sockets

### Multifunctional external socket outlet

With USB-A and USB-C input, 230 V, 2x antenna/TV, dimensions: 130x145 mm, Cover White (RAL 9010) **820405 95,95**



### Multifunctional outdoor socket outlet for 12 V / 230 V

2 x TV-Sat. Magnetic closure against unintentional opening. Dims.: 130 x 145 mm.

White	<b>820392</b>	<b>63,50</b>
Grey	<b>820393</b>	<b>63,50</b>
Light gray	<b>820394</b>	<b>63,50</b>
Black	<b>820395</b>	<b>63,50</b>

### Replacement lid

Black	<b>65232D</b>	<b>22,40</b>
Light grey	<b>65234D</b>	<b>22,40</b>
White	<b>65233D</b>	<b>22,40</b>
Grey	<b>65235D</b>	<b>22,40</b>

### external empty box deep

with closed rear panel, deep version, incl. foam rubber seal, without cover, gray **820303 20,-**



### Empty box

Empty box w/ closed rear panel & magnetic closure, dims.: 130 x 145 mm, gray **820382 24,60**



### Multifunctional external socket outlet

for 12 V / 230 V, antenna / TV Sat, dims.: 100 x 100 mm

<b>Silver gray</b>	<b>820171</b>	<b>29,-</b>
Spare lid gray	<b>820176</b>	<b>9,70</b>







**Window feed-through**  
Slim Line window passage-cable guide for satellite connection cable(F plug) is shielded.  
492859 6,30  
492859L



**F-angle plug**  
For kink-free bending of cables, 2 pieces SB.  
492611 2,95  
492611L



**F-IEC adapter**  
① Adapter F plug to IEC socket  
492875 2,95  
492875L  
② Adapter F socket to IEC socket  
492874 2,95  
492874L



**F-connector**  
For connecting two F plugs n, 1 piece SB.  
49265 2,90



**F-connector**  
For coaxial cable, 2 pieces  
Ø4,4 mm 492865 2,95  
492865L  
Ø5,0 mm 492866 2,95  
492866L  
Ø6,5 mm 492867 2,95  
Ø6,9 mm 49261 4,25  
492861L



**IEC right-angle plug**  
① Coaxial angle plug  
1 piece, white  
492621 1,80



② Coaxial angle bushing  
1 piece, white  
492631 1,80  
492631L



**Digital coaxial cable**  
Shielding rating >100 dB, inner conductor CU, 75 Ohm, jacket 7.3 mm PVC.  
100 m 492858 63,50



**IEC TV cable, 1.5 m**  
IEC plug to IEC coupling. Connection cable antenna socket to TV/radio.  
492872 3,95  
492872L



**Sat connection cable**  
10 m. With permanently mounted F plug on both sides.  
492860 11,95  
492860L



**MEGASAT**  
Brilliantes Fernsehen

**Flexible coaxial cable Flex**

1,5 m	492681	6,90
3 m	492682	7,90
5 m	492683	9,50
10 m	492684	13,90
20 m	492685	21,50

Cable with nickel-plated F-connectors, 75 Ohm, Ø 6 mm.



**Sealing tape**  
Self-welding, for sealing plugs, connections, soldered joints, etc.  
10 m 492856 15,95  
80 cm 492857 2,70



**Sealing grommet / gel sealing sleeve**  
For optimum weather protection at LNB connection.  
Sealing grommet for F plug, 1 pc.  
492880 1,50  
Cuff filled with flexible sealing gel. 1 pc.  
492876 5,50  
492876L





**Coaxial plug**  
DIN 45325, inner conductor clamped. BZT approval white, 1 piece SB  
49262 1,95



**HDMI cable**

Gold-plated plug	1,5 m	492870 5,95
		492870L
	3 m	492879 7,90
	5 m	494784 10,95
	7 m	494785 14,95
Angled plug	2 m	494783 14,95



**USB cable, 1.8 m**  
For connecting e.g. printers, cameras, receivers and much more.  
492871 2,95



**2-fold distributor**  
Also suitable for single-cable systems such as DPA 31 & DPA 51 as well as Unicable systems. 10 dB attenuation, DC pass-through (for SAT).  
492873 9,95



**Van View - Reversing infrared camera for panel van with split rear door**

Ideal for the vehicle roof edge, e.g. for panel vans and transporters with split rear door. Resolution: 500 x 582 pixels. 0 Lux, 9 night vision LEDs, viewing angle 120°, voltage: 12 Volt, temp. range: -20 to 70° C. Scope of delivery: Camera, 20 m connection cable, instructions & mounting material.

47803 119,-



E9

**Radio transmission for reversing syst.**

Reversing camera image can be transmitted wirelessly to a monitor via radio system. Installation is carried out without laying cables, thus reducing installation time. Operation via 12 V or 24 V possible. Radio range also suitable for larger motorhomes and caravans\*. Digital 2.4 GHz radio transmission.

**Scope of delivery:** 1 receiver, 1 transmitter, incl. adapter for Carbest reversing systems.

47439 99,95

\*Radio range max. 10 meters



①



②

NEW



③

NEW



NEW

④

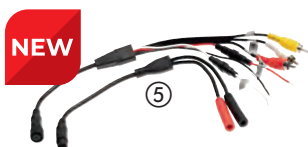

NEW

⑤



⑥

NEW



NEW

⑦



NEW

⑧

① **Rear view camera for Ford Transit**

Reversing camera for Ford Transit, 7. Transit generation, from 2014, camera replaces the 3rd. Brake light, CCD sensor, viewing angle (dia.): 140°, mechanically adjustable camera angle, integrated microphone, night vision IR LEDs, 3-part 10 m system cable (cinch) with screwed plugs

ZE-RCE3804 82212 199,-

② **ZE-RVC82MT –**

**Compact universal reversing camera**

Die-cast aluminum housing, CMOS sensor, viewing angle (dia.): 170°, camera head can be swiveled vertically, concealed cable routing and mounting, 10 m connection cable (RCA)

ZE-RVC82MT 815440 179,-

③ **Adapter for Camos prewiring**

(e.g. ADRIA & HYMER)

Z-EACC-CADIF 815442 36,-

④ **Double lens camera**

• Dometic adapter included

CMOS sensors, viewing angle (hor.). Cam1: 50°, Cam2: 95°, Cam2 with night vision IR-LEDs, integrated microphone, 3-part 17 m system cable (Cinch)

ZE-RVSC200-MK2 48190 399,-

⑤ **Adapter for CAMOS prewiring**

(e.g. ADRIA & HYMER)

N-ZERVSC200-CM 48311 29,-

⑥ **Brake light camera**

• directly compatible with ZENEC prewiring in LAIKA, LMC, HYMER, ETRUSCO campervans

ZE-RCE3701-MK2-S 48193 199,-

⑦ **Dual sensor brake light camera**

• Dual lens camera for Campervan Ducato III (fits Dometic CAM35 prewiring)

Camera console for brake light integration (not included) from Fiat Ducato, CMOS sensors, viewing angle (hor.) Cam1: 50°, Cam2: 100°, angle Cam2 mechanically adjustable, integrated micro, night vision IR LEDs, 11 m system cable, connection for Dometic CAM35 cable

ZE-RCE3704-2S 48305 349,-

Adapter for prewiring Camos

(e.g. ADRIA & HYMER) 815442 36,-

⑧ **Adapter for CAMOS prewiring**

(e.g. ADRIA Campervan)

N-ZERCE37042S-CM E12025 29,-

ZENEC monitor see page 872



## High-quality brake lights with integrated rear view camera

- High-resolution cameras
- Plug & Play installation
- Night mode with night vision IR LEDs (exc. 47813)
- 10m connection cable included
- All stop light cameras E9 certified



Connection cable included w/ all brake light cameras

E9



Model	① Fiat Ducato / Peugeot Boxer / Citroën Jumper and similar from YOC. 2006	② Volkswagen Crafter from YOC 2017	③ Volkswagen Transporter 6 from YOC 2016 with large tailgate
Camera system	1/3 CMOS	1/3 CMOS	1/3 CMOS
Resolution (HxV)	720x480 Pixel	960x576 Pixel	960x576 Pixel
TV system	PAL	PAL	PAL
Protection class	IP68	IP69	IP69
Viewpoint	160°	170°	170°
Horizontal resolution	600 TVL	700 TVL	700 TVL
IR LEDs	6 LEDs	9 LEDs	-
Power supply	DC 12V	DC 12V	DC 12V
Operating temperature	from -20°C to +70°C	from -30°C to +70°C	from -30°C to +70°C
Energy consumption	< 3 W	< 3 W	< 3 W
Built in lens	2,6 mm	2,8 mm	2,8 mm
Emark certified	E9	E9	E9
Connection cable, length	10 m	10 m	10 m
Housing dimensions	app. 26 x 5,5 cm	app. 53 x 17,5 cm	app. 33,5 x 2,5 cm
Item number	47800	47812	47813
Price	179,-	179,-	129,-



**Dynavision LITE series**

- Cameras in LITE series offer a viewing angle of 180°
- Switchable auxiliary lines

**Technical data LITE series:**

Res.: 720x480 pixels, picture mode: NTSC, CMOS sensor: 1/3 CMOS, lens FOV: Horizontal 180°, vertical 90°, IP 67 waterproof.

- |   |       |       |
|---|-------|-------|
| ① DVN CWHD 910 LITE, body   | 47434 | 169,- |
| ② DVN CWHD 920 LITE, Fiat Ducato  | 47436 | 169,- |
| ③ DVN CWHD 930 LITE, replacement brake light for ex works installed Hella light 2DA343106-207 | 47438 | 169,- |

**Dynavision PRO series**

- The PRO series cameras offer a rear-view mirror function with a viewing angle of 150° for permanent display
- Rear view camera (150°) with adjustable lines
- Wide-angle view with 180° viewing angle
- View from above for visual inspection when coupling a trailer
- The PRO series cameras can be controlled by touch via Dynavin radios. Other devices can be controlled by remote control.

**Technical data PRO series:**

Res.: 720x480 pixels, picture mode: AHD / NTSC, CMOS sensor: 1/4 CMOS. ARO140 from ON-Semi, ISP: GW4 from GEO-Semi, Lens FOV: Horizontal 210°, Vertical 140°, IP 67 waterproof.

- |  |       |       |
|--|-------|-------|
| ① DVN CWHD 910 PRO, body   | 47435 | 359,- |
| ② DVN CWHD 920 PRO, Fiat Ducato  | 47437 | 359,- |
| ③ DVN CWHD 930 PRO, replacement brake light for ex works installed Hella light 2DA343106-207 | 47459 | 359,- |



180° reversing function (LITE series)



Wide-angle view 180° (PRO series)



Reverse function 150° (PRO series)



View from above (PRO series)



**Adapter cable for connecting Dynavin cameras to pre-routed camera cables of different Motorhome brands**

- |   |       |      |
|---|-------|------|
| ① <b>Adapter cable Forster</b><br>Camera adapter for e.g. Forster Ducato w/ BNC and cinch connection  | 47460 | 30,- |
| ② <b>Adapter cable Sunlight / Carado</b><br>Camera adapter for e.g. Sunlight and Carado   | 47461 | 30,- |
| ③ <b>Zenec adapter cable</b><br>Dynavision Lite camera adapter e.g. for connection to Zenec cable   | 47462 | 30,- |
| ④ <b>Adapter cable Hymer / Bürstner</b><br>Dynavision Waeco camera adapter for e.g. Hymer Group / Bürstner  | 47463 | 30,- |
| ⑤ <b>Adapter cable Pössl, Hobby</b><br>Dynavision Dometic camera adapter for e.g. Pössl   | 47464 | 30,- |
| ⑥ <b>Adapter cable Knaus, Weinsberg</b><br>Camera adapter for e.g. Knaus models   | 47465 | 30,- |
| ⑦ <b>Adapter cable China</b><br>Camera adapter for cables w/ China connection   | 47466 | 30,- |
| ⑧ <b>Chausson / Challenger adapter cable</b><br>Camera adapter for e.g. Chausson & Challenger   | 47467 | 30,- |
| ⑨ <b>Adapter cable Adria / Camos cable</b><br>Camera adapter for e.g. Adria & Camos cable   | 47468 | 30,- |
| ⑩ <b>Laika adapter cable</b><br>Camera adapter for e.g. Laika models  | 47469 | 30,- |
| ⑪ <b>Adapter cable for reversing camera switching relay</b><br>Adapter makes it possible to connect 2 cameras at the same time. If reverse gear is engaged, the VIDEO OUT connection has the Signal from the reversing camera (R-CAM IN). If the reverse gear is left, the signal is forwarded to the second camera (e.g. to the front camera or 2. Camera as a mirror function). | 47479 | 29,- |



**Blind spot camera system - incl. foldable monitor for Fiat Ducato, Peugeot Boxer & Citroën Jumper from YOC. 2006**

- The set consists of front camera, 2 side cameras (for mounting on exterior mirrors) and folding monitor (DVN 6901 MO)
- The adjacent lane on both sides & overtaking cars directly next to your own vehicle become visible
- Front wheel and road visible all around when maneuvering
- No image distortion thanks to Software correction
- Installation w/o. calibration (nevertheless installation by specialist workshop recommended)
- Rear view camera required (Cameras can be found on pages 868-874)
- Also suitable for Fiat Ducato 8 (from 09/2021)

**Technical data Front camera & side cameras:** Activation by setting blinker or engaging reverse gear. Res.: 720 x 480 pixels, Picture mode: NTSC, CMOS sensor: 1/4 CMOS AR0140 from ON-Semi, ISP: GW4 from GEO-Semi, Lens FOV: Horizontal 210°, Vertical 140°, IP67.

**DVN 6901 LITE**

(Fiat Ducato panel van, semi-integrated)

47819      749,-

**DVN 6901 LITE - V**

(Fiat Ducato fully integrated)

47822      749,-



Side cameras for 47819

Side cameras for 47822

**Folding monitor for Fiat Ducato center console**

- Rear-view mirror function while driving (if the camera makes this technically possible)
- Simple installation: The monitor is inserted into original Fiat Ducato center console
- Elegant solution that blends in perfectly with the original look of the vehicle
- The monitor is simply folded down when not in use
- For all Fiat Ducato models from 2006 onwards
- Also suitable for Fiat Ducato 8 (from 09/2021)\*

**DVN 6901 MO**

47815      299,-



\*Not suitable for 10" system Fiat

Use e.g. as a rear-view mirror-Function while driving.



Fits perfectly into the Fiat Ducato Center console.



Use in parallel with the navigation system.





**ZENEC**

**7"/17.8 cm universal monitor for camera systems**

- Very flat and attractive housing with easily adjustable, stable mounting base and clip-on sun visor
- 7"/17.8 cm TFT-LCD screen with 1024 x 600 pixel resolution
- High luminosity of 400 cd/m<sup>2</sup> and optimum contrast ratio of 500:1
- Connection and control of up to 3 independent camera systems, w/ power supply
- Multinorm video system with support for PAL and NTSC-based camera signals
- Automatic reversing camera function, controlled via reversing signal (Reverse)
- Cam trigger signal inputs
- Image mirroring function
- Ceiling mounting possible
- Distance guides can be displayed separately for each camera image
- Automatic LCD TFT display day/night brightness control via LDR light sensor element
- Camera microphone input w/ adjustable volume & playback via integrated loudspeaker
- Simple operation via direct selection buttons on front of monitor & via separate IR remote control
- Operating voltage 12 V / 24 V
- Dims. (W x H x D): 180 x 120 x 17 mm (monitor)
- Monitor base, sun visor, 2 m main wiring harness w/ plug-in system connection & IR remote control incl. in scope of delivery

Maneuvering and parking large, heavy vehicles not only requires experience, but also the necessary overview. With the high-quality 7"/17.8 cm TFT LCD universal monitor ZE-MRV70 from ZENEC, you can keep an eye on everything at all times. Three cameras can be connected to the monitor (Cinch, CVBS), e.g. reversing, side or front cameras (PAL/NTSC).

The ZE-MRV70 impresses with its high resolution (1024 x 600 pixels) and brilliant image reproduction. The monitor can be activated automatically, manually or by remote control. All three camera images can also be switched on automatically via different triggers thanks to the trigger inputs. Auxiliary lines can be displayed separately for each camera for better distance estimation. Thanks to built-in loudspeaker, ZE-MRV70 can play back audio signals from a camera with microphone (CH1) - with adjustable volume.

The monitor has a practical stand with adhesive pad and is therefore easy to mount. The large contact surface ensures a secure hold. The stand can also be screwed on, e.g. for suspended mounting. The monitor can be flexibly rotated and tilted.

**ZE-MRV70** **47826** **199,-**



**DOMETIC**



**Colorball rear view camera CAM 18 NAV**

With housing for flexible alignment, normal or mirror image function, sturdy aluminum housing, freely adjustable ball camera, microphone, LDR-controlled IR LEDs. Color: Black

**47373** **329,-**





**Furrion Vision S rear view camera  
incl. side cameras and 5" or 7" Vision S monitor**

- An display of up to four cameras
- Digital 2.4 GHz connection
- Up to 150m range
- Night vision mode and motion detection
- Incl. 2 side cameras

Up to four cameras can be displayed simultaneously on Lippert Vision S monitor. The camera is transmitted wirelessly up to 150 m via a digital 2.4 GHz connection. The night vision mode supports you in poorly lit parking situations. The reversing camera has motion detection and offers additional safety when parking.

The anti-glare 5" or 7" touchscreen monitor can be easily read from any angle. The 5" or 7" monitor can be conveniently attached to your windshield or stand.

**Scope of delivery:** Lippert Furrion Vision S 5" or 7" monitor, incl. rear view camera, 2x side cameras w/ LED warning light, suction cup for windshield and stand

Technical specifications: Vehicle type: Motorhomes, res. (pixels): 720x480px, Voltage in V: 8-30V

**Lippert Furrion Vision S with 5" monitor    47823            549,-**

**Lippert Furrion Vision S with 7" monitor    47824            649,-**



Side Camera with LED Marker Light



Vision S Monitor



Doorway/Rear Camera

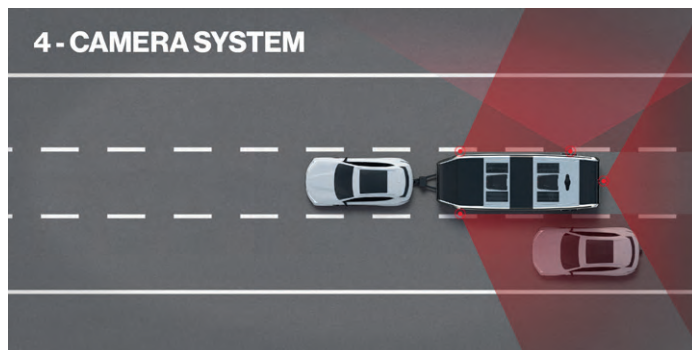

4 - CAMERA SYSTEM







**ADRIA**  
COMPATIBLE

①



## Assembly made easy

The special reversing cameras are designed for Adria vehicles that already have a Camos connection cable. Also especially for the Fiat Ducato X250. The reversing camera is mounted with minimal installation effort and connected to the existing Camos cable. Please order adapter cable for the existing Camos cable.

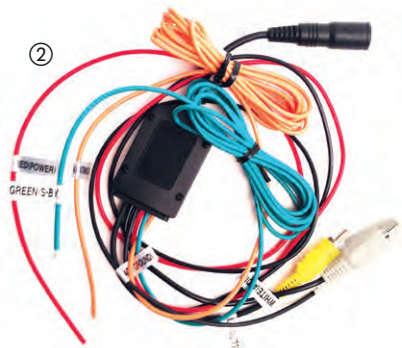

②

### ① Camos mini rear view camera CM-200M

1.3 megapixel, operating voltage 12-24V, heatable, w/ integrated microphone, waterproof (IP69K), viewing angle (H/V/D) 112/84/139, dims. incl. camera bracket (W x H x D) 51 x 46 x 54 mm

**473905** **199,-**

### Other adapters Camos and Dometic

#### ② Camos adapter DRN-033A

For connecting a Camos camera to an AV cinch connection (e.g. for built-in moniceivers/naviceivers).

**81731** **34,90**

#### Camos adapter DRN-031A (not shown)

For Adria from 2013, if cable available to AV cinch. (e.g. for built-in moniceivers/naviceivers).

**81730** **34,90**

**CAMOS**



## Complete reversing system SV-430

- Reversing system with CM-430 monitor and CM-36 camera
- Camera with infrared LEDs and microphone
- Integrated heating for a clear view

Reversing video system complete set with CM-430 monitor and CM-36 camera. The 4.3" monitor is compact and high-contrast with excellent picture quality. The digital display impresses with its high resolution and attractive design. Solid CM-36 color camera is equipped w/ infrared LEDs, a microphone & an integrated heater. The viewing angle of 125° makes maneuvering and reversing child's play.

**Features of the components:** Digital 4.3" TFT LCD display, high res. 480x272, all functions in display (OSD), 5 languages selectable (DE, EN, FR, IT, ES), dims. (H)140x (W)83x (D)20 mm, 16:9 aspect ratio/contrast 700:1, brightness 400ccd/1 video input. Color camera: 700 TV lines, wide viewing angle 125°, IR LEDs, heating, microphone, CCD technology, stainless steel sun visor.

**47358** **329,-**



**D9-DCX2022 Plus-C navigation system for Fiat Ducato 8 from YOC. 09/2021, Fiat Ducato / Citroën Jumper / Peugeot Boxer from YOC. 2006**

- Android 11 OS with 4 GB RAM and 320GB ROM
- High-quality 10.1"/16:9 LCD capacitive touchscreen display (resolution 1280 x 720)
- Compatible w/ Apple CarPlay, Wireless Apple CarPlay, Android Auto & SmartPhone Mirroring
- Google Play Store pre-installed. Connection to Internet via integrated WLAN module
- Integration of CANBUS solution for steering wheel operation
- BT for audio streaming and hands-free calls via any smartphone (Android, Apple, etc.). External microphone included
- FM-RDS tuner with DSP noise masking and 15 preset stations, integrated DAB. Supports automatic switching between DAB and FM (seamless blending)
- Integrated sound DSP processor with 16-band EQ and time correction.
- Multimedia player via USB port
- Reversing camera ready: Compatible w/ aftermarket reversing cameras.
- Integrated GPS navigation (3 years of free map updates) w/ 3D view, online TMC & TTS
- The D9-DCX2022 Plus-C is also compatible with Fiat Ducato, Citroën Jumper & Peugeot Boxer from 2006 onwards in combination with the 850380 mounting frame

**Technical data:**

Media playback (Audio: APE/FLAC/M4A/MP3/WMA/WAV. Video: MPEG-4/AVI/FLV/MPEG/MPG/DAT/VOB/MKV), SD card slot, 2 x USB port, AV input / AV output, Automatic station preset APS stores 5 stations with the best signal on page 3, Manual station preset for 15 stations.

Fiat Ducato 8 from 09/2021      850399      799,-

Mounting frame for installation in Fiat Ducato up to 08/2021, Citroën Jumper and Peugeot Boxer from 2006 onwards see optional acc. on this page.



10" Display

Installation instructions: This device only fits if no radio is fitted ex works was installed in the vehicle.

Also available with mounting frame for Fiat Ducato 2006-08/2021

Climate control panel not incl. in scope of delivery.



incl. remote control

Dynavin reversing cameras can be found on pg. 870.



**Dynaway navigation software included.**

Integrated GPS navigation (3 years of free map updates). Buy and download the latest map data from flex.dynavin.com. 3 or 7 years unlimited map data updates available on flex.dynavin.com. The latest map warranty provides a free map update in the same quarter as the first use of the Dynaway navigation software.

Scan the QR code and get all the technical data on this product. (www.dynavin.de)



**Optional accessories**

① **DVN-APTDC mounting adapter for Fiat Ducato 7**

Mounting frame incl. installation acc. for Fiat Ducato (2006-09/2021)      850380      19,-

② **DYN-DCLIN01 for Fiat Ducato 8 w/ telephone button**

Support of telephone button at steering wheel control on Fiat Ducato 8 (from 09/2021) by DVN-DCLINOT      850382      79,-

③ **D8-UFT02** & ④ **DVN-CABDC8**

Support for the vehicle settings of Fiat Ducato with factory radio

**D8-UFT02 (Fiat Ducato 2006-09/2021)** for Ducato 7 multifunction steering wheel      850389      109,-

**DVN-CABDC8 (Fiat Ducato 8 from 09/2021)** with original Fiat radio      850384      15,-

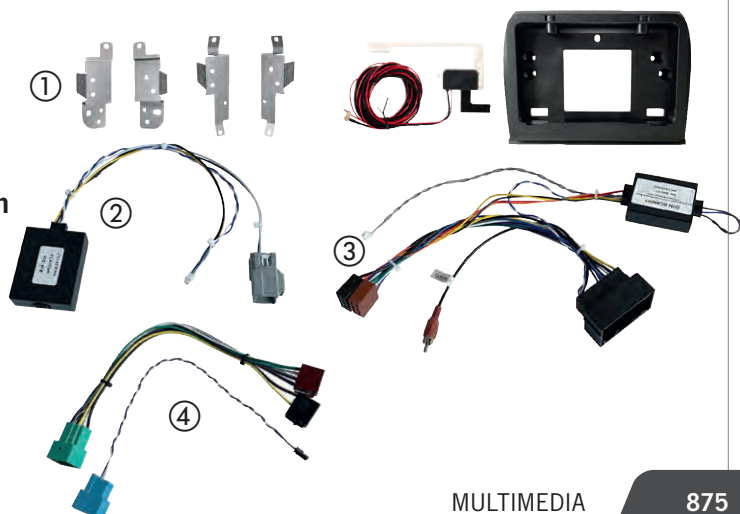



**XZENT**



**Naviceiver X-F275 - For Fiat Ducato III and identical models from YOC. 2006 / 2021\*\* / 2024\*\***

- Capacitive 8"/20.3 cm (X-F275) real glass touchscreen
- Apple CarPlay (via USB cable)
- AndroidLink for Android OS smartphones with dual-protocol support (via Autolink app)
- FM RDS tuner with DSP
- DAB+ twin tuner w/ dynamic station list, DAB-DAB service following, MOT slideshow, DLS text
- Bluetooth unit w/ hands-free function & A2DP music streaming, internal & external microphone
- Two USB 2.0 ports, 2 extension cables included in scope of delivery
- HDMI, 4 x 40 watt amplifier, Made for iPod / iPhone
- Control of up to two cameras w/ automatic switching function, superimposable guide lines, CAM direct selection button
- IR remote control, direct connection to steering wheel remote control, IR-IN for CAN/LFB interface
- 1 x cinch A/V input, 1 x cinch video output



XZENT's X-F275 infotainer is perfectly matched to FIAT Ducato III, Citroën Jumper II & Peugeot Boxer II - both visually & technically. The X-F275 has a large capacitive 8"/20.3 cm real glass touchscreen and masters the full infotainment program. In addition to analog FM tuner, it offers DAB+ with all convenience of a dynamic station list, DAB-DAB service following, MOT slideshow and DLS text. Two USB 2.0 ports take care of audio and video playback.

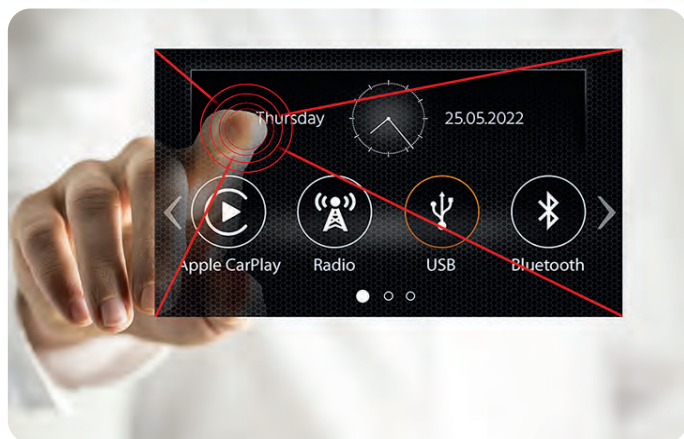

The X-F275 offers iPhone users Apple Car Play including Siri voice control, while owners of Android phones can look forward to the pre-installed AndroidLink app: it enables the screen content of Android smartphones to be mirrored on the infotainer display and then direct control of the mirrored apps via the touchscreen of the X-F275.

Two reversing cameras can be connected to the X-F275, and auxiliary lines can be displayed and set.

With the optional X-MAP27-MH1 or X-MAP27-MH3 navigation packages, the X-F275 infotainer becomes a comprehensively equipped naviceiver for motorhomes. Navigation software is not included in the scope of delivery of the X-F275.

<b>XZENT X-F275</b>	<b>850385</b>	<b>679,-</b>
---------------------	---------------	--------------

**\*\*Fitting installation frame for Fiat Ducato 8 from 09/21 and identical Stellantis models of series 2 from '24 N-XFDUC8**

<b>850379</b>	<b>29,90</b>
---------------	--------------

**Motorhome navigation software**

Upgrade your X-F275 infotainment system to a naviceiver: Software on 16 GB microSDHC card, coverage of 47 EU countries, realistic 3-D display, lane assistant, tunnel mode, auto-zoom Pre-configured and adjustable motorhome vehicle profiles with input of height, width, length, weight, trailer etc. Camping P.O.I. package with 20,000 points of interest & detailed information (multilingual: DE/EN/NL/IT/FR).

<b>X-MAP27-MH1, 1 year free map update</b>	<b>850308</b>	<b>199,-</b>
<b>X-MAP27-MH3, 3 years free map update</b>	<b>850306</b>	<b>249,-</b>

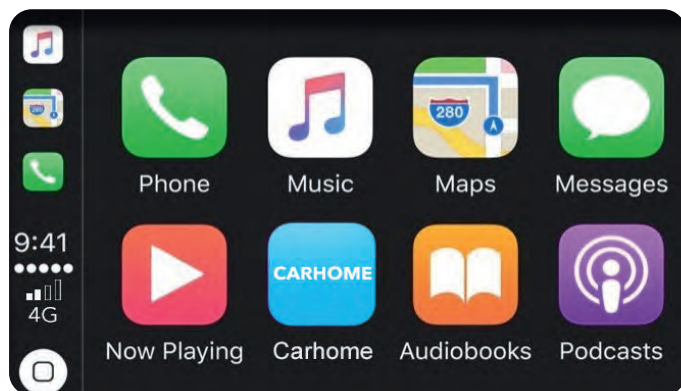



# XZENT

## X-107 & X-527 - Modern infotainment for your vehicle

- Capacitive 6.75" / 17.1 cm real glass touchscreen
- X-527: Apple CarPlay, Google Android Auto™
- X-107: WebLink® 2.0, w/ support for smartphone audio & video players, YouTube, Waze, Genius Maps from Mirai
- DAB+ tuner with DAB-DAB / DAB-FM Service Following and DLS text, X-527 additionally with MOT Slideshow and Comfort Scan
- FM RDS radio w/ FM World Tuner (all regions)
- Two USB 2.0 ports (X-527), one USB 2.0 port (X-107)
- Bluetooth unit with hands-free function & A2DP music streaming, internal & external hands-free microphone
- 4 x 45 watt amplifier
- Volume control, illumination Sensor control buttons: RGB multicolor (X-527), white (X-107)
- Control of a reversing camera w/ automatic reverse gear function, fade-in guide lines w/ X-527
- X-527: 1 x AUX Cinch A/V input, 1 x HDMI input, 2 x USB
- X-107: 1 x cinch A/V input, 1 x USB
- IR-IN for CAN/LFB interface

### 2-DIN INFOTAINER X-107

The X-107 with its capacitive 6.75"/17.1 cm real glass touchscreen fits into any motorhome w/ a 2-DIN slot & offers the latest entertainment functions. The clear front panel with four sensor buttons and a practical volume control knob shows that the X-107 is a truly convenient device. The X-107 is equipped with a DAB+ tuner and an FM world tuner, and via Bluetooth you can not only make calls but also stream music wirelessly from your smartphone. Thanks to the integrated WebLink 2.0 function, you can easily use various apps on your Android or iOS smartphone.

### 2-DIN INFOTAINER X-527

X-527 is a top-equipped 2-DIN infotainer w/ a 6.75"/17.1 cm real glass touchscreen, DAB+ tuner, FM world tuner, Bluetooth unit for hands-free calling & music streaming, two USB ports, a camera-in & an HDMI input. You can connect your smartphone directly to media center via USB - X-527 then supports Apple CarPlay & Google Android Auto™. Make calls, navigate, send & receive messages or simply listen to music & podcasts - you can conveniently control all functions using Siri, the Google voice assistant or via media center display.



from 239,-



XZENT X-107	850395	239,-
XZENT X-527	850396	399,-

## Installation panels

### 1-DIN for installation of 1-DIN devices in 2-DIN slot, incl. storage compartment

For Fiat Ducato, Peugeot Boxer, Citroën Jumper (from 2006 to 09/2021)	<b>815327</b>	<b>29,95</b>
For Ducato 8 (from 09/2021), Citroën Jumper from 08/2024 and Peugeot Boxer from 08/2024	<b>81609</b>	<b>32,75</b>
For MB Sprinter, VW Crafter (until 2018)	<b>815329</b>	<b>29,95</b>

### 2-DIN for the installation of 2-DIN devices in a 2 DIN slot

For Fiat Ducato, Peugeot Boxer, Citroën Jumper (from 2006 to 09/2021)	<b>815322</b>	<b>24,95</b>
For Ducato 8 (from 09/2021)	<b>81608</b>	<b>29,90</b>
For MB Sprinter, VW Crafter (until 2018)	<b>815323</b>	<b>24,95</b>
VW T5 startline/transporter (until 2015)	<b>815325</b>	<b>28,95</b>



## Fiat Ducato HQ fascia

- High quality for Fiat Ducato from 2006
- Fits perfectly with the interior design
- Installation kit included

Perfectly matched to interior of Fiat Ducato & identical models from 2006 onwards. For the installation of 2-DIN devices for vehicles with radio preparation.

High gloss black	<b>81567</b>	<b>45,50</b>
Black matt (not shown)	<b>81563</b>	<b>54,95</b>



## Installation frame for X-F275 for Fiat Ducato 8 from 09/'21 & Citroën Jumper / Peugeot Boxer from 08/'24

Radio mounting bracket for the installation of an XZENT X-F275 device in Fiat Ducato III, Series 8 based vehicles. 4x M5x6 countersunk screws for fixing the device. Front panel with side mounting plates made of ABS plastic. For Fiat Ducato 8 from 09/2021 w/ radio preparation.

**Notes on installation and function:** The original holder of the radio preparation is replaced by the N-XFDUC8 frame. It is attached using the four original screws, ensuring quick and easy installation. The metal mounting frame supplied w/ X-F275 is not required for installation in Ducato 8. Depending on vehicle body manufacturer, additional antenna adapters, FM/DAB switches or ISO cable sets w/ radio switches may be required.

<b>N-XFDUC8 for installation in Fiat Ducato 8 from 09/'21, Citroën Jumper from 08/'24 &amp; Peugeot Boxer from 08/'24</b>	<b>850379</b>	<b>29,90</b>
---	---------------	--------------



**Garmin Vioo - Infotainment for recreational vehicles  
Suitable for Fiat Ducato and Mercedes-Benz Sprinter**

- Detachable 10" control panel
- Garmin navigation w/ voice control for motorhomes
- 4 camera inputs for connecting compatible cameras
- Map & software updates via WiFi connectivity

The Vioo™ radio/dock is the basis for the fully integrated infotainment system and therefore the first step for installation in the motorhome. It enables many applications on one system, provides power for charging the control panel when docked and is compatible with the detachable 10" control panel. The removable control panels can be used as a remote control inside and outside the motorhome. Operation is also possible via the free FUSION-Link™ app for smartphones. The system offers full Fusion® media integration for multi-zone volume control. Specific navigation offers voice control, warning functions & special destinations for your motorhome vacation. Integrated safety features, including fatigue warning, advanced driver assistance features (requires front camera and custom configuration for installation) and more.

**Vioo RV 52 radio/dock**

Required as a base station for a control panel.

Dimensions: 17.6x7.12x13.5 cm **850370** **749,-**

**10" Vioo RV 1052 control panel**

10" screen diagonal (21.6x13.5 cm), resolution 1280x800 pixels. Integrated, rechargeable lithium-ion battery. Dims.: 24.5x15.4x1.7 cm, scope of delivery incl. USB cable & instructions.

**850372** **849,-**



Radio/dock



10" control panel

**Accessories for Garmin Vioo**

**Mounting kit for Fiat Ducato & Citroën** (not shown)

Compatible w/ Fiat Ducato YOC. 2006 - 2021. Includes external hands-free microphone, cover, holder, cable set & adapter for steering wheel remote control. For Ducato, Citroën Jumper and Peugeot Boxer from 2006 to 07/24

**850374** **149,-**

For Ducato 8 from 09/2021, Peugeot Boxer and Citroën Jumper from 08/24

**850376** **149,-**

**Mounting kit for Mercedes Sprinter** Contains external hands-free microphone, cover, holder & cable set. MB Sprinter from YOC. 03/2018

**850373** **149,-**

MB Sprinter W906 up to model year. 03/2018

**850386** **199,-**

**Add. charging station for 8" & 10" control panel** (not shown)

For surface-mounted installation, e.g. in vehicle living area.

**850375** **129,-**

**USB socket, for installation in glove compartment** (not shown)

**815083** **34,95**



MB Sprinter mounting kit



Connection cable set is incl. in installation kits





## Kenwood DNR992RVS Navitainer with 10.1 inch HD display with Garmin map data for motorhomes, digital radio DAB+ & smartphone connection

- 25.7 cm (10.1") HD display w/ "OPTICAL BONDING" technology
- Integrated Garmin navigation system especially for motorhomes, trucks and cars
- 3 years from activation free map updates
- Anti-reflective and anti-glare screen surface - readable from any viewing angle
- HD camera input for front/rear view camera
- Rear-view camera can be permanently activated as a rear-view mirror

The Kenwood Navitainer DNR992RVS for motorhomes: Garmin navigation, Wireless CarPlay & Android Auto or Android Wireless Mirroring, DAB+ digital radio, Wireless Hi-Res Audio, parametric equalizer, four camera inputs & much more. If you opt for the Navitainer DNR992RVS, you are already on the right track. Integrated Garmin navigation, w/ pre-installed POI database from Campercontact, is specially tailored to requirements of motorhome drivers. Thanks to its sophisticated anti-reflective coating, the pioneering and responsive 25.7 cm (10.1") HD touch display shows the most beautiful routes & videos w/ high contrast & impressive brilliance - even in bright sunlight. The extensive features for audio, video & radio playback, flexible smartphone integration, four camera inputs & much more make the DNR992RVS the ideal companion.

850393 1599,-



## Kenwood DMX8021DAB-CAMPER moniceiver w/ 7-inch display, SYGIC motorhome software & wireless smartphone connectivity (CarPlay, Android Auto)

- Integrated Sygic navigation software especially for motorhomes
- 17.7 cm (7") high-resolution WVGA double DIN monitor
- Capacitive high-gloss touch panel
- With anti-reflective & anti-glare screen surface
- Clear user interface w/ menu displays in 22 languages
- Adjustable viewing angle for ideal readability
- Freely selectable widgets on the home screen
- Low installation depth of only 85 mm
- Wireless Apple CarPlay & Android Auto for smartphones
- Bluetooth hands-free kit
- USB TYP-C port with fast charging function
- 4 camera inputs
- 3 years from activation free map updates

Capacitive touch display installed in new DMX8021DABS moniceiver has an anti-glare coating that makes surface noticeably anti-reflective without any loss of clarity or contrast. This means that the screen is easy to read even in direct sunlight. Together with the anti-reflective coating, the new display ensures outstanding image quality and readability.

850394 749,-

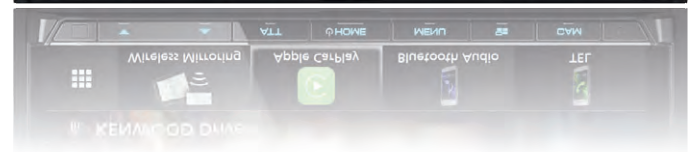

## Kenwood CMOS-740HD front and rear view camera

- Wide-angle lens: 180° horizontal / 103° vertical
- Picture in true 1280 x 720 (720P) HD res.
- High light sensitivity Color rendering
- Water-protected housing (IP67)

The CMOS-740HD camera can be connected to the front or rear camera input of the DNR992RVS (Item No. 850393) and displays the image in true 1280 x 720 (720P) HD resolution. High Dynamic Range (HDR) technology used by camera also helps to eliminate image distortions caused by particularly dark or bright lighting conditions, making it the ideal front/rear camera option. 12/24V voltage.

47825 219,-





**AVIC-Z1000DAB-C**

**9" MEDIA CENTER WITH MOTORHOME NAVIGATION**

- 9" navigation/media center with Wifi, Apple CarPlay™, Android Auto™ and DAB
- Capacitive 9" WVGA touch panel, 800 x 480 pixels
- 2x USB interfaces (rear)
- Connection of compatible smartphones - also wireless, depending on function & smartphone type
- Rear view camera connection, automatic switching, parking guidance lines
- Connection for second camera
- 44 European countries pre-installed in internal 16 GB memory
- 3 years free map update

All-in-one 9" motorhome navigation w/ 9" touchscreen (22.8 cm), rotary control for volume & on/off, quick selection button for reversing camera, DAB+, FM, Bluetooth® (hands-free calling, 2 telephones, audio streaming). Apple CarPlay™ and Android Auto™ via USB or wirelessly. 4 x 50 W, 2 USB inputs, 2 camera inputs, A/V inputs & outputs, graphic 13-band equalizer & much more.

Pre-installed European navigation, detailed information on over 20,000 pitches/campsites from ProMobil portfolio.

Input of vehicle data for route calculation (height, width, length, weight, number of axles). Including 3 years of free map updates.

<b>For Fiat Ducato 8 from 09/2021*</b>	<b>815692</b>	<b>1449,-</b>
<b>For Fiat Ducato up to 08/2021, Citroën Jumper and Peugeot Boxer from '06 to 07/24</b>	<b>815690</b>	<b>1449,-</b>



**SPH-EVO950DAB**

**9" SMARTPHONE RADIO WITH WI-FI®, ANDROID AUTO™, APPLE CARPLAY™**

- Capacitive 9" Touch panel
- 2 connections for cameras

9" touchscreen (22.8 cm), quick selection button for reversing camera, DAB+, FM, Bluetooth® (hands-free calling & audio streaming). Apple CarPlay™ and Android Auto™ via USB or wirelessly. 4 x 50 W, USB input, 2 camera inputs, A/V inputs & outputs, graphic 13-band equalizer & much more.

**MOTORHOME NAVIGATION APP SYGIC INCLUDED:**

3 years free of charge for 5 family members, European motorhome navigation, input of vehicle data for route calculation (height, width, length, weight, number of axles). ProMobil database w/ information on 20,000 parking spaces, operation on screen via Apple CarPlay, Android Auto or WebLink 2.0. Online information (with traffic information and assistance functions). Storage of the map material on the smartphone, therefore also fully usable offline.

<b>For Fiat Ducato 8 from 09/2021*</b>	<b>815694</b>	<b>949,-</b>
<b>For Fiat Ducato until 08/2021, Citroën Jumper &amp; Peugeot Boxer from 2006 until 07/2024</b>	<b>815695</b>	<b>949,-</b>
<b>For Ford Transit Custom from 2018</b>	<b>815696</b>	<b>949,-</b>
<b>For Mercedes-Benz Sprinter, suitable for W906 06-17, W907/910 from 2018</b>	<b>815698</b>	<b>949,-</b>



**SPH-EVO107DAB - 10.1" moniceiver with WI-FI®, ANDROID AUTO™, APPLE CARPLAY™ and more**

- Capacitive 10.1" Touch panel
- 2 connections for cameras

10.1" touchscreen (26.6 cm), quick sel. button for reversing cam., DAB+, FM, Bluetooth® (hands-free calling & audio streaming). Apple CarPlay™ and Android Auto™ via USB or wirelessly. 4 x 50 W, USB input, HDMI input, 2 camera inputs (camera connections HD-TVI compatible), A/V inputs and outputs, graphic 13-band equalizer and much more.

Luminous Bar: The LED strip shows the direction and distance of the next turn, regardless of the selected screen source

Scope of delivery: External GPS antenna and microphone are included.

<b>For Fiat Ducato 8 from 09/2021*</b>	<b>815680</b>	<b>1249,-</b>
<b>For Fiat Ducato until 08/2021, Citroën Jumper &amp; Peugeot Boxer from 08/2006 until 07/2024</b>	<b>815681</b>	<b>1249,-</b>
<b>For Ford Transit from 2008</b>	<b>815682</b>	<b>1249,-</b>

\*Citroën Jumper from 08/2024 & Peugeot Boxer from 08/2024



**Pioneer SPH-DA160DAB 2-DIN Moniceiver**

- Capacitive 6.8" touch panel
- 800x480 pixels
- Camera connection plus additional A/V input
- Display of parking aid lines
- Bluetooth hands-free parallel operation of two phones

6.8" capacitive touchscreen (17.3 cm), Bluetooth with hands-free calling and audio streaming, DAB+, FM, 4 x 50 W, 13-band graphic equalizer, camera input and much more. Only 125 mm deep short chassis for easy installation. Connection of compatible smartphones possible via Apple CarPlay™ & Android Auto™, USB mirroring for Android, capacitive 6.8" touch panel, 800x480 pixels, adjustable button illumination, background image customizable, USB interface (rear, extension included), playback of HD videos, NTFS-compatible, A/V inputs/outputs, camera connection plus additional A/V input, display of parking aid lines, 4x27W DIN sine, 3 pairs of cinch preamp outputs, adjustable subwoofer crossover, adjustable high-pass filter, input for car-specific steering wheel remote control (adapter optional accessory). Scope of delivery: Pioneer SPH-DA160DAB 2-DIN moniceiver, incl. conn. cable, external microphone & mounting acc.

494039 449,-



**Avtex/Garmin TOURER THREE Intelligent satellite navigation**

- 6.95" (17.7 cm) capacitive HD display
- Sat Navigation GPS improved for caravans and motorhomes
- Official location data of the Caravan and Motorhome Club
- Free Live traffic and map updates
- Exclusive database of European campsites
- Hands-free calling including Bluetooth calls
- Reach your destination and avoid roads with height, width and weight restrictions
- New routes for low emission zones
- Mith BirdsEye satellite images that show you where you must
- Information on road restrictions & elevation profile
- Adjustable profiles for caravans & motorhomes

The Avtex/Garmin Tourer Three makes navigation easier for caravans and motorhomes. Simply enter your vehicle data and the Tourer calculates the best route through Europe.

You get exclusive access to the Caravan and Motorhome Club's campsite database and other databases such as ACSI and Camper Contact with ratings. The Tourer suggests interesting places along the route and offers high-resolution satellite images of the destination for easier orientation. Dims. (W x H x D): 173 x 99 x 19 mm. Weight: 240 g

**Scope of delivery** navigation device, suction cup mount for windshield, car connection cable w/ 12V plug, quick start guide.

850391 449,-



**PIONEER DEH-S720DAB with integrated digital radio receiver**

- MP3/WMA playable
- Integrated digital radio receiver
- Adjustable RGB lighting
- iPod direct control via USB
- Remote control via Android app

Menu German/English/French/Russian/Turkish, RDS, FM/MW/LW, 24 station memory, CD drive, MP3/WMA playable, 1.5A Quick-Charge USB (incl. FLAC playback), iPod control via USB, AUX-In on the front panel, MOSFET 50: 4 x 50 W max, 4 x 22 W DIN sine, 3 pairs of high-voltage preamp outputs, 3-way active crossover, delay time correction, 13-band equalizer, Advanced Sound Retriever (ASR), optional adapter, volume control knob, ISO connection cable, removable front panel, backup memory.

494040 169,-

**DAB+ antenna for Pioneer DEH-S720DAB**

- For digital DAB+ reception
- Thousands of stations in best sound quality

DAB+ reception opens up world of digital radio to you with thousands of stations and crystal-clear, digital sound quality. This antenna is compatible with Pioneer DAB-capable CD/DVD tuners and corresponding media centers.

494066 34,95



# ADAPTER FOR CAR RADIOS AND DAB+/GPS ANTENNAS

For the best reception of FM/DAB+ and GPS in vans or motorhomes

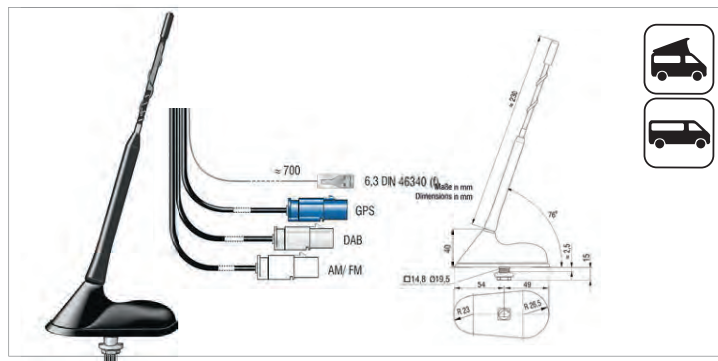

## 12V roof antenna for panel van with metal roof

- VHF/DAB+/GPS and GLONASS reception
- Active, small and powerful
- 3x Fakra plug for connection to almost all end devices
- Including 7.5 m connection cable

Especially for panel vans with metal roofs, e.g. Fiat Ducato, where antenna is mounted directly on metal roof. Cables are fed directly into the vehicle through a central drill hole (Ø 20mm).

**Scope of delivery:** rod antenna (height 23 cm), VHF, DAB+, GPS & GLONASS cable & adapter set to DIN, ISO, FAKRA, SMB, GT5, GT16 (length 7.5 m).

49170 229,-

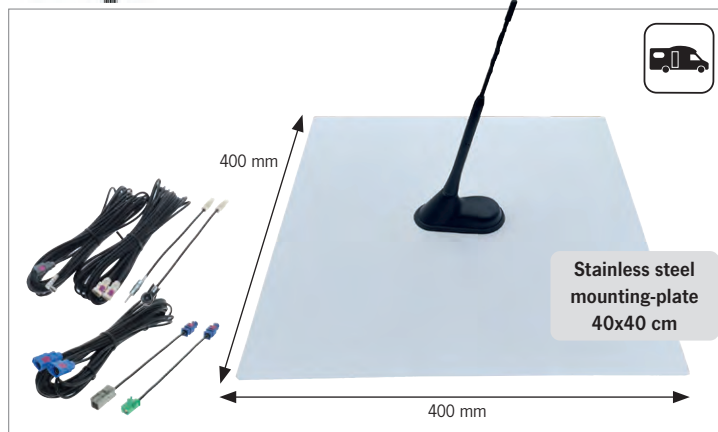

## 12V roof antenna for motorhomes w/ GRP roof

- VHF/DAB+/GPS and GLONASS reception
- 3x Fakra plug for connection to almost all end devices
- Including 7.5 m connection cable

Antenna with stainless steel mounting plate powder-coated in RAL 9003 (white, size 40x40 cm) – specially developed for vehicles w/ GRP roofs. The stainless steel plate amplifies the received signal and is affixed to the vehicle roof. (Manufacturer's recommendation: Dekalin adhesive set SetMS5, item no.: color white 500305). Cables are fed directly into vehicle through a central drill hole (Ø 20mm) under mounting plate. Gain: FM 14dB, DAB+ 10 dB, GPS/GLONASS 28 dB.

**Scope of delivery:** rod antenna w/ stainless steel mounting plate, VHF, DAB+, GPS & GLONASS cable & adapter set to DIN, ISO, FAKRA, SMB, GT5, GT16 (length 7.5 m).

49175 279,-

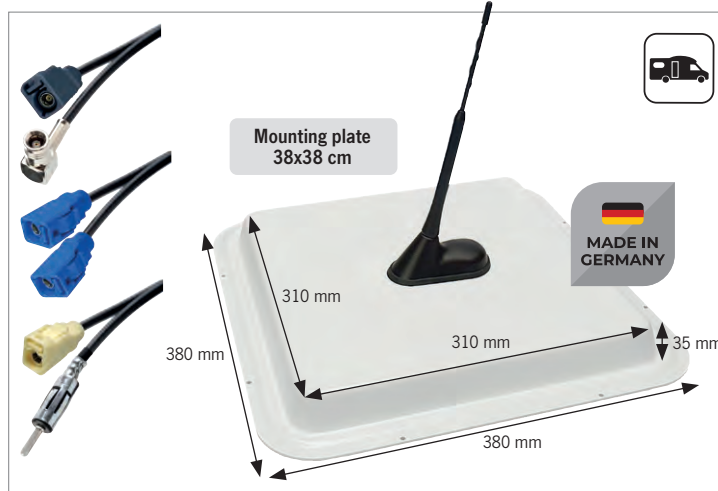

## Active 12V combiflex roof antenna for motorhomes w/ GRP roof

- FM/DAB+/GPS Glonass reception
- Plastic housing with integrated aluminum plate
- Enables flexible cable entry into roof thanks to extended connection cables (50 cm) at antenna base
- Can be screwed and / or glued together
- 12 V power supply for the FM / DAB amplifier either via internal conductor or external cable connection with DIN plug-in sleeve

**Scope of delivery:** Roof antenna (height of antenna rod: 23 cm), mounting plate, 6.5 m FM (DIN), DAB+ (SMB), GNSS (FAKRA) connection cable, dust protection seal, thread extension w/ nut.

49172 449,-

## GPS connection adapter

Xcent	815313	9,95
Pioneer	815314	14,95

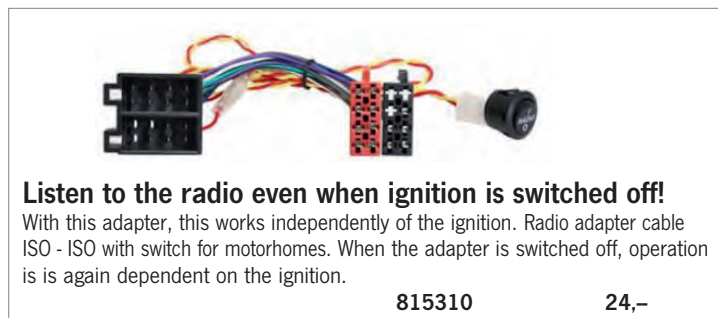

## Listen to the radio even when ignition is switched off!

With this adapter, this works independently of the ignition. Radio adapter cable ISO - ISO with switch for motorhomes. When the adapter is switched off, operation is again dependent on the ignition.

815310 24,-

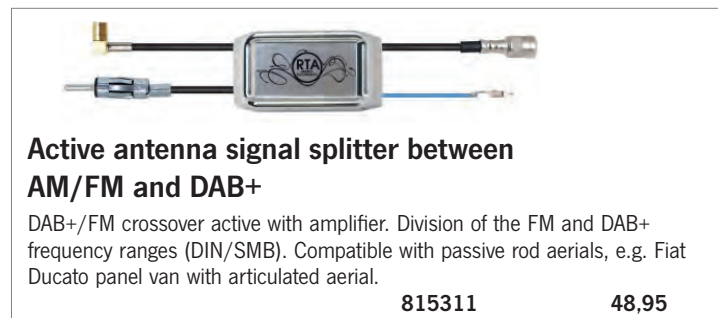

## Active antenna signal splitter between AM/FM and DAB+

DAB+/FM crossover active with amplifier. Division of the FM and DAB+ frequency ranges (DIN/SMB). Compatible with passive rod aerials, e.g. Fiat Ducato panel van with articulated aerial.

815311 48,95

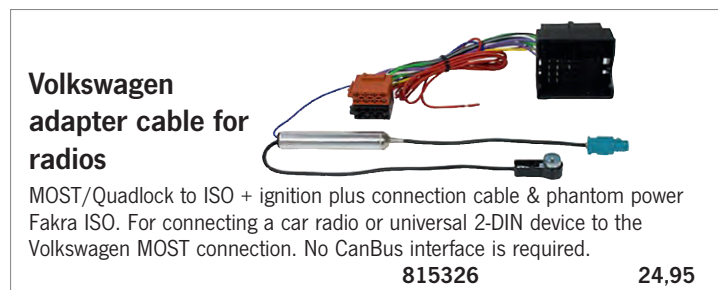

## Volkswagen adapter cable for radios

MOST/Quadlock to ISO + ignition plus connection cable & phantom power Fakra ISO. For connecting a car radio or universal 2-DIN device to the Volkswagen MOST connection. No CanBus interface is required.

815326 24,95

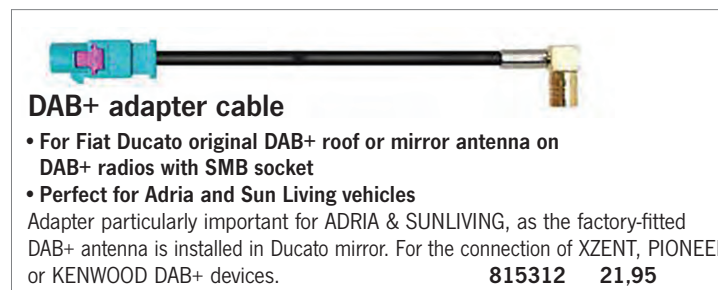

## DAB+ adapter cable

- For Fiat Ducato original DAB+ roof or mirror antenna on DAB+ radios with SMB socket
- Perfect for Adria and Sun Living vehicles

Adapter particularly important for ADRIA & SUNLIVING, as the factory-fitted DAB+ antenna is installed in Ducato mirror. For the connection of XZENT, PIONEER or KENWOOD DAB+ devices.

815312 21,95





Full-range and coaxial single speakers for excellent sound experiences on the move



① Low Installation depth



②

Mounting plate

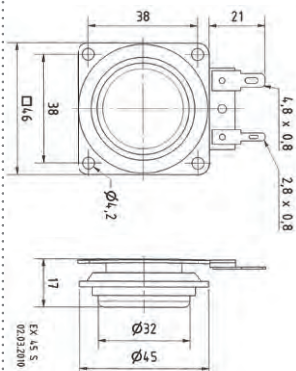
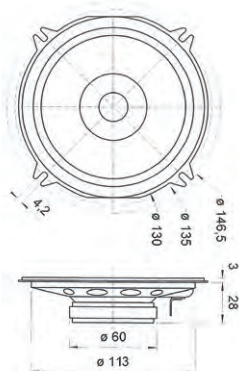

③



④

① **FR 12 The 28mm ultra-flat furniture loudspeaker**  
13 cm (5") full-range speaker with inverse surround. Particularly flat design (only 28 mm), so can be used wherever space is at a premium. (1 piece)  
**49811 21,70**

② **Exciter EX 60 S The individual flat-panel loudspeaker**  
Exciter, also known as a body sound transducer or body shaker. They can be attached to surface of the panel to be stimulated using adhesive or screws. Possible applications: Signal output in all kinds of applications where no visible loudspeakers can be installed for design reasons or to protect against environmental influences or vandalism (e.g. under the drop-down bed). Technical parameters depend on material, Dimensions and shape of panel to be stimulated.  
**49810 59,95**

③ **Accessories Protective grille for FR 12 (1 piece)**  
**49809 7,70**

④ **Loudspeaker cable (10m, 2x 0.75mm<sup>2</sup>)** **810629 11,10**

*Max. Long-term performance according to DIN EN 60268-5	FR 12	Exciter EX 60 S
Nominal/music load capacity	15 W / 40 W	25 W *
Impedance	4 Ω / 8 Ω	8 Ω
Transmission range (- 10 dB)	70–18000 Hz	
Average sound pressure level	85 dB (1 W/1 m)	
Limit deflection xmech	± 2.5 mm	
Resonant frequency	110 Hz	
Upper pole plate height	3 mm	
Voice coil diameter	20 mm	32,5 mm
Changing height	4,5 mm	
Baffle opening	114 mm	
Net weight	0,284 kg	0,12 kg



**Pioneer TS Fiat Ducato sound system: Practical complete package for sound enhancement**

- Suitable for Fiat Ducato, Peugeot Boxer & Citroën Jumper
- Adapter rings for precise mounting
- Practical Plug connections
- Illustrated installation instructions in German
- 16,5 cm 2-way Component loudspeaker
- Maximum load capacity 350 W, 80 W RMS

With tailor-made 2-way component speaker upgrade set from Pioneer, you can quickly & easily upgrade factory-fitted audio system of your Fiat Ducato X250/X290 (from 2006)\*. Practical, high-quality plug & play complete package, which is suitable for self-installation, is particularly easy to install\* thanks to installation & cable connection adapters supplied. The vehicle-specific installation instructions included in set will guide you safely through installation process.

**81708 174,--**

**Scope of delivery:**



\*Depending on vehicle, additional installation materials may be required.



Also suitable for  
Fiat Ducato 8  
(from 09/2021)

**2-way front system plug & play for Ducato & Sprinter**

- Guaranteed high quality & first-class listening pleasure in cab
- Installed in a few simple steps
- Pre-assembled for original installation locations and plug & play
- Can be expanded with an amplifier, 2-way system or subwoofer

Technical data: Power handling continuous/music: 2x70/140 watts; Frequency response: 49 - 22,000 Hz; Impedance: 4 Ω; Rec. Amplifier power from 2 x 40 - 80 watts at 4 Ω

**For Fiat Ducato, Peugeot Boxer & Citroën Jumper from 2006 onwards**

Speaker configuration: 2x 165 mm JEHNERT power woofer "XA165", 2x 19 mm neodymium soft dome tweeter "XA19Duc", 4x aluminum butyl mats  
**81737 199,-**

**For Mercedes Sprinter W907/W910** Speaker configuration: 2x 165 mm JEHNERT power woofer "XA165", 2x 19 mm neodymium soft dome tweeter "XA19", 1x center crossover  
**81738 249,-**

**For Volkswagen T6.1/T6**

Technical data: Power handling cont./music: 2x70/140 watts; Frequency response: 49 - 22,000 Hz; Impedance: 4 Ω; Empf. Amplifier power from 2 x 40 - 80 watts at 4 Ω

**Speaker configuration:**

2x 165 mm JEHNERT Power Woofer "XM165",  
2x 25 mm neodymium soft dome tweeter "XA25VW"  
JEHNERT crossovers, vehicle-specific calibrated

**For Volkswagen Transporter 6 81735 279,-**

**For Volkswagen Transporter 6.1 81736 279,-**



**Sound performance for the Fiat Ducato III and Series 8/9 - 3-way front system!**

- 2x 26 mm neodymium soft dome tweeter "XE26"
- 2x 80 mm midrange driver "XE 80"
- 2x 165 mm JEHNERT power woofer "XM165"
- 2 x MHT JEHNERT crossovers wrapped in damping fleece

In acoustic fine-tuning, the vehicle-specific 3-way sound system provides a rich low-frequency foundation and achieves a powerful, lively sound image. High-quality 26 mm soft-dome neodymium tweeters and 80 mm high-end mid-range speakers in the dashboard perfect the sound image with a very spatial and detailed sound stage. The vehicle-specific mounting adapter allows the integration of a 165mm JEHNERT Power Woofer in the factory installation openings of the vehicle doors. The GRP midrange/tweeter module for the dashboard is covered with high-quality artificial leather in black.



**Fiat Ducato 7 & identical models (2006 to 08/2021)**

**81757 549,-**

**Fiat Ducato 8 (from 09/2021)**

**81769 549,-**

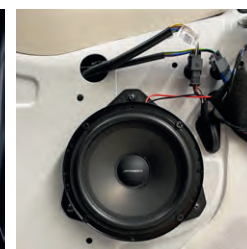

**Center switch for MB Sprinter W907/W910**

For harmonious integration of center speaker in Mercedes Sprinter sound system (for connection to factory loudspeaker system).

**81743 24,95**

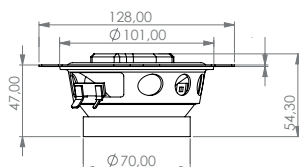

**High quality 2-way 100mm Coaxial system**

The 2-way rear system completes the living area with optimum surround sound. Two 100 mm coaxial loudspeakers ensure greatly improved basic sound reproduction. Incl. Mounting ring and cover grille.

**81756 69,90**

Technical data:	100mm midrange driver & 13mm neodymium tweeter
Load capacity (RMS)	60 watts
Maximum power	120 watts
Impedance	4 Ohm
Installation dims.	Ø 94 mm x D 48 mm



## AMP V40 CampTec 4-channel amplifier For Fiat Ducato, MB Sprinter and VW T6.1/T6

- For radio, TV, smartphone and tablet
- Radio connection: High-power input for automatic switch-on
- TV connection via AUX-In TV, jack input 0.1-5V adjustable
- BT connection via BT AUX-IN, jack input 0.1-5V adjustable
- 2x 3.5mm jack input - incl. 2m jack cable
- High-level / RCA input as well as cinch input w/ plug & play connections guaranteed to be latch-proof

compact and versatile amplifier that impresses with its new innovative technology, simple operation and intelligent switching of the desired music sources.

The 320 Watt/2 Ohm output enables the operation of a front and rear loudspeaker system or a front system with subwoofer. Thanks to innovative technology, the power amplifier can be operated directly via radio's power supply - without external power source.

**81739 120,-**

Note: an ISO cable must be ordered separately for connection to radio / head unit, as well as a radio adapter cable if necessary



### Technical data "AMP V40 CampTec"

#### 4-channel amplifier with 2x jack and 4x high/low level input

Operating voltage / fuse	10 - 16 V / 1x 15A
Output power at 14.4 V	4x 40/80 Watt - @ 4 Ohm
-RMS power @4/2 Ohm stereo	4x 60/120 Watt - @ 2 Ohm
High-pass filter (HPF) channel 1+2 continuously adjustable	from 50 to 4,000 Hz
High-pass filter (HPF) channel 3+4 continuously adjustable	from 50-4000 Hz
Low-pass filter (LPF) channel 3+4 continuously adjustable	from 80 -2,500 Hz
Dimensions (H x W x D) / Weight	45 x 162 x 80 mm / 400g

### Necessary accessories for AMP V40 amplifier:

#### ISO cable for amplifier incl. subwoofer interface (not shown)

for retrofit radio and connection to original radio (note: additional radio adapter required for original radio)

**81744 36,95**

#### Radio adapter cable (not shown)

For adapting the amplifier to the factory radio via ISO. Enables easy installation of plug & play amplifier on original wiring harness in vehicle.

**For Volkswagen Transporter 6.1/6 81745 44,90**

**For Fiat Ducato 8 from 09/2021 81746 35,-**

**For Mercedes Sprinter W907/W910 81747 46,90**  
for models without E3D interface

### Optional accessories for AMP V40 amplifier:

#### Bluetooth receiver 3.5 mm jack (not shown)

Establishes a wireless connection between smartphone & amplifier, without switching on radio/MBUX

**81753 49,90**

#### Interference suppression filter 3.5mm jack (not shown)

Removes and prevents noise from TV or radio, frequency: 2 - 20,000 Hz, connection via 3.5 mm jack. No power supply required.

**81749 21,90**

#### Jack cable 7.5m (not shown)

For connecting an amplifier or radio to the TV

**81754 8,-**

**Mounting bracket for Fiat Ducato, Peugeot Boxer, Citroën Jumper from 2006 onwards** Allows amplifier to be mounted behind glove compartment.

**81748 8,-**



## Bass reflex subwoofer - w/ 1x165mm dual voice coil incl. subwoofer cable

The task of a subwoofer is to support the low frequency range. JEHNERT bass reflex subwoofers in various sizes have been specially developed for recreational vehicles with limited space. Despite the small housing volume, they deliver maximum sound quality. All subwoofers have a "plug & play" connection cable

and are powered by the compact 4-channel amplifier to save energy. To connect the passive subwoofer, an amplifier (e.g. 81739) is required.

### Fiat Ducato, Peugeot Boxer & Citroën Jumper from 2006 onwards

Mounting below cup holder in center console. **Attention:** Only suitable for models with cup holder. Weight 4.5 kg

**81742 374,-**



### For Volkswagen T6.1/T6

Ideal for under the passenger seat. Weight: 4.84 kg

**81741 259,-**



### Mercedes Sprinter W907/W910

Ideal for seat console, passenger side or seating area.  
Dims. (LxWxH): 31 x 23.5 x 19.3 cm  
Weight 5.6 kg

**81755 309,-**



Technical data (item no. 81742, 81755, 81741)	Subwoofer
Output power at 14.4 V - RMS power @4/2 Ω stereo	1x 100 W sine wave / 200 W
Max. linear diaphragm stroke	+ / - 5,0mm
Efficiency 1W/1M/impedance	2x 2 Ω
Transmission range	32-180 Hz
Membrane material	Handmade paper membrane