





# HOME COMFORT

**CARBEST** 



**NEW**



## Window pockets for Ford Transit Custom & Tourneo Custom V710 >2023

- Attachment without screws
- Removable at any time
- Extra storage space
- Blackout function
- Robust, durable material

Side window pocket left and right. Provides more storage volume in the interior.

With two mesh outer pockets, carrying handle and blackout function.

Material: 100% polyester, load capacity: max. 5kg

### ① For Ford Transit Custom V710 >2023 (without interior trim)

Left side, approx. L 91 x H 49 x W 13cm **919183** 99,95

Right side, approx. L 91 x H 49 x W 13cm **919184** 99,95

### ② For Ford Tourneo Custom V710 >2023 (with interior paneling)

Left side, approx. L 81 x H 43 x W 14cm **919189** 99,95

Right side, approx. L 75 x H 43 x W 14cm **919190** 99,95

Universal mounts.....	534	Window pockets/Window panels.....	543
Cup holders/Cabin fans.....	535	Pockets for rear doors + interior.....	544
Storage compartments/Storage nets.....	536	Extra beds / Cribs / Toppers.....	544 – 547
Dashboard shelves/Sliding door storage.....	537	Bed kits/Sleeping systems.....	548 – 549
Cabin floor mats.....	538 – 540	Safety nets.....	550
Heating foil/Heating carpets.....	541	Retrofit lift beds.....	550 – 551
Organizers/Backrest cushions for cabin seats.....	542		

# UNIVERSAL MOUNTS



Horizontal & vertical use

360°

360°

## ① Universal navigation & smartphone holder

W/ suction cup attachment, 360° rotatable, material: ABS+PU, color black, dims.: 12x10x7.5cm. Weight 0,1kg

46238 7,95

## ② Universal tablet / smartphone holder

For tablets with a maximum width of approx. 10-17.7cm, 360° rotatable, for headrests, bicycles, tent poles, etc. For tubes with Ø 18-34mm. Material: aluminum and plastic. Weight 0,3kg

462381 22,95

## SCANSTRUT® Universal fasteners for free combination



Tablet holder  
493466

39,95

Smartphone holder  
493467

36,95

Action camera mount  
493468

22,95

1/4" camera mount  
493469

22,95



- Extremely stable and high quality brackets
- Simple locking with just one hand movement
- A wide range of mounting options
- Waterproof & corrosion resistant (stainless steel screws)
- Base with quick release



## ROKK™ | mini

Adjustable support arm  
493460 55,95



Retaining system for screwing  
493461

20,95



Holding system with suction cup  
493465

36,95

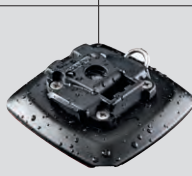

Self-adhesive holding system  
493464

25,95



Holding system round tubes (e.g. bike handlebars)  
493462

34,95



Holding system for thick round poles & masts  
493463

22,95



## X-Grip universal mobile holder w/ extra long arm



- Secure hold on windshield due to strong suction base
- Extra long holding arm for comfortable device operation
- X-shaped clamp securely fixes even large smartphones

The universal smartphone holder for the windshield with spring-loaded X-Grip holding clamp. The flexible holding clamp adjusts to the smartphone dimensions. The extra long arm enables comfortable device operation even from a greater distance. Scope of delivery: Suction cup, base, extra-long connection arm, X-Grip for large smartphones

462382 109,-





**CARBEST** 



**Can holder Ben**

For transporting open beverage cans or bottles. Mounting on vertical surfaces or simply hanging. Adjustable clamp system - collapsible.

Grey	<b>462190</b>	<b>4,95</b>
Black	<b>462210</b>	<b>4,95</b>

①



②



**CUP-IN Cupholder for Volkswagen T5/T6 & Mercedes-Benz V-class**

Stable thanks to ceramic-coated metal and polyamide. Optimal for containers with Ø 65 - 80mm and minimum height 95mm. Assembly without tools. Color titanium silver and matte black.

① **For wide armrests:** Not suitable for original armrests in Volkswagen utility vehicles > 5/2003. Dimensions: 88 x 164 x 96mm. Weight 220g.

1 piece	<b>46220</b>	<b>30,95</b>
---------	--------------	--------------

② **For narrow armrests:** with a minimum height of 45mm and a maximum width of 58mm. Ideal on armrests of VW T5/T6 seats or e.g. Mercedes Viano/V-class. Dimensions: 88 x 148 x 96mm. Weight 210g

1 piece	<b>46206</b>	<b>37,95</b>
---------	--------------	--------------



**Sun screen extension - for cars & motorhomes**

Vertical and horizontal extension possible. Material: plastic (ABS). Dimensions: W 11 x L 27 x D 1.5cm. Color: grey, weight: approx. 0.25kg

<b>462068</b>	<b>29,95</b>
---------------	--------------

High-quality fans for a fresh breeze on the road in your motorhome or caravan.

**SEEKR**   
BY **Caframo** 

**Sirocco II - 12/24V premium cabin fan**

- Ultra quiet motor w/ low power consumption
- Long motor life of 20,000 hours
- 3 speed levels & 4 timer settings possible
- 360° ventilation
- Premium design w/ stainless steel protective grating

Power consumption: 12V: 0.12A to 0.35A; 24V: 0.06A to 0.21A (4.2W at highest level at 12V) Dimensions: Ø 18cm, W 35 x H 27.3 x D 14cm. Weight approx. 0.82kg.

Color: White	<b>462887</b>	<b>199,-</b>
Color: black	<b>462892</b>	<b>199,-</b>



**TOP SELLER**



**12V  
24V**



**12V**



**12V**



**12V**

**Bora - 12V cabin fan**

- 3-level touch control
- Adjustable angle
- Long life 5000+ motor with low power consumption
- Compact design
- Easy to install
- Upright or downward lateral mounting

Newly developed high-performance blade with high efficiency. Maximum airflow at minimum noise level, fan speed adaptation to the use. Fully protected on the front and back. Locking lug holder. Power consumption: 12V: 0.15A to 0.27A; 24V: 0.06A to 0.18A (3.24W at highest level at 12V), approx. dimensions: Ø15 cm x W16.5 x H 24.1 x D 7.6cm. Weight approx. 0.58kg.

Color: White	<b>462882</b>	<b>144,-</b>
--------------	---------------	--------------

**Maestro - 12V fan incl. LED light**

- Integrated LED light, changeable white to red
- Operation via wired remote control
- Adjustable speeds
- Very quiet operation

Power consumption: 12V: 0.15A to 0.28A (3.36W at highest level at 12V). W 16.5 x H 21.5 x D 8cm. Weight approx. 0.8kg.

Color: Black	<b>462893</b>	<b>164,-</b>
--------------	---------------	--------------

**Ultimate - One of the quietest and most powerful 12V fans in its class**

- Two speed settings
- Low power consumption
- Without protective grating, w/ FingerSafe
- Two mounting options: Permanent or with removable suction cup
- Long motor life
- Adjustable tilt head
- With adapter for cigarette lighter

Quiet, reliable operation. Direct airflow in all directions. Easy to install.

Easy to clean. Power consumption: 12V: 0.28A to 0.40A; 24V: 0.13A to 0.18A (4.8W at highest level at 12V). Approx. dimensions: Ø 18cm, W 13.34 x H 20.3 x D 6.3cm. Weight approx. 0.48kg.

Color: White	<b>462885</b>	<b>102,-</b>
Color: Black	<b>462886</b>	<b>102,-</b>



# STORAGE COMPARTMENTS & STORAGE NETS



## Pocket storage

The multifunctional shelves are suitable for installation throughout the vehicle, from the cabin to the rear, from the toilet to the kitchen. Made from durable plastic. Mounting with screws supplied.

① **Pocket tray M, white:**  
Weight: 0.1 kg, dim.: W26 x D8 x H8.5 cm. **SA1086 8,70**

② **Pocket tray L, white:**  
Weight: 0.1 kg, dim.: W26 x D8 x H16.5cm. **E662 10,80**

③ **Pocket Tray XL, grey:**  
Weight: 0.3kg, Dims.: W38 x D10 x H16cm. **46213 16,70**

## Pocket Plus trays

Material: polymer, scope of delivery: tray, screws & spacers.

④ **Pocket Plus Tray M, capacity 1.2 liters, cream white:**  
Weight: 0.1kg, dims.: W 26 x H 9 x D 8.5cm. **46271 12,70**

⑤ **Pocket Plus tray L, capacity 4.4 liters, cream white:**  
Weight: 0.4kg, dimensions: W 38 x H 14 x D 11.5 cm. **46041 20,-**



## Storage nets in 4 sizes

- Wide range of applications
- Elastic mesh
- Quickly and easily attached

The storage nets provide a firm hold for your utensils. Available in 4 sizes. Scope of delivery: Storage net, profile frame and mounting material. Black color.



Robust profile frame

<b>Storage net S</b> , W 20 x H 26.5cm	<b>461945</b>	<b>12,95</b>
<b>Storage net M</b> , W 27 x H 26.5cm	<b>461946</b>	<b>14,95</b>
<b>Storage net L</b> , W 35 x H 26.5cm	<b>461947</b>	<b>16,95</b>
<b>Storage net XL</b> , W 45 x H 26.5cm	<b>461948</b>	<b>18,95</b>



3 sizes available: S, M and L

## Aluminum storage compartments incl. elastic net

- Stable aluminum frame and elastic mesh
- Shelves are pre-assembled & can be attached directly
- 6 holes in aluminum profile for easy wall mounting

Create additional storage space for your utensils in your vehicle. The storage compartments are available in 3 sizes with pre-mounted mesh. (Delivery includes mounting material). Color aluminum frame and net: black.

<b>Storage compartment S</b> , W 33.5 x H 18.5 x D 8cm	<b>461942</b>	<b>24,95</b>
<b>Storage net M</b> , W 39 x H 20 x D 8cm	<b>461943</b>	<b>29,95</b>
<b>Storage compartment L</b> , W 45 x H 22.5 x D 8cm	<b>461944</b>	<b>34,95</b>

## Storage compartments



Fig. shows a compilation of nets and aluminum frames.

### ① Storage nets for aluminum frames (supplied w/o frame)

Size S, 30.2 x 16.9 cm	<b>46196</b>	<b>11,95</b>
Size M, 36.6 x 18cm	<b>46194</b>	<b>17,95</b>
Size L, 41.5 x 21cm	<b>46195</b>	<b>22,95</b>

### ② Alu frame for storage nets (supplied w/o net)

Size M, 39 x 20 x 8 cm, for net 46194	<b>461940</b>	<b>35,95</b>
---------------------------------------	---------------	--------------

## Kiiper storage nets

The Kiiper nets are open at the bottom. For motorhome, caravan or camper. Can be mounted horizontally or vertically on wall, ceiling or floor. The elastic nets are available in 8 sizes, color black.



<b>L 20 x H 25cm</b>	<b>47510</b>	<b>19,95</b>
<b>L 27 x H 25cm</b>	<b>47511</b>	<b>21,95</b>
<b>L 35 x H 25cm</b>	<b>47512</b>	<b>26,95</b>
<b>L 45 x H 25cm</b>	<b>47513</b>	<b>33,95</b>

### Mini version

<b>L 20 x H 4cm</b>	<b>47519</b>	<b>11,95</b>
<b>L 40 x H 4cm</b>	<b>47520</b>	<b>13,95</b>
<b>L 20 x H 13cm</b>	<b>47521</b>	<b>14,95</b>
<b>L 40 x H 13cm</b>	<b>47522</b>	<b>16,95</b>

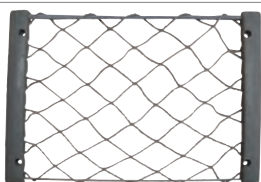

## Storage net for door

Sturdy holding frame. Dimensions: approx. 31.5 x 21.5cm. Grey plastic, incl. 4 screws and covers.

**461941 7,50**

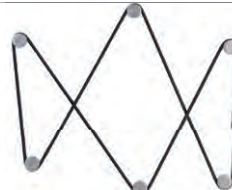

## Storage & clamping system set

Consists of: 2m round cord, 6 fastening knobs with screw caps and connector.

**919261 16,95**

Delivery of all items without decoration





## Volkswagen Transporter 4 Storage console

For model year 1990 to 2003 with unpadded dashboard without airbag. Elegant design with universally usable division. Color grey. L 37 x W 20 x H 5cm.

46200 29,95

## Volkswagen Transporter 2 / 3 storage console

For all Volkswagen utility vehicles YOC 1979 - 1990. L 60 x W 17 x H 8 cm. Black color.

46190 33,95



## Practical center trays

- Poplar plywood coated w/ anthracite leather design
- Anthracite edging
- Base plate with anti-slip coating

① For Volkswagen Transporter 6 / 5, Multivan Startline and Transporter with storage compartment flap in the center of the dashboard > 05/2003 and 2015. Not for Multivan Comfortline.

46395 157,-



② For Fiat Ducato ≥ 2006 and 2013 suitable for vehicles with pleated blinds for darkening the windshield. Material: Poplar plywood coated with imitation leather in black, black edging, base plate with anti-slip coating.

46394 118,-



MADE IN GERMANY



Scan QR code and watch the product video.



## Glove compartment tray – for smartphone/tablet including cup holder

Suitable for Fiat Ducato, Peugeot Boxer, Citroën Jumper & RAM Promaster, ≥ 2006, if middle glove compartment is installed.

Storage compartment with 2 cup holders and the option to safely place smartphone(s) or tablet (smartphone can be placed at an angle to read the navigation). Breakthrough to open when needed for charging cable in the smartphone compartment. With additional buffers and anti-slip inserts to prevent noise. Glove compartment remains completely intact: is simply inserted into the open glove compartment.

462031 103,-

**Froli**



## Storage Fiat Ducato > 1994

With space for 2 cans/bottles 0.33l, pens, sunglasses, coins and much more, as well as a universal compartment. Color anthracite. L 470 x W 225 x H 12 mm.

46203 41,95

## DOOR STORE – More storage space in Volkswagen Transporter 6 / 5 sliding doors

- Quickly installed
- 3 separate compartments, easy to clean
- Made in UK
- Including 20 mounting clips for installation

Use the cavities in your VW T5/T6 sliding doors. After installation, carefully check that there is no contact between the Door Store and the vehicle when the door is opened. Please note: The Door Store cannot be used if the door release cable is routed through the hole in the center cavity.



Left sliding door



461990 332,-

Right sliding door

461991 332,-





**Doormat** for indoor use Material: 100% coconut, dims.: 50 x 25cm  
 Decor "Motorhome" **51649 8,50**  
 "Caravan" decor **51651 8,50**  
 Decor "Holiday Travel" **51657 9,50**



**Doormat DERBY FLOCK**

for indoor use Material: 100% Polypropylene, dims.: 50 x 25cm  
 Decor "Camper" **51660 8,50** "Caravan" decor **51661 8,50**



**Kera Kamp doormat** Dimensions: 40 x 60cm, motive: motorhomes and caravans. Material: PP/rubber

**Green Flock doormat** Dimensions: 40 x 60cm, motive: caravan. Material: PP/rubber

Black **51668 9,50**  
 Grey **51669 9,50**

Caravan **51671 10,95**  
 Motorhome **51675 10,95**



**"I love Camping" doormat**

Motive: camper, with non-slip coating on the back Material: coconut fibers / rubber,

Dims.: 25x50cm **516401 8,95**  
 Dims.: 40x60cm **516402 12,95**



**"Camper dog & cat" doormat**

Material: Recycled rubber granules + PU.

Dims.: 25x50cm **516610 12,95**



**"I love Camping" doormat**

Motive: caravan, with non-slip coating on the back Material: coconut fibers / rubber,

Dims.: 25x50cm **516403 8,50**  
 Dims.: 40x60cm **516404 12,95**



**Doormat Coco Brush**

Material: 100% coconut fiber, base: vinyl. Dimensions: 30 x 35 x 3cm

**516792 15,95**



**Doormat Life is a Journey**

Sturdy doormat, black with colored logo print. The rubberized back prevents slipping. Perfect for the living space in the vehicle, for the awning or for at home. Size: 60 x 40cm **516431 19,95**



**Living room rug Runner Kamper**

Motive caravan. Easily adjust size with scissors. Washable at 30°C. Material: 55% cotton, 45% polyester **50x150cm in grey 516480 23,95**



**Master Camp - Living room rugs, 50cm wide**

Fresh and cheerful design as a carpet for camper or caravan. Washable at 30°C. Material: Polypropylene/TPR

**Grey150x50cm 516482 21,95**



**Doormat Camper**

Dimensions: 40 x 60cm, Motive: motorhomes Material: PP/rubber

Black **51667 9,50**



**Doormat Nevada**

Dimensions: 60 x 40cm. For entrance area Color grey

**51643 11,95**

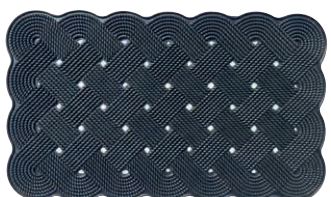

**Rubber doormat Love Knot**

Dims.: 47x62cm, material: 100% rubber, hand washable max. 30°C

Black **516642 19,95**



**Rubber doormat Twin**

Dims.: 47x62cm, material: 100% rubber, hand washable max. 30°C

Black **516641 19,95**

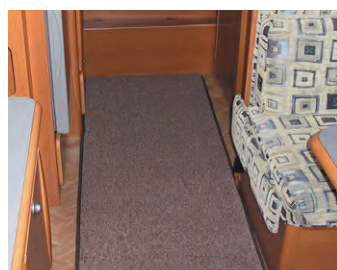

**Velour floor mats**

- High quality and durable
- Upgrading the cab with a homey character
- Insulating coating against cold and heat
- Color medium gray

**80 x 50 cm 51645 15,95**  
**100 x 50 cm 51646 19,95**  
**150 x 50 cm 51647 25,95**

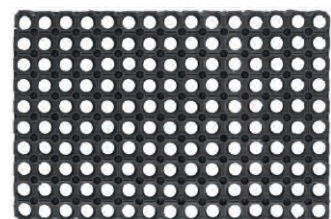

**Doormat rubber**

Material: 100% rubber  
 dims.: 60 x 40 x 2cm

Mat **51664 10,50**  
 Connection set **516640 2,50**







**Artificial grass doormat**

Material: 100% polyethylene  
 Dims.: 60 x 40cm

**NEW: Black 516601 9,95**  
 Grey **51662 9,95**



<b>RUBBER FLOOR MATS</b> Solid rubber	<b>PREMIUM FLOOR MATS</b> Soft PVC	<b>BASIC FLOOR MATS</b> Needled fleece carpet	<b>PLUS FLOOR MATS</b> Needled fleece velour carpet	<b>EXQUISITE FLOOR MATS</b> Velour carpet
 Top / Bottom	 Top / Bottom	 Top / Bottom	 Top / Bottom	 Top / Bottom
<ul style="list-style-type: none"> <li>• Upper with grid structure</li> <li>• Protects the interior perfectly from moisture</li> <li>• Nubbed underside prevents slipping</li> <li>• Color: Black</li> </ul>	<ul style="list-style-type: none"> <li>• 10mm thickness</li> <li>• Hygienic</li> <li>• Easy to clean</li> <li>• 100% PVC, recyclable</li> <li>• Anti-slip bottom</li> <li>• Antistatic</li> <li>• Color: Black</li> </ul>	<ul style="list-style-type: none"> <li>• Needled fleece top</li> <li>• Hemmed edges - no fraying</li> <li>• Back with non-slip plastic structure</li> <li>• Color: Anthracite</li> </ul>	<ul style="list-style-type: none"> <li>• Top made of dense needled fleece velour</li> <li>• Back with non-slip rubber granules</li> <li>• Hemmed edges - no fraying possible</li> <li>• Color: anthracite melange</li> </ul>	<ul style="list-style-type: none"> <li>• High quality upper made of soft velour w/ elegant look</li> <li>• High quality edging</li> <li>• Non-slip rubber back</li> <li>• PU back coating for even more insulation</li> <li>• Color: Black</li> </ul>

Vehicle type	YOC	Rubber mats (solid rubber)		Premium floor mats		BASIC Floor mats		PLUS Floor mats		EXQUISIT Floor mats	
Fiat Ducato/Peugeot Boxer/Citroën Jumper	1994 - 2002			515803	53,95			51561	89,95	516018	137,-
Fiat Ducato/Peugeot Boxer/Citroën Jumper	2002 - 2006	51680	44,95	515802	44,95	51622	38,95	51567	77,95	516017	137,-
Fiat Ducato/Peugeot Boxer/Citroën Jumper	2006 - 2014	51681	45,95	515801	39,95	51673	39,95	515711	77,95	516051	137,-
Fiat Ducato/Peugeot Boxer/Citroën Jumper	> 2014	51681	45,95	515800	33,95	51674	39,95	515711	77,95	516051	137,-
Opel Movano	> 2021	51681	45,95	515800	33,95	51674	39,95	515711	77,95	516051	137,-
Volkswagen Caddy / Volkswagen Caddy Maxi	2008 - 2020	516802	33,95					515712	71,95		
Volkswagen Caddy / Volkswagen Caddy Maxi	> 2020	516814	29,95					516019	71,95		
Volkswagen Transporter 4	> 9/1995	516803	38,95			51625	40,95	51557	89,95	516022	137,-
Volkswagen Transporter 5	> 2003	516804	44,95	515804	53,95	51626	40,95	51579	77,95	516025	137,-
Volkswagen Transporter 6.1 / 6	> 2015	516805	44,95	515805	36,95	51578	32,95	51579	77,95	516025	137,-
Volkswagen Transporter 7	> 2024	516817	49,95	516352	39,95						
Volkswagen Transporter 7 Caravelle	> 2024	516818	49,95	516352	39,95						
Volkswagen Multivan / VW California >2024	> 2021	516816	42,95			516357	39,95	515713	77,95	516053	145,-
Volkswagen ID.Buzz	> 2023	516819	44,95								
Volkswagen Crafter/MAN TGE	> 2018	516811	45,95					516026	77,95	516027	137,-
MB Sprinter / Volkswagen Crafter	2006 - 2018	51683	49,95	515806	53,95	51634	40,95	516030	83,95	51606	137,-
MB Sprinter / Volkswagen LT	1996 - 2006	51683	49,95					516031	83,95	51602	137,-
Mercedes-Benz Sprinter	> 2018	516812	49,95			516039	39,95	516028	77,95	516029	137,-
Iveco Daily	> 2014	516806	36,95								
Renault Trafic / Nissan NV 300 / Fiat Talento	> 2014	516801	43,95					51581	77,95	516032	137,-
Opel Vivaro B	2014-2019	516801	43,95					51581	77,95	516032	137,-
Mercedes-Benz Vito / Viano	2003-2014	516809	34,95								
Mercedes-Benz Vito / V-Class / Pössl Campstar / Vanstar	> 2014	516810	34,95			516341	36,95	516033	77,95	516021	137,-
Ford Transit	2000-2013	516808	26,95			51627	41,95				
Ford Transit (handbrake left)	2004 - 2006					51629	40,95				
Ford Transit (handbrake left)	2006 - 2013					516351	39,95	515731	89,95	516034	137,-
Ford Transit Custom	> 2014	78098	38,95			516352	39,95	516035	77,95	516036	137,-
Ford V710 Transit Custom	> 2023	516817	49,95			516352	39,95				
Ford V710 Tourneo Custom	> 2023	516818	49,95			516352	39,95				
Citroën Spacetourer/Jumpy/Peugeot Traveller/Expert/Toyota Proace Verso/Pössl Campster/Vanster	> 2016	516800	33,95			516353	39,95	516037	77,95	516038	137,-
Opel Vivaro C/Zafira Life	> 2020	516800	33,95			516353	39,95	516037	77,95	516038	137,-
Fiat Scudo/Ulyssee	> 2022	516800	33,95			516353	39,95	516037	77,95	516038	137,-

**NOTE:** Dimensions are adjusted to 2 single seats in the cabin, not suitable for double bench seats.



# ENTRANCE MATS / FLOOR MATS

**CARBEST** 

High-quality premium material



## Entrance mat sets

High-quality entrance mat sets to protect the vehicle interior from moisture and dirt.

Set of 2 = 2 cabin mats

Set of 3 = 2 cabin mats + 1 sliding door mat

Set of 4 = 2 cabin + 2 sliding door mats

Vehicle type	① Color grey with black edge		② Color striped anthracite (set of 2)	
	Code	Price	Code	Price
Volkswagen ID. Buzz			51815	19,95
Volkswagen Transporter 4			51801	19,95
Volkswagen Transporter 6 / 6.1			51802	19,95
Volkswagen Multivan >2021 / California >2024			51804	19,95
Mercedes-Benz Vito/Viano > 2014	516013 (set of 3)	59,95	51813	19,95
Citroën Spacetourer > 2016	516012 (set of 4)	69,95	51689	18,95
Fiat Ducato > 2006	516016 (set of 2)	49,95	51806	19,95
Fiat Ducato > 2014	516016 (set of 2)	49,95	51808	19,95
Volkswagen Crafter > 2018			51800	19,95
Mercedes-Benz Sprinter 2014 -18			51811	19,95
Mercedes-Benz Sprinter > 2018	516014 (set of 2)	49,95	51800	19,95
Ford Transit > 2014			51809	19,95
Ford Transit Custom > 2016	516015 (set of 2)	49,95	51810	19,95
Ford V710 > 2023			51819	15,95



**HEOSdoor mat®**

## Doormat for cabin entrances

- Use without additional fastening, precisely adapted to the entrance of the vehicle
- Contents: 2 cabin mats
- 100% polypropylene, color: anthracite

Volkswagen Transporter 6 / 5 (set of 3 = 2 cab mats + 1 sliding door mat)	51670	59,-
Ford Transit, Ford Nugget > 2000	516075	28,95
Renault Master, Opel Movano, Nissan NV 400 > 2010	516077	28,95
Renault Master, Opel Movano YOC. 2000-2010, Iveco Daily YOC. 2000-2014	516076	28,95
Duc. 230/244, Boxer, Jumper YOC 1994-2006	51607	28,95
Duc. 230/290, Boxer Jumper YOC 2006-2019	516072	28,95
Fiat Ducato > 09/2019	516079	28,95
Mercedes Sprinter YOC 2006-2018	516074	28,95
Mercedes-Benz Sprinter > 2018	516070	28,95



**ADRIA**  
Freizeit mit noch mehr Komfort

## Entrance mat specially for Adria motorhomes

Size 45 x 21cm, anthracite color

51616 12,95

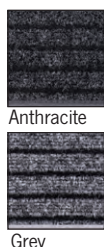

## Floor mats/carpets for Campster/Vanster/Campstar/Vanstar by Pössl, Citroën Spacetourer, Peugeot Traveller, Mercedes Vito & similar

Mats for the footwell under the dashboard, entrance, trunk and living area. Material: synthetic fiber 1900g/m<sup>2</sup> in grey and anthracite, each with black stripes.

Carpet for	For Citroën Spacetourer, Peugeot Traveller, Pössl Campster			For Citroën Spacetourer, Peugeot Traveller, Pössl Vanster			For Mercedes Benz Vito, Pössl Campstar			For Mercedes Benz Vito, Pössl Vanstar		
	Color grey	Color anthracite	Price	Color grey	Color anthracite	Price	Color grey	Color anthracite	Price	Color grey	Color anthracite	Price
① Cabin	51686	51687	53,95	51032	51033	51,95	51700	51701	53,95	51714	51715	53,95
② Cabin entrance (2pcs.)	51688	51689	15,95	51688	51689	18,95	51702	51703	18,95	51702	51703	18,95
③ Living space entrance	51698	51699	20,95	51698	51699	20,95	51704	51705	20,95	51704	51705	20,95
Living space without rails	51690	51691	53,95	516000	516001	51,95	51706	51707	55,95	51720	51721	55,95
④ Living space with rails	51692	51693	61,95	516002	516003	59,95	51708	51709	63,95	51722	51723	63,95
Trunk without rails	51694	51695	46,95	516004	516005	45,95	51710	51711	52,99	51724	51725	53,95
⑤ Trunk with rails	51696	51697	56,95	516006	516007	55,95	51712	51713	59,95	51726	51727	63,95



**Floor heating for caravans & motorhomes**

- Safe operation via 230V transformer (foil 48V)
- Ultra-thin film, only 0.3mm thick
- Easy subsequent installation (foil is placed on floor and fixed w/ adhesive tape 870131)
- Perfect adaptation to floor surface possible
- Top heat distribution & high heat output: 80 watts /sqm

① Heating foil, W: 43 cm, 5 meters	870110	103,-
① Heating foil, W: 53 cm, 5 meters	870112	133,-
20 meters	870113	533,-
① Heating foil, W: 69 cm, 5 meters	870114	192,-
<b>Conversion from 230 V to extra-low safety voltage (48V):</b>		
② Crimping pliers (for assembly)	870125	76,95
③ <b>Terminals</b> - for connecting the installation cables to the foil.		
Dimensions: 27.2 x 12.5mm, 10 pieces	870134	19,95
<b>Cable for the heating foil, 10 meters</b>	870116	29,95
<b>Adhesive tape for heating foil</b> transparent, 20 mm, 20 m roll GP* 0,30 / 1m	870131	5,95
<b>Accessory set for installation</b> (Contents: double-insulated RTK cable 6.25m, 16 connection terminals, insulating tape, sealing tape, yellow label, sticker & install instructions)		
④ <b>Transformer 250 VA</b>	870135	59,95
④ <b>Transformer 350 VA</b>	870123	199,-
④ <b>Transformer 500 VA. Secondary voltage 34 - 42 - 48V.</b>	870124	194,-
<b>Dimensions 23x17x9 cm</b>	870119	359,-



**Heated cab floor mat for Fiat Ducato 230V**

- Insulated against cold from below
- For Fiat Ducato, Peugeot Boxer, Citroën Jumper from YOC 7/2006
- Luxury version. 230 volt. 71 watts. 1 piece for the entire cabin
- 51609 370,-



**12 volt floor heating**

- Short warm-up time
- Low power consumption
- Cost-effective to purchase and operation (use)
- Flexible & easy to install
- Maintenance-free & silent
- No dust swirling

Less than 1mm thick, flexible material. The fiber-glass fabric is made of heat-conducting carbon fibers that produce a pleasant heat in a few minutes.

**Technical data:** Voltage: 12 volt, power: approx. 160 Watt /m<sup>2</sup>, connection cable: approx. 2 m w/ universal plug

<b>Size 50 x 100cm</b>	87040	126,-
<b>Size 50 x 150cm</b>	87041	179,-



**12V and 230V heating carpets**

- Bottom with anti-slip mat
- High quality
- Short start-up time approx. 10 minutes
- Comfy temperature up to about 30 degrees

**12 volt heating carpets:** Power: from approx. 35 watts to approx. 90 watts, connecting cable: approx. 2m with universal plug

① Light brown 60 x 40cm	87042	93,95
① Light brown 60 x 70cm	87043	135,-
② Orange brown 60 x 70 cm	87013	

**230 volt heating carpets 230V**

③ silver 60 x 70cm, app. 60W	87050	135,-
③ Silver 60 x 100cm, app. 90W	87051	167,90
④ Brown 60 x 70cm, app. 50W	87023	135,-
④ Brown 60 x 100cm, app. 70W	87022	159,-

**230V felt heating carpets**

- Surface material felt, color grey
- Surface temperature: 40°C - 50°C
- Overheating protection
- Voltage: 230 volt, 50Hz
- Protection type/class IP 20 / II

<b>60 x 45cm</b>		
230V / 65W, weight 1.5kg	87054	153,-
<b>100 x 60cm</b>		
230V / 170W, weight 2.5kg	87055	219,-



BP\* = Base price per specified unit



# ORGANIZER FOR CABIN SEATS / WINDOWS POCKETS / BACKREST CUSHIONS



**CARBEST**

## Felt seat organizer universal

- For driver's or passenger's seat
- With retaining strap (elastic) on armrests & hook for fastening under seat
- Large bag also suitable for laptop

Material felt, color anthracite Dims.: W42 x H76cm.

919172 19,95



← Stretchable 33 to 66 cm →



## Utensil pocket system as window covering

**Pockets** For attaching to the sturdy window panels using Velcro tape. The pockets for the window panels can be combined very well:

- |   |        |       |
|---|--------|-------|
| ① small bag, 36 x 20 x 5cm (w/o fig.)             | 919160 | 26,95 |
| ② medium bag, 45 x 26 x 6cm                       | 919161 | 42,95 |
| ③ large bag, w/ thermo inner pocket 28 x 48 x 9cm | 919162 | 54,96 |

- ④ **Window panels** – for darkening and holding the window pockets

All Volkswagen Transporter 6/5 KR station wagons w/o comfort trim & California Beach/Multivan Startline KR up to 2009.

Left 9191680 109,90  
Right 9191681 109,90

For Mercedes-Benz Vito "long" without comfort paneling, glazed  
Left 9191684 109,90  
Right 9191685 109,90



④ For Renault Traffic KR and identical vehicles such as Opel Vivaro, Nissan NV 300, Fiat Talento glazed, without comfort paneling  
Left side 9191686 109,90  
Right 9191687 109,90

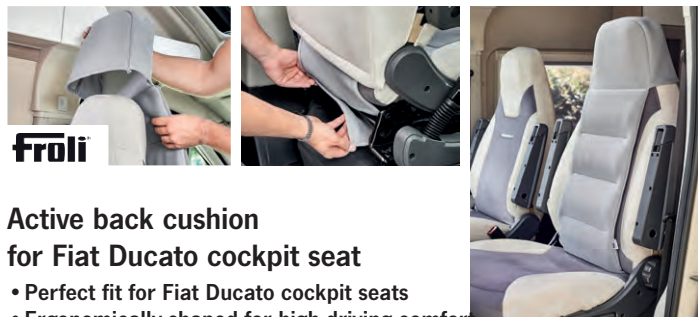

## Active back cushion for Fiat Ducato cockpit seat

- Perfect fit for Fiat Ducato cockpit seats
- Ergonomically shaped for high driving comfort
- Breathable 3D AirMesh cover with side zipper
- Washable up to 60°C

The active back cushion is simply slipped over the headrest and fastened at the lower end using the integrated Velcro fastener. Side zipper for replacing the plastic slats. Color grey.

930090 58,95



## Organizer for cabin seats

- Holding mat with 4 pockets for the back of the back of driver's and passenger's seats
- Secure hold due to attachment w/ eyelets (on headrest) & 4 elastic bands
- Universal use, thanks to adjustable attachment to armrest, seat and headrest
- Chic imitation leather look in 2 color options

Holding mat with 4 pockets. Dimensions: 1 pocket: 32 x 20cm, 2 pockets: 21 x 19cm, 1 pocket: 44 x 28cm. Pockets are closed with Velcro. Weight approx. 0.8kg.

- |                      |        |       |
|----------------------|--------|-------|
| ① Color black - grey | 919167 | 46,90 |
| ② Color black        | 919180 | 46,90 |



**Froli**

## Active back cushion

- For healthy mobility
- Easy to attach due to practical fastening system
- Breathable 3D AirMesh cover with side zipper
- Washable up to 60°C



Back cushion with slatted spring core for more ventilation and relief. Use in all travel vehicles, including seats with side airbags. Also suitable for office chairs. Approx. dimensions: L60 x W30cm. Black color.

93009 40,90





Window pockets for

- Ford Transit Custom + Tourneo Custom V710 >2023
- Pössl Campster / Citroën Spacetourer and similar models

- Attachment without screws & removable at any time
- Extra storage space
- Blackout function
- Robust, durable material

Side window bag rear left and right. Provides more storage volume in the interior. With two mesh outer pockets, carrying handle and blackout function. Material: 100% polyester, load capacity: max. 5kg

① NEW: For Ford Transit Custom V710 >2023 (without interior cladding)

rear left  
Dims. app. L 91 x H 49 x W 13cm      919183      99,95

rear right  
Dims. app. L 91 x H 49 x W 13cm      919184      99,95

② New: For Ford Tourneo Custom V710 >2023 (with interior cladding)

rear left  
Dims. app. L 81 x H 43 x W 14cm      919189      99,95

rear right  
Dims. app. L 75 x H 43 x W 14cm      919190      99,95

③ For Pössl Campster / Citroën Spacetourer, Peugeot Traveller, Opel Zafira Life, Toyota Proace Verso, all lengths M (L2).

Dimensions: 66cm x 41cm x 18cm

rear left      919175      59,95

rear right      919176      59,95



Ford Transit Custom V710

from 59,95



Pössl Campster / Citroën Spacetourer



Ford Tourneo Custom V710



89,95

Volkswagen Transporter 6 / 5 window bag

- For Volkswagen Transporter 6/5 California Ocean, Coast and Beach from YOC 2003, side window rear right
- Large storage volume w/ 2 interior compartments
- 1 mesh outer pocket & 1 closed outer pocket for phone, glasses, watch, reading stuff etc.
- Very easy installation without tools and without modification to vehicle

Blackout function, with carrying handle. Material: artificial leather (robust, easy to clean and odorless). Dimensions: approx. 80 x 46,5 x 12cm

919169      89,95



Window bags for VW Caddy 5 Maxi >2020



160,-

- For attachment to window pane
- Removable bag with handle
- for rear windows right & left
- Attachment of bag to panel with magnet + clips

2-piece set consisting of panel for attachment to window pane and bag. Color: Black.

Rear left      919181      160,-  
Rear right      919182      160,-



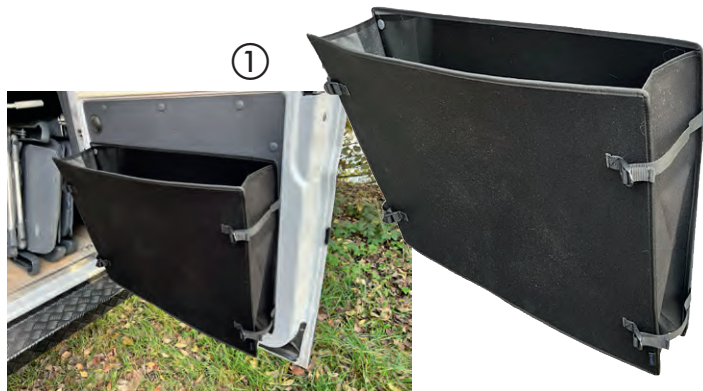

**AIRTUNE HECKBAG in 3 sizes – ideally suited for Fiat Ducato, Citroën Jumper, Peugeot Boxer**

- Large rearbag for space-saving storage of camping chairs and tables, for example
- Small pockets to optimize storage space in motorhomes
- Bag depth can be installed using adjustable straps
- Easy to attach

The AIRTUNE HECKBAGS are practical bags for easy attachment to the rear doors or in the interior of motorhomes. This allows you to make the best use of the available space in the vehicle



① **REAR BAG (1/1)**  
L68 x W50 x D1-15cm, weight approx. 0.85kg **919185** **69,95**

② **REAR BAG (1/2)**  
L34 x W50 x D1-15cm, weight approx. 0.5kg **919186** **39,95**

③ **REAR BAG (1/4)**  
L34 x W25 x D1-15cm, weight approx. 0.3kg **919187** **29,95**

**HOW TO USE:**

The bag is mounted on the inside of the rear doors or in the vehicle interior to save space when storing items. To attach, simply mount the bag using the interior dowels on the inside of the door or using the appropriate adhesive screws (the back of the bag must be drilled to fit).



**Adhesive holder for rear bags (set of 5)**

- Set consists of 5 adhesive holders
- For easy attachment of the rear bag to the rear doors of motorhomes
- self-adhesive, without drilling
- Transparent
- Dimensions: 50 x 80mm

**919188** **4,95**



**Even - Comfortable reclining and sleeping mat for Volkswagen Multivan and California Beach**

- More sleeping comfort in the Multivan and California Beach
- Compensates for different heights in seat bench
- Consisting of two chambers

Dims.: 198 x 152 x 7cm (LxWxH), pack size: Ø 28 x 70cm Weight approx. 4.5kg **93075** **219,-**



Stand separately inflatable and removable



**Rear bench air mattress for cars, SUV, sedans**

- Mattress & stand separately inflatable & separable
- Can also be used as mattress for camping in a tent or at home w/o stand
- Includes 2 inflatable cushions
- Includes 12V air pump with 3 adapters
- Including bag and repair kit

Dims. L 137 x W 84 x H 8cm / foot 30cm high  
Material: PVC + velour, color grey, weight approx. 2kg



**12V air pump included**

**93088** **43,50**



**Sleeping set for WALLABY II roof tent**

- Specially developed for the WALLABY II (Art. 900633)
- The tried and tested Froli sleeping comfort now also for roof tent
- Special cold foam core approx. 40mm high
- Double fabric cover, color: anthracite
- Recesses with matching inserts
- Zipper in the middle
- The spring mat is divided into two parts

Dimensions: approx. L 230 x W 135 x H 4cm      **590248**      749,-



**NEW**



**Note: The Wallaby II roof tent can be found on page 70**

**Foldable sleeping module for Volkswagen Multivan >2021**

**NEW**

- Dimensions: overall length 195cm, width 130cm
- Upholstery structure with special foam and Froli spring elements
- Cold foam core RG 56
- Compression firmness 7.2kPA (firm)
- Upper with double fabric cover, 100% polyester Bottom AirMesh fabric
- Support feet as an option for 5-seater vehicles

The sleeping module is folded up in the rear of the vehicle to save space. The upholstered structure offers very good sleeping comfort and pressure relief. Ideal addition for short trips in a VW Multivan >2021.

Sleeping module dimensions: 3-part folding, anthracite



- ① **Sleeping module for Volkswagen Multivan >2021**  
3-part folding, anthracite, height 7.5cm, length 202cm, width 130cm  
**590246**      849,-
- ② **Support leg set (for 5-seater vehicles)**  
made of wood with support plates      **590247**      89,95





## ADDITIONAL CABIN BEDS



**CARBEST**

### Additional cabin beds

- 7cm cold foam mattress + 1cm MDF panel
- Removable and washable cover (polyester)
- Twice foldable (weight approx. 11 kg)
- Colour: Grey



Illustration shows item 421743



Order at the same time: **Carrying bag** (suitable for all beds)



Folds up in less than 30 seconds.



Vehicle type	Bed dimensions open	Bed dimensions folded	Item no.	Price
Fiat Ducato (also Ducato 8), Peugeot Boxer, Citroën Jumper > 2002	160 x 74 x 8 cm	80 x 74 x 16 cm	421742	215,-
Volkswagen Transporter 6.1 / 6 / 5 / 4	149 x 64 x 8 cm	74,5 x 64 x 16 cm	421743	215,-
Volkswagen Crafter, MAN TGE > 2017	160 x 74 x 8 cm	80 x 74 x 16 cm	421744	225,-
Mercedes Benz V-Class, Vito Tourer from YOC 2014	146 x 70 x 8 cm	70 x 73 x 16 cm	421745	225,-
Mercedes-Benz Sprinter > 2018	160 x 74 x 8 cm	80 x 74 x 16 cm	421746	225,-
Renault Trafic, Fiat Talento, Nissan NV300, Opel Vivaro > 2002	144 x 70 x 8 cm	72 x 70 x 16 cm	421747	225,-
Ford Transit Custom > 2013, Ford V710 > 2023	152 x 65 x 8 cm	76 x 65 x 16 cm	421748	225,-
Citroën Spacetourer/Jumpy, Peugeot Expert/Traveller, Toyota Proace, Opel Zafira, Fiat Scudo > 2015	140 x 70 x 8 cm	70 x 70 x 16 cm	421749	225,-
① Order at the same time: Carrying bag (suitable for all beds)			421750	49,95

Picture shows 421748

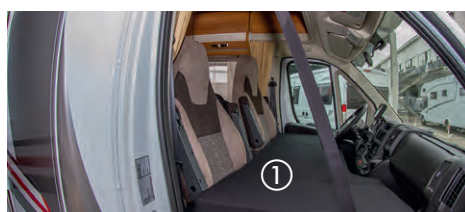

### CampSleep - extra bed for the cabin

- Stabilization with belt from bed to handle (passenger)
- Durable fabric, removable and washable
- Lateral wooden plate reinforcement for upper body
- Mattress thickness 10cm
- Option: protective bag against dirt

Suitable for the following vehicles:

Cabin in motorhomes (2-seater) > 2005, e.g.: Ducato / Sprinter / Transit / Crafter / Boxer / Mastier / Jumper / Daily / Movano > 2021

CampSleep is unfolded twice. Total length from door to door about 160 cm.

The depth to the glove box is about 74cm, to the steering wheel about 44 cm.

Weight approx. 7 kg.

- ① CampSleep, left-hand drive 42173 409,-
- ② CampSleep, right-hand drive 42175 419,-



### ③ CampSleep Small - additional bed for cabin in small commercial vehicles

The comfortable additional bed for the cabin of the smaller commercial vehicle class, e.g. VW T7/T6/T5, Mercedes Vito, Ford V710, etc. The bed is only folded out twice. This makes it convenient to create another sleeping option on the seats in the cabin. Dimensions: 148 x 64 x 10cm. Weight only about 6 kg.

- CampSleep Small, left-hand drive 42174 309,-
- CampSleep Small, right-hand drive 421741 206,-

### Protective bag for CampSleep extra beds (not shown)

Practical protective bag. Protects against dirt and dust.

- Dimensions: 85 x 86 x 25cm 421731 40,-



**Foldable topper**

Mattress padding for sleeping bench, foldable

- Compensates for unevenness
- High sleeping comfort
- Comfortable fabric
- Lightweight and + small pack size
- Includes practical transport bag

The foldable topper, tailor-made for Volkswagen Transporter 6 / 5 Marco Polo (Horizon and Activity) and Pössl Campster.

Compensates for the unevenness given by the sleeping bench. The additional mattress topper increases sleeping comfort enormously. The folding function makes it easy to store and transport, so you can always find a place for your foldable topper. Material: polyester fabric cover, cold foam mattress.

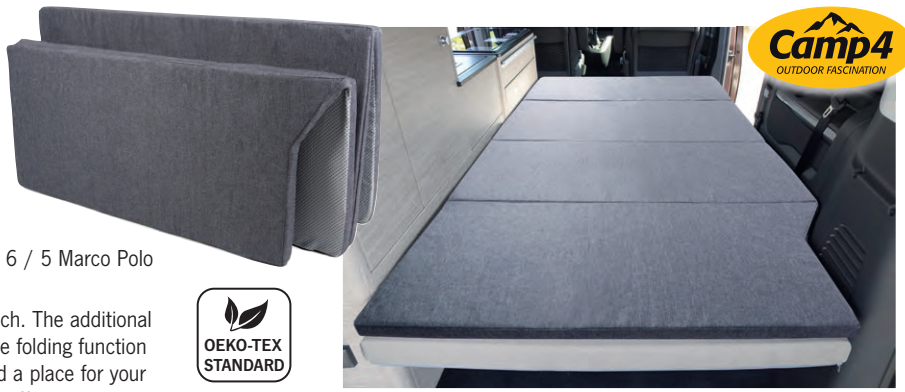

Picture shows topper in Pössl Campster

<b>Foldable topper for Volkswagen Transporter 6 / 5, California Beach, Multivan KR, with 3-seater seatbench YOC &lt;23</b>	59013	159,-
<b>Comfort wedge for Volkswagen T6/T5 (for 59013)</b>	590130	64,95
<b>Foldable topper Marco Polo Horizon / Activity</b>	59014	159,-
<b>Foldable topper Marco Polo (w/ furniture line)</b>	59015	169,-
<b>Foldable topper Pössl Campster</b>	59016	169,-



Comfort wedge for VW T5/T6



**Gel foam mattress topper**

- Protects mattress, offers high sleeping comfort
- Memory foam perfectly adapts to the shape of the body and returns to its original state after pressure is relieved
- Soft memory foam with integrated gel particles for temperature regulation
- Perfect for traveling and at home



The anti-slip effect and elastic bands on the bottom fix the topper on the mattress for a secure fit. Easy to roll up with 2 rubber bands.

Material: outer cover 100% jaquard fabric (removable and washable up to 40°C). Filling: 45D memory foam with incorporated blue gel particles. Certified according to OEKO-TEX Standard 100. (Note: after opening and unrolling, let rest until fully unfolded)

<b>Topper L195 x W80 x H4cm, weight 3,1kg</b>	59031	59,95
<b>Topper L195 x W120 x H4cm, weight 4,8kg</b>	59032	79,95



**Gel head cushion with memory foam**

- Cooling gel pad on one side
- Memory foam on the other side
- Memory foam adapts to the shape of the body
- Removable, washable cover



The pillow ensures a relaxed sleep. Reversible function: The cooling gel pad (45x27cm) for the summer months on one side, memory foam on the other. Material: outer cover 100% poly-mesh fabric, filling: memory foam 850g + 360g gel (certified to OEKO-TEX Standard 100)

Dimensions: L60 x W40 x H12cm, weight: 1.3kg. Transport bag included. 59030 22,60

**Patented cabin crib system for cabin swivel seats**

- For additional sleeping places in cabin
- Lying surface: approx. 160-174 x 55cm (depending on vehicle model)
- Load capacity up to max. 70kg per bed
- Easy assembly & disassembly in under 1 minute
- Robust, double-walled telescopic aluminum rod
- Robust and abrasion resistant nylon fabric
- Compact pack size when not in use & storage
- Weight: single bed 3.5kg, double bed 7kg
- Washable up to 30 °C



Attachment by hanging on the headrests

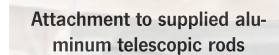

Attachment to supplied aluminum telescopic rods



Mounting kit included  
Storage bag included

**Cabbunk** Patented  
Add TWO extra child beds to your campervan.



	e.g. for VW Caddy, VW T4/T5/T6, VW Multivan, VW ID Buzz, Mercedes Viano/Vito/Metris, Ford V710, Ford Transit Custom, Renault Trafic		VW Transporter w/ double seat*		Ford Transit < 2014		Renault Master/ Opel Movano < 21		Mercedes-Benz Sprinter, VW Crafter, Fiat Ducato, Peugeot Boxer, Ford Transit(> 2015)		Triple seat all vehicles	
<b>Single bed</b>	42193	305,-	42188	245,-	42197	305,-	42195	305,-	42191	305,-	—	—
<b>Double bed</b>	42194	539,-	—	—	42198	539,-	42196	539,-	42192	539,-	42199	539,-

\*Order mounting kit 42180



**froli**

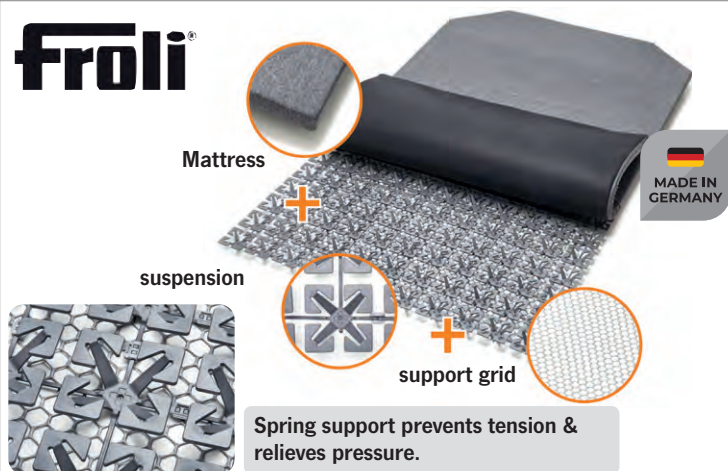

**Retrofit sleeping set  
for Volkswagen Transporter 6 / 5 California**

- Sleeping set consists of mattress, slat base & support grid
- Higher sleeping comfort due to comfort slatted base
- Quality mattress w/ 48 kg /cbm density
- Has a pressure-relieving effect & prevents tension
- Mattress cover: upper side made of double cloth, bottom side made of breathable Airmesh fabric, washable at 30°C

The slatted frame in your vehicle serves as the base for the new bed system and does not need to be removed. Simply remove the old mattress, unroll the support grid and the slat base, attach, put the new mattress on it. Ready! The support grid prevents the springs from slipping through the slatted frame. The spring mat provides pressure-relieving support. This can prevent tension and one-sided strain. The open, air-permeable cells provide perfect ventilation and an ideal sleeping climate. Total height only 7cm. High quality PUR cold foam core mattress, firmness level: medium firm. Scope of delivery: 1 support grid, 1 spring mat (height 3cm), 1 mattress (thickness 4cm), 25 Velcro connectors, weight: 10.9kg. **93083 619,-**

Spring support prevents tension & relieves pressure.



Scan QR code and watch product video

**DIY Travelfix Camper -  
the bed kit for DIYers**

- Complete bed kit for DIYers
- Delivery includes 44 comfortable spring elements
- Maximum bed size: 70x200cm

The set contains all the components needed to make a slatted frame with spring elements.

Scope of delivery: 44 spring elements, 22 slat mounts, 11 curved spring slats, mounting material, mounting instructions and mounting video.



Scan QR code and watch product video

**930122 244,-**

**Accessories:**

Stabilization	E6847	19,20
Plastic runner/strap guide for lifting bed	E5433	13,95

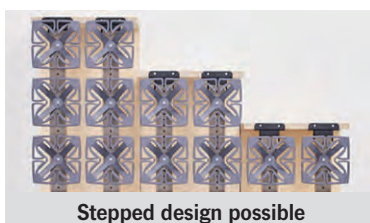
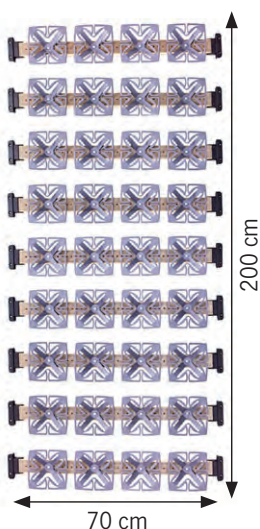

Stepped design possible



High quality suspension elements

**Sleep padding for Ford Nugget**

- For lower sleeping area of following models: Ford Nugget, Nugget Plus, Nugget Active and Nugget Trail
- Breathable, ventilated underside thanks to air mesh
- Cover is removable (zipper) & washable at 30 °C
- Easy to stow in the vehicle, dust protection w/ duffel bag

The ideal fit, high-quality appearance and workmanship adapt perfectly to your vehicle. Unfolded in a few seconds, the lower sleeping area of the Ford Nugget motorhome (not for Big Nugget XL (LR)) becomes a comfortable place to sleep. Material polyester cover, top + sides: double fabric, unquilted, underside: Air-Mesh fabric. Dimensions: approx. H 4.5 x L 90 x W 102/124cm, pack size: approx. L 102 x Ø 40cm

Weight: approx. 5.6kg with duffel bag, volume weight 40kg/m³, compression hardness: 4.0kPa. **590245 439,-**



**CARBEST**

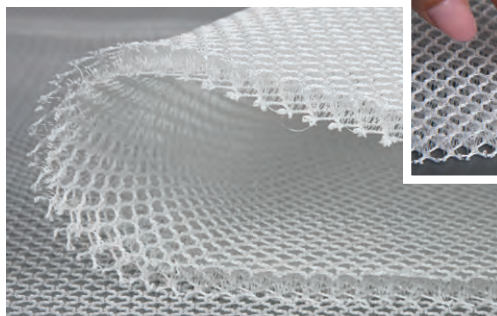

**Mattress padding**

- Avoids condensation
- Highly elastic PE thread fabric
- Provides good air conditioning under mattress

The pressure-elastic and breathable fabric made of PE threads acts like an invisible climate zone. The mattress base provides pressure relief and the support of the intervertebral disc. Can be individually cut to size. Available in thicknesses of 10 and 15mm.

W 80 x L 200 x H 1.0 cm	93936	39,95
W 120 x L 200 x H 1.0cm	93938	64,95
W 140 x L 200 x H 1.0cm	93939	89,95
W 80 x L 200 x H 1.5cm	939360	59,95
W 120 x L 200 x H 1.5cm	939380	89,95
W 140 x L 200 x H 1.5cm	939390	119,95



# Dreams come true in the smallest space

Froli sleep systems promote healthy sleep while saving an enormous amount of space and weight. The degree of hardness can be increased in various areas if desired, e.g. for lumbar support, by subsequently clipping in tensioning crosses. The support is a standard mattress, preferably cold foam or latex.



- In a handy **basic package** is a complete kit for the standard dimensions of berths in touring vehicles.
- Froli **extension package** adds missing elements in case of deviations from standard dimensions.



Description	Star ①	Travel ②	Scor ③	Zona ④
Feature	Allrounder	Ultra flat	Triple adjustable lumbar area	Particularly strong
Description	High cushioning provides optimum pressure relief. Ensures healthy ventilation and prevents moisture in the mattress.	Ideal for space problems, low ceilings, slopes, curves and angles. Well suited for boats, alcoves and special dimensions.	Ideal ventilation thanks to innovative ventilation slats. Triple adjustable lumbar area. Ideal pressure distribution.	Ideal for heavy sleepers. High spring deflection ensures maximum comfort. Adapts to the contours of the body in a pleasant way.
Installation height	4,3 cm	3,7 cm	6,0 cm	6,0 cm
Spring deflection	3,3 cm	3,0 cm	4,0 cm	4,0 cm
Firmness zones	3 (with shoulder zone)	3 (with shoulder zone)	2 (with shoulder zone)	4 (with shoulder zone)
<b>Basic package</b>	50 springs normal, 10 springs soft, 60 foot crosses, 10 clamping crosses	40 springs normal, 8 springs soft, 48 foot crosses, 8 clamping crosses	36 normal springs, 8 springs soft, 44 foot crosses, 8 lumbar supports	44 spring head plates, 36 normal springs, 8 springs soft, 44 foot crosses, 8 lumbar inserts
<b>Art. no.</b>	<b>93012</b>	<b>93010</b>	<b>930114</b>	<b>930111</b>
<b>Price</b>	<b>157,-</b>	<b>159,-</b>	<b>165,-</b>	<b>179,-</b>
<b>Extension package</b>	10 springs normal, 2 springs soft, 12 foot crosses, 2 clamping crosses	10 springs normal, 2 springs soft, 12 foot crosses, 2 clamping crosses	9 springs normal, 2 springs soft, 11 star bases, 2 lumbar supports	9 springs normal, 2 soft springs, 11 star bases, 2 lumbar inserts
<b>Art. no.</b>	<b>93013</b>	<b>93011</b>	<b>930115</b>	<b>930112</b>
<b>Price</b>	<b>42,50</b>	<b>46,95</b>	<b>51,-</b>	<b>55,-</b>
<b>Extension package</b>	<b>Soft:</b> 12soft springs, 12 foot crosses	<b>Half elements:</b> 12 half elements and 12 foot crosses	<b>Lumbar support:</b> 10pieces	<b>Lumbar support:</b> 10pieces
<b>Art. no.</b>	<b>930120</b>	<b>930100</b>	<b>930116</b>	<b>930113</b>
<b>Price</b>	<b>42,95</b>	<b>43,95</b>	<b>12,-</b>	<b>15,-</b>
<b>Package of clamping crosses</b>	Set of 15 pieces	Set of 15 pieces		
<b>Art. no.</b>	<b>930121</b>	<b>930101</b>		
<b>Price</b>	<b>17,-</b>	<b>16,50</b>		

### Froli head adjustment ultra light

Height adjustable in 6 steps. Stable due to honeycomb structure, ventilation prevents condensation. Head adjustment already mounted, ultra-light, approx. 1.6kg. Environmentally friendly packaging. Dimensions: 70 x 43 x 4 cm



**59017 42,40**

### Froli head adjustment retrofittable

The Froli retrofit head adjustment can be fitted in a few simple steps and attached to the lower surface of the bed. Width 80cm. The width can be individually adjusted by shortening the slats.



**59021 49,95**



# SAFETY NETS / ELECTRIC LIFTING BED

## Protective nets to secure people or luggage

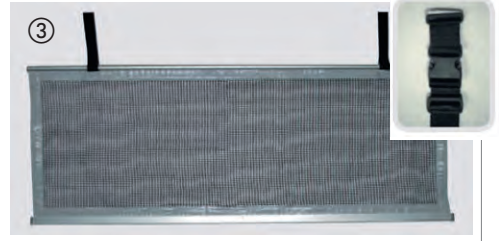
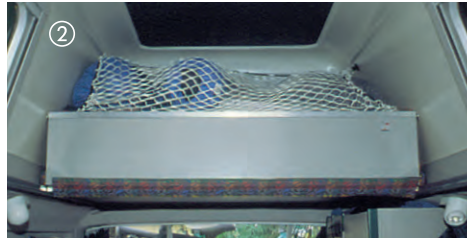

① **Alcoves - protective nets, TÜV approved.**  
 Fall protection for high roofs and alcove beds.  
 Protection for objects and sleeping children.  
 Attached to the roof with wide strap and special hook at the top; securely held with 4 latches at the bottom. **106 x 35 cm 46187 106,-**

② **Safety nets (not for personal safety !)**  
 Securing luggage. Elastic and tear resistant.  
 Can be shortened, incl. 4 fastening eyelets. Net height approx. 60cm. 100% polyester.  
**Width 80-120 cm 46184 18,95**  
**Width 100-140cm 46182 17,80**  
**Width 140-180cm 46183 19,95**  
**Width 200cm 46185 20,95**

③ **Safety nets (not for personal safety!)**  
 For securing luggage in the alcove.  
**150 x 58 cm 461770 70,95**  
**180 x 58 cm 461760 73,95**



## Sliiper fall out protection incl. fastening strap

Important safety for your children is the fall-out protection in 4 model widths. Sufficient uniform height of 50cm meets the requirements of DIN 1645 and 1646. Finger protection for the smallest and maximum visibility for children and parents is guaranteed. 8 variable attachment points can be freely selected. Delivery incl. assembly material. Suitable for children from 18 months, max. permissible weight of child 22.5kg

Width 70cm	47523	56,90
Width 100cm	47524	65,90
Width 150cm	47525	75,90
Width 190cm	47526	99,90

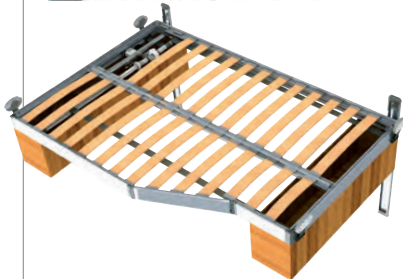

2 mounting options:  
 Height adjustment of the rear bed or lifting bed above kitchenette or driver's seat

## Electric lifting bed MODULAR SMART BED

- Powerful gear motor
- Heavy-duty steel and aluminum construction
- Manual operation for emergency
- Load capacity: 400kg (static)
- Maximum customization flexibility
- Patented device

With this system, the bed frame can be raised and lowered over the rear garage and over the kitchenette, as well as in the front area. The device is controlled by an electronic, programmed control unit up to 5 levels (ProBed and TopLine) or by an electromechanical control unit (E-Line).

Unlimited running, technically advanced gearmotor with mechanical resistance with integrated encoder. Belt anchoring to brackets provided for this purpose with wall mounting.

Maximum flexibility during assembly. Supplied complete with installation wiring. Movable load: max. 60 kg (increase possible). Load capacity: 400kg static. Power supply 12-20A Operating speed: approx. 60 mm/sec. Dimensions: 1865 x 1500mm. (Design can be changed as desired) Must be measured by your dealer before installation. Instructions for correct dimensioning can be found at [www.reimo.com](http://www.reimo.com)

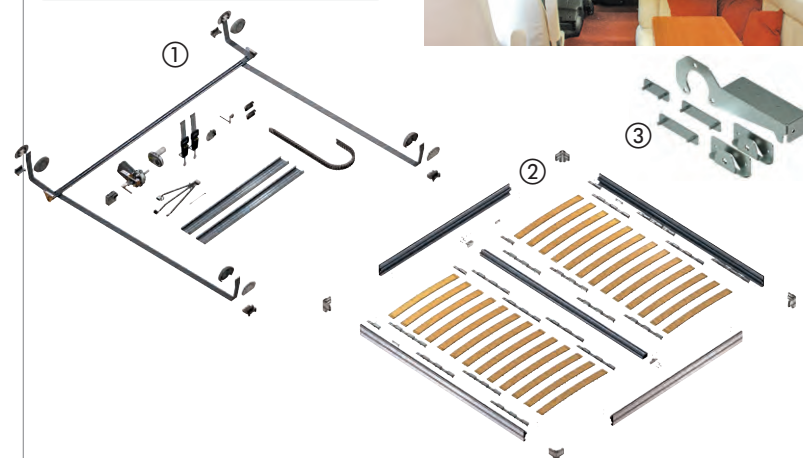

- ① **Lifting system with motor unit** (without bed frame and slatted frame), scope of delivery: motor unit, stabilizing rails, shafts, mounting plates and 4 m long straps. Weight: 8.6kg.  
**93951 1199,-**
- ② **Matching bed frame w/ slatted frame**  
 Can be cut to size, weight app. 15kg **93954 849,-**
- ③ **Assembly kit**  
 (for connecting lifting system (1) & bed frame (2))  
**93955 129,-**

**i** Please contact your specialist dealer to order your dream bed w/ frame including slatted frame, motor unit & belts.





**Electric lifting beds for Fiat Ducato, Peugeot Boxer, Citroën Jumper & Mercedes-Benz Sprinter**

- Complete set
- Space saving sleeping option
- Extra light alu profiles (weight app. 35kg)
- Loadable up to max. 400kg
- Max. 6-7 amps, operational consumption 12V
- No adjustment necessary, lengths compensate themselves independently
- Infinitely height adjustable
- Mechanism under slatted frame integrated in frame
- Maintenance-free
- Slatted frame w/ slat caps, minimizes noise while driving

The new electric lifting bed from Carbest is characterized by its high-quality craftsmanship and intuitive assembly. It is infinitely height-adjustable. The extra lightweight (approx. 35kg) is achieved using sturdy aluminum profiles. The static load capacity is 400kg. The operating speed is 33mm/second, with a consumption of only 7A, input 12V. The maximum stroke (barrel) is 900mm. The product is maintenance-free. Including slatted caps for the slatted frame for optimum reduction of mechanical noise while driving.

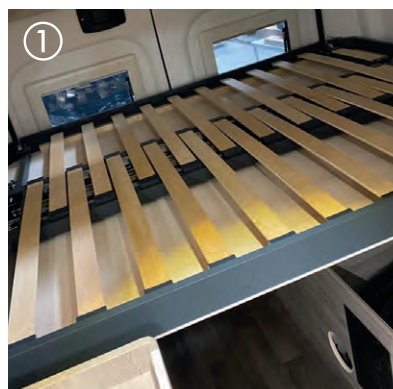

**① For Fiat Ducato, Peugeot Boxer, Citroen Jumper >2015**

**Scope of delivery:**

- 1 drop-down bed 1755 x 1325mm
- 1 mattress 1755 x 1325mm
- 1 trolley right, 1 trolley left
- 2 front bed attachments, 2 bed rails
- 1 fixing point at the rear left
- 1 fixing point at the rear right
- 2 front mounting plates
- 1 electrical component (motor)

**Lifting bed with cable hoist**      1760x1325 mm  
**Frame color black**      93957      1599,-

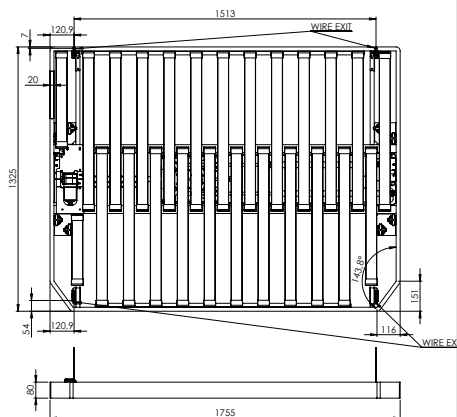
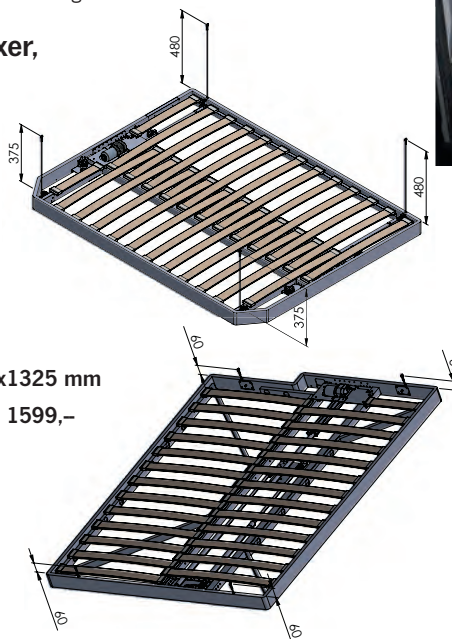

**② For Mercedes-Benz Sprinter**

- 1 drop-down bed 1853 x 1400mm
- 1 mattress 1853 x 1400mm
- 1 trolley right, 1 trolley left
- 1 front bed attachment on the left
- 1 front bed attachment on the right,
- 2 bed rails
- 1 fixing point rear left, 1 fixing point rear right
- 1 fixing plate front right, 1 fixing plate front left
- 1 electrical component (motor)

**Lifting bed with rails**      1853/1761x1400 mm  
 93958      1919,-

**Accessories:**

- Stabilization**      E6847      19,20
- Plastic runner/strap guide for lifting bed**      E5433      13,95

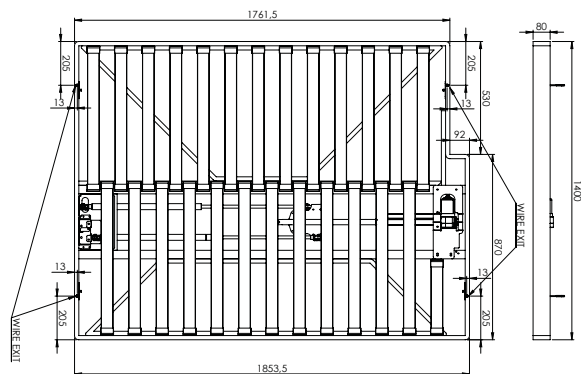

**MANILA - Manual lifting bed**

- Designed for raising and/or lowering in the rear garage, above the kitchenette or driver's seat
- Powerful zero gravity gas struts
- The lifting system fits completely under the bed frame and offers maximum flexibility during assembly
- Robust, lightweight aluminum frame with wooden slats
- Quick, easy installation without wiring
- Includes bed frame and lifting system
- With wall mounting

W 1865 x L 1420mm      93959      1154,-

