



SEATS, BENCHES, BELTS



Swivel console for Ford Transit Custom V710 >10/2023

Swivel console

Driver's side	59680	299,-
Passenger side	59681	299,-

Note: Test certificate expected to be available from February 2025

299,-

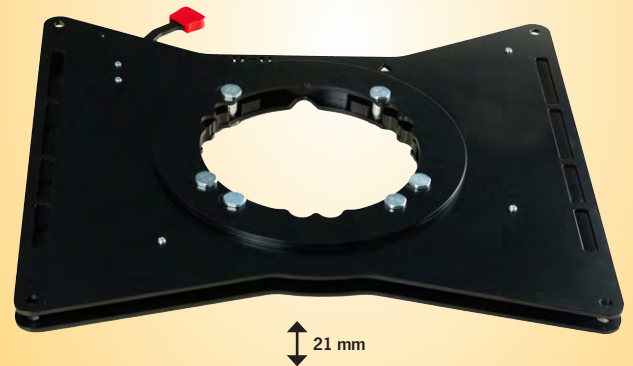

Additional sofa/bench for driver's cab for FIAT Ducato, Mercedes-Benz Sprinter, Ford Transit, MAN TGE, Volkswagen Crafter

Transform your front seats into a comfortable sofa landscape in just a few simple steps. The sofa bench is mounted on the reversed front seats (swivel consoles required). The additional seating area provides space for guests. The velour fabric is velvety soft and easy to remove and wash.

Dims.: width 162 cm, backrest height 50 cm, depth 60 cm, seat/backrest cushion thickness 5 cm Weight: 8 kg

grey	59125	499,-
beige	59124	499,-

499,-

NEW



Harness brackets and Smart Kits.....	678 – 679	Seating/sleeping bench systems	683 – 684
Accessories Smart Kits, Easy bed.....	680	Cab seats	685
3-point seat belt support/double seat bench.....	681	Safety belts	686
Pilot seat.....	682	Swivel plates.....	687 – 691
		Seat covers	692 – 693

Smart Kit: Universal seatbelt supports for 2 people

Belt supports are each positioned on longitudinal member of vehicle; in longitudinal direction, the position is variable. The attachment is made by means of screw connections through the vehicle floor. Weight of the belt stand without fastening parts is between 12.5 and 13.5 kg.

Each kit contains an upper belt rack with pre-assembled seat belts, floor anchoring brackets, a screw set for fastening to the chassis and installation instructions.

Each Smart Kit also contains a type approval.

Type 2: Combi Ready belt support

Double belt support in direction of travel with curved brace in the middle. Specially developed to install a Truma Combi heater on the strut.

i The Truma Combi can be found on page 941.

from 699,-

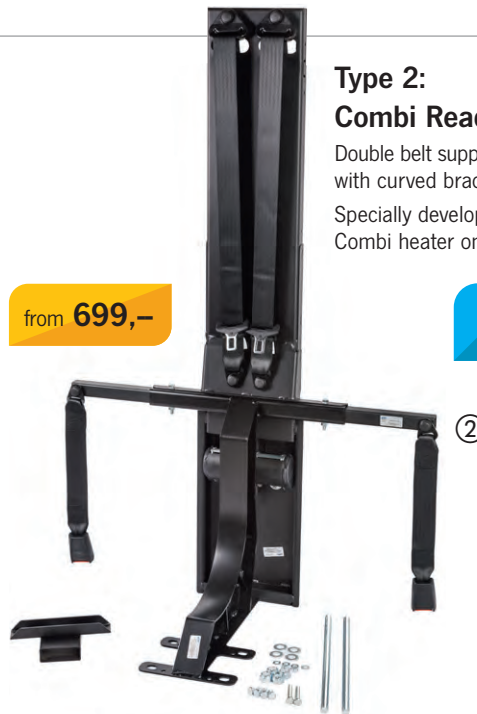

Type 1: Standard belt support

Double belt support in direction of travel w/ straight strut in the middle. One of the lightest solutions on the market, offering sufficient storage space for luggage or installation of electronic accessories.

from 583,-

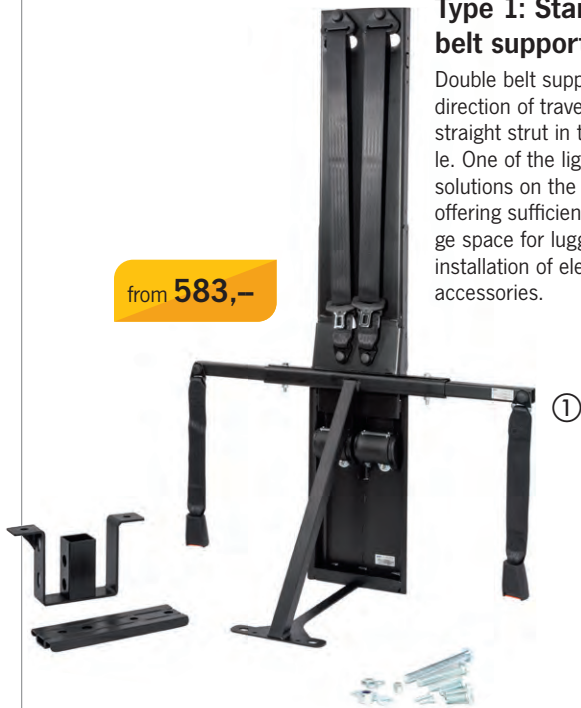

Vehicle-specific installation accessories included in scope of delivery. Accessory sets may vary depending on vehicle type.



Type 3: Off-axis belt support

Double belt support in direction of travel w/ straight strut in a slightly offset position. One of the lightest solutions on the market, offering sufficient storage space for luggage or the installation of electronic accessories on the side.

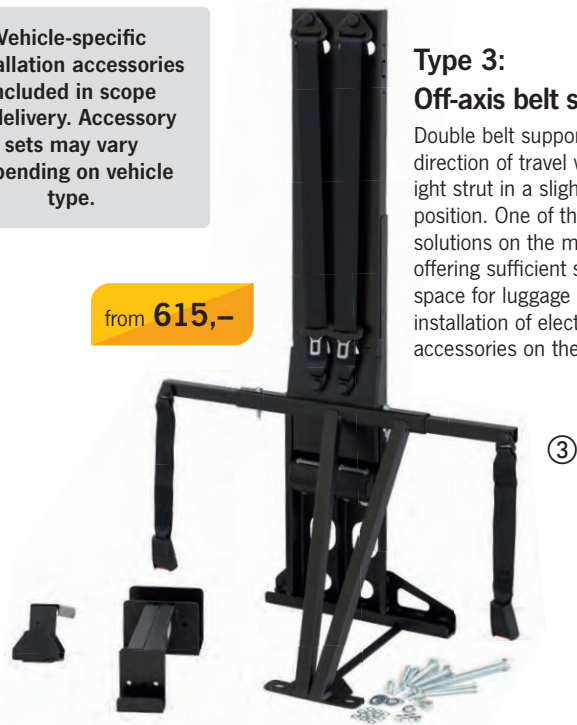
from 615,-



FORD TRANSIT AND FORD SKELETAL >2014

Chassis	Wheelbase (cm)	Seat belt height (mm)	Combi ready	Fig.	Item no.	Price
 FORD TRANSIT VAN	3750	1114,5	off-axis	③	59105	882,-
		1116,5	✓	②	59123	970,-
		1264,5	off-axis	③	59106	899,-
 FORD SKELETAL	3300-3750-3954	1149,5	×	①	59137	990,-

i Tested acc. to ECE R14.06/07. TÜV approval according to §21 (individual approval) is required. Suitable for vehicles registered as special motorhomes. Prior clarification of the mounting situation in the vehicle with the TÜV is recommended.

All components of FORD TRANSIT and FORD SKELETAL Smart Kit are approved in accordance with applicable regulations.

FIAT DUCATO, CITROËN JUMPER, PEUGEOT BOXER >2006, OPEL MOVANO >2021, TOYOTA PROACE MAX >2024

i Tested acc. to ECE R14.06/07.
TÜV approval according to §21 (individual approval) is required. Suitable for vehicles registered as special motorhomes.
Prior clarification of the mounting situation in the vehicle with the TÜV is recommended.

Chassis type	Wheelbase (cm)	Seat belt height (mm)	Combi ready	Fig.	Item no.	Price
STANDARD	3000-3450-3800-4035	1116,5	×	①	59102	597,-
		1199,5	×	①	59515	583,-
		1265	✓	②	59122	819,-
SPECIAL	3000-3450-3800-4035	1116,5	✓	②	59127	825,-
		1199,5	×	①	59103	608,-
		1265	✓	②	59126	815,-
VAN	4035	1116,5	✓	②	59132	699,-
		1199,5	×	①	59128	849,-
	3450-4035	1264,5	off-axis	③	59101	615,-
	4035	1265	✓	②	59131	979,-

All components of FIAT DUCATO Smart Kit are approved in accordance with applicable regulations.

RENAULT MASTER >2011

Chassis type	Wheelbase (cm)	Seat belt height (mm)	Combi ready	Fig.	Item no.	Price
STANDARD	3182-3682-4332	1116,5	×	①	59135	690,-
		1199,5	×	①	59134	675,-
VAN	3182-3682-4332	1264,5	off-axis	③	59107	889,-

All components of RENAULT MASTER Smart Kit are type-tested in accordance with applicable regulations.

IVECO DAILY >2014

Chassis type	Wheelbase (cm)	Seat belt height (mm)	Combi ready	Fig.	Item no.	Price
IVECO DAILY	3000-3450-3800-4035	1116,5	×	①	595014	969,-
		1199,5	✓	②	595016	1111,-
		1199,5	×	①	595013	949,-
		1265	✓	②	595015	1110,-

All components of IVECO DAILY Smart Kit are type-tested in accordance with applicable regulations.

VOLKSWAGEN CRAFTER, MAN TGE >2016

Chassis type	Wheelbase (cm)	Seat belt height (mm)	Combi ready	Fig.	Item no.	Price
VW CRAFTER	3640-4490	1114,5	off-axis	③	59111	679,-
		1264,5	off-axis	③	59136	789,-

All components of VOLKSWAGEN CRAFTER Smart Kit are approved in accordance with applicable regulations.

Matching accessories for universal seatbelt supports

- ① **Headrest kit** Scope of delivery: Headrest pairs on frame incl. padding, axle spacing 158 mm
595008 299,-
- ② **Headrest** Scope of delivery: Single foam headrest on the wall, plastic cover, center distance 50 mm
595023 99,-
- ③ **Isofix bracket** For off-axis harness brackets
59536 156,-
 For standard or Combi Ready harness brackets
59531 142,-
- ④ **Belt frame support, frame reinforcement**
 Depth: Min. 446.25 / Max. 601.25 mm Width: Min. 430 / Max. 762 mm Height: Min 331.5 / Max. 521.5
59138 149,-



496,-



Opened

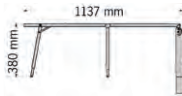
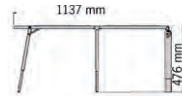
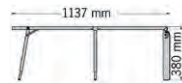

Closed

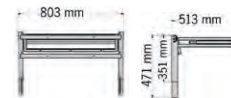

Fold-out Easy Beds for motorhomes, panel vans and minivans

- Compatible with Truma Combi
- Height adjustable
- No approval required

Easy Bed is an additional folding bed for quick installation in your vehicle. Easy Bed is simply anchored to the wooden base of the seat bench with a net made of light and resistant material and thus remains independent of the belt support. With the new telescopic legs, Easy Bed is suitable for panel vans and motorhomes with double floors as well as minivans. Upholstery set not incl. in scope of delivery.

① **Universal add. fold-down bed for motorhomes**

Tech. data: Overall width 803 mm, depth when folded out 1137 mm, depth when folded up 513 mm, bed height when folded out min. 380 / max. 476 mm, minimum height when folded up 351 mm, weight 9.8 kg.

59664 496,-

② **Folding bed especially for panel vans**

Tech data: Overall width 803 mm, depth when folded out 390 - 475 mm, depth when folded up 492 mm, bed height when folded out min. 380 / max. 456 mm, minimum height when folded up 351 mm, weight 4.8 kg.

59682 389,-

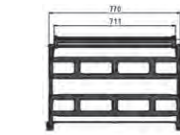

Article 1-6
Compatible with
belt brackets from
page 678 and 679.

NEW



NEW



Upholstery sets for Smart Bed & Smart Seat

Smart Bed cushion sets can be folded out to form a mattress in addition to their function as a seat cushion. You can choose between a continuous headrest cover and a 2-part headrest cover.

Smart Seat upholstery sets cannot be folded out. This is purely a cushion set for sitting. Here too, there is a continuous headrest cover or a 2-piece headrest cover.

All cushion sets are compatible with all Smart Kits and Easybeds

Upholstery sets for Smart Bed

③ Can be extended to form a mattress with a 2-piece headrest cover

59705 649,-

④ Can be extended to form a mattress with a standard headrest cover

59706 689,-

Upholstery sets for Smart Seat

⑤ Seat cushion (non-extendable) with full-length headrest cover

59708 599,-

⑥ Seat cushion (non-extendable) with 2-piece headrest cover

59707 610,-

NEW



NEW



Universal belt support for flex. installation

Modular belt trestle for 2 persons with integrated three-point belts and Isofix mounts, expandable with tested headrests. For better seating comfort, the backrest can be mounted at a slight angle. An elevation kit is included for vehicles with a height difference to the cab or platform.

The belt buck is installed in the vehicle by means of three aluminum rails and can therefore be easily removed again if necessary. The aluminum rails are glued to the vehicle floor and additionally bolted at the rear. Elevation kit and installation kit are incl. in scope of delivery.

An ECE R14.07 (seat belt anchorages), ECE R17 (seat strength) and ECE R16 test certificate is included. It documents the test in the Ford Transit and refers to the fact that the tests can be transferred to other vehicles. ("the results are representative also for other types of vehicles").

We recommend prior clarification of the installation situation with responsible TÜV.

① **3-point belt trestle 900 mm, steel, with adjustable backrest in 3 positions**

Scope of delivery: Seat belt support, 2 three-point seat belts, Isofix brackets, backrest with bracket for headrests, elevation kit for add. 120 mm height, installation kit with 3x aluminum profiles (length 1250 mm each), fastening material for profiles & adhesive

595020 1890,--

② **Seat cushion, supplied with cover and headrests**

595005 598,--

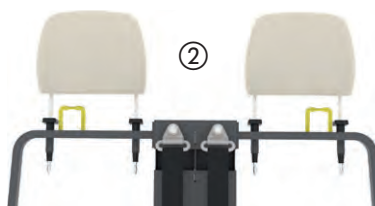

Suitable for vehicles registered as passenger cars or special motorhomes.

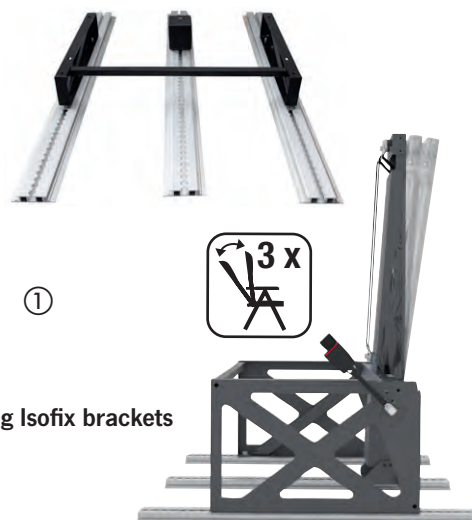

Including Isofix brackets

Tested acc. to motor-home standard

Belt buck for Ducato, Boxer, Jumper

- For retrofitting in the motorhome
- Installation for Fiat Ducato, Peugeot Boxer, Citroën Jumper
- With automatic 3-point harnesses (suitable for child seats)
- Belts are guided concealed in the column, no twisting possible
- Self-supporting design without cross braces preserves storage space in storage box
- Tested according to applicable EC directives on rigid plate
- The existing bench will continue to be used, installation must be registered
- With expert opinion for M1 motorhomes: acceptance acc. to § 21 necessary.

• Attachment to the vehicle floor: mounting kit not included. (Please clarify installation with your local TÜV)

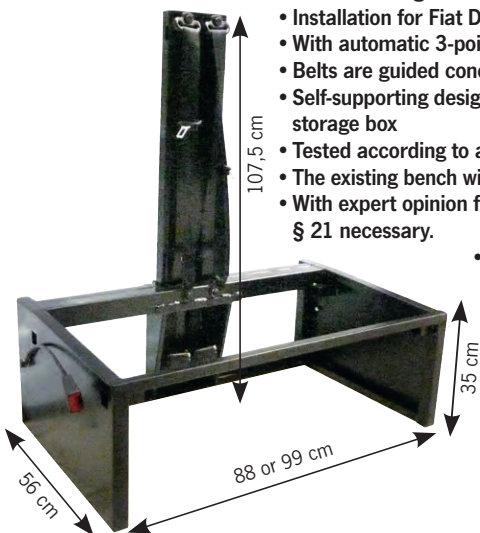

Dims.: W 99 x D 56 x H 107.5 cm, seat height without support: 35 cm, Weight app. 42 kg
59560 1092,--

Dims.: W 88 x D 56 x H 107.5 cm, seat height w/o. support: 35 cm. Weight app. 40 kg
59561 1092,--

Tested on the rigid plate according to regulation 76/115 status 96/38 and 2005/41. Acceptance according to § 21 (indiv. acc.).

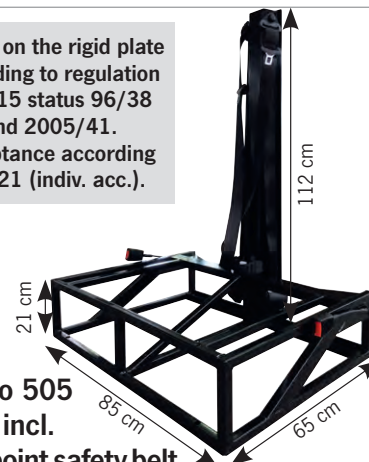

Divano 505 base, incl. 2 x 3 point safety belt

For floor fixing, 5 pieces of hexagon bolts M12 UNI5739 are recommended. Seat height without support: 21 cm, Weight app. 28.6 kg

592360 789,--

Universal double bench

- Fully tested according to ECE requirements for M1 and N1 vehicles
- Double bench with comfortable single seats
- Integrated 3-point safety belts
- Side adjustment for additional clearance of 110 mm during the ride
- Longitudinal adjustment & adjustable backrest for more passenger comfort
- Two piece frame with storage space
- ISOFIX anchorages
- Lower base for vehicles without double bottom

For vehicles without double bottom. The individually adjustable seats are mounted on guides that allow both lateral and longitudinal adjustment for greater comfort while driving. The seat belts are integrated into the backrests. The product is fully tested according to ECE requirements for M1 and N1 vehicles. Armrest optionally available.

Double bench 59258 3254,--
Armrest 59259 168,--





Pilot seat for passenger compartment

- With integrated 3-point safety belts
- Different seat heights can be realized
- Adjustable backrest, armrests and headrests
- Backrest folds forward for easy access
- With M1 classification, suitable for installation in cars or motorhomes
- Meets the current standards for safety valid >1.11.2014 ECE14, ECE17

Euro seat A 400 with 2 armrests

(without seat runners)

Belt left, Grey 59372 1199,-

Belt right, gray 59371 1199,-

Seat bases in different heights incl. floor rail adaptation for 59379 (you need 2 pieces: 1 right and 1 left base per seat):

Seat skid height 23 cm (seat height 41 cm)

left 59366 138,-

right 59365 138,-

Seat skid height 28 cm (seat height 46 cm)

left 59368 138,-

right 59367 138,-

Seat skid height 33 cm (seat height 51 cm)

left 59370 143,-

right 59369 143,-

Vario 3000 seat base for mounting seat A 400 on REIMO floor glide rail Grizzly.

incl. base lock 58194 431,-

Slide rail double row for fixing above seats or several seats in a row. Approx. 1 meter seat rail is required per seat

Length 2,40 m 59379 376,-

Länge 3,00 m 593791 459,-

Special adhesive for bonding the floor rail to the body. Required are at least . 2 cartridges per meter of rail length.

Cartridge 600 ml 593795 28,95

Installation tested for: Volkswagen Transporter 5 Mercedes-Benz Sprinter, VW Crafter, Ducato/Jumper/Boxer, Ford Transit up to 2014



① Rotating double bench

- With integrated 3-point safety belt for the middle seat
- Adjustable backrest
- Belt tensioner right, suitable for Ducato X250 airbag system
- Rotary fitting
- Isofix anchorage for the middle seat
- M1-approved acc. to CE regulations R14 & R17 for installation in DUCATO X250 cab

Model 650, Cover Black/Grey 59252 3362,-

② Rotatable single seat

- Adjustable backrest
- Belt tensioner suitable for Ducato X250 airbag system
- Swivel console and seat tilt adjustment
- M1-approved acc. to CE regulations R14 & R17 for installation in DUCATO X250 cab

Model 610, Cover Black/Grey 59254 1888,-



Standard seat cover in black / gray



Aguti S2 sleeper bench with integrated headrest G2000

- Angle ergonomically adjusted in sitting position
 - Integrated seat belts per seat
 - High quality molded foams with lateral support incl. Isofix holder
 - Individually adjustable backrest
 - Adaptation to original Vito/V-Class/PSA rail systems by means of adapter (optionally available)
 - The entire bench can be moved in the rails or is completely removable
 - Each seat can be folded down individually
- When folded, the lying surface is completely flat
 - The belt buckles dive under the lying surface

A bench seat that can be converted into a sleeping bench in just a few simple steps.

Lying surface: Length 1.86 m incl. leg rest, without leg rest length 1.26 m, width per seat 0.5 m

Color seat covers anthracite patterned
59656 2790,-



2790,-

Seat integrated into seat belt, which can be converted into a sleeping bench by simply folding the back.



You can find further bench seat systems in our catalog DER AUSBAU PROFI



Aguti adapter for S2 sleeper bench

Suitable for original PSA rail system 59658 699,-
Suitable for original Mercedes-Benz rail system 59659 534,-



Aguti leg rest for sleep bench S2

Covered right and left. **Dimensions:** (L x W) 60 cm x 50 cm

59657 879,-





Bench seat/sleeper 540

- Height-adjustable headrests with two adjustment options
- Integrated 3-point safety harness
- Adjustable backrest position
- Bed length 1900 mm
- Width 1200 mm
- Removable rear bed pad
- Ergonomic upholstery, flat bed for better comfort
- Single seat can be folded down independently of double seat
- With ISOFIX

Tested acc. to ECE-R14.
ECE-R17 in progress.
Expected for Q2/2024

Suitable for: Fiat Ducato 250, Citroën Jumper, Ford Transit Custom, MAN TGE, Mercedes-Benz Sprinter, Peugeot Boxer, All approved vehicles for the seat/sleeper bench 540 can be found at reimo.com

Equipment: High quality high density foam. High quality upholstery cover fabric. Sturdy tubular steel frame. The bench seat can be locked in several positions. Total width 120 cm, seat height app. 46 cm. Total height max. 125 cm, total depth app. 88 cm. Sleeping area 120 x 190 cm. **Scope of delivery:** Pre-assembled bench seat, fully upholstered, black/black fabric.

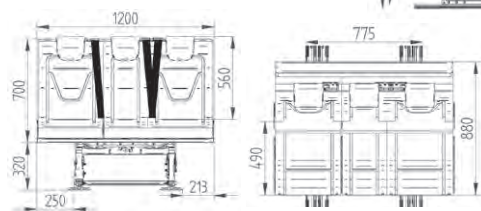

59263 5070,-



Necessary mounting accessories for seat/sleeper bench 540: Installation in the vehicle is carried out using 249 cm long guide rails. These must be ordered separately as a mounting set (item no. 59264). The floor rails are glued to the vehicle floor.

Scope of delivery: Guide rails, incl. mounting adapter for bench seat 540 (item no. 59263) and adhesive.

59264 1690,-

SK7 bench seat system - Extend your sleeping space into the cab

The solution when you want to make full use of space.

Turn the driver or passenger seat, fold out SK 7 bench and you have a comfortable bed with 190 cm length. During the day it is a comfortable seat for 2 people with 2 integrated three-point seat belts. Sleeping surface can be widened to 120 cm by means of a transverse sliding device and additional upholstery. Adjustable tilt of seat and backrest for customized seating comfort.

Suitable for Sprinter, LT, Ducato, Renault and other vehicles.

Fixed bench seat with 2 integrated three-point belts attached to a rigid belt column. The bed is formed from the bench, With transverse sliding device for bed widening up to 1.20 m. TÜV confirmation for motorhome registration is supplied by manufacturer.

Tech. information SK7: Installation in vehicle on base plate (with / without insulation). If base plate is insulated, it must be underlaid with wood in the area of the belt crossbar.

Dims.: seat width 950 mm, seat height app. 590 mm. Total height app. 1250 mm. Total depth app. 900 mm. Sleeping surface app. 960 x 1880 mm. Widening by approx. 200 mm possible. Plinth height app. 210 mm (can be used as storage space).

Scope of delivery: Pre-assembled bench on mounting bracket, ready padded with foam and covers, incl. 2 three-point belts. With transverse sliding device for bed widening up to 1200 mm (w/o. additional padding). Cushion gray

Left-hand drive 59240 3557,-

Additional cushion for SK7 bench system (59240) to cover the Bed widening 59241 319,-

Motorhome homologation acc. to StVZO 76/115/ECE
Manufacturer, Status 2005/41/EC



3557,-

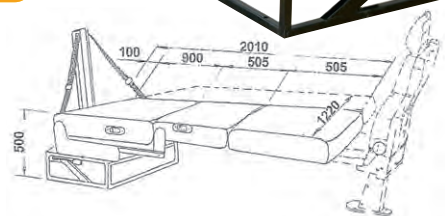

Divano 506 bench

- Please note: Installation in vehicles must be approved by TÜV. We therefore recommend that you consult your local TÜV office before installation.

Motorhome homologation acc. to StVZO 76/115/ECE
Manufacturer, Status 2005/41/EC

Divano bench 506 is equipped with seat belt tether and 2 three-point automatic seat belts. Can be moved forwards and sideways (sideways movement 27 cm, forwards 17 cm).

Equipment: High quality high density foam. High quality upholstery cover fabric. sturdy tubular steel frame. Seat width app. 90 cm, seat height app. 48 cm. Total height app. 129 cm, total depth app. 63 cm. Widening (approx. 27 cm) possible. Plinth height about 20 cm useable as storage space.

Scope of delivery Pre-assembled bench with foam and covers, ready upholstered. With shifting device to the front and to the side.

Divano 506 with two integrated 3-point safety belts.

Operating lever right 59236 2719,-
Operating lever left 592361 2665,-



Pilot seat S 5.1

- Integrated headrest
- The classic

Dims.: Height 92 cm, backrest height 82 cm, seat width with armrests 62 cm, seat depth 52 cm

Pilot seat S 6.1

- With height and tilt adjustable headrest

Dimensions: Height (incl. headrest) 96-106 cm, backrest height (incl. headrest) 79-90 cm, seat width with armrests 62 cm, seat depth 52 cm

Pilot seat S 8.1

- Distinctive side guides and soft foam parts
- Backrest quick adjustment
- Height adjustable armrests
- With height and tilt adjustable headrest

Dimensions: Height (incl. headrest) 94-105 cm, backrest height (incl. headrest) 79-90 cm, seat width with armrests 62 cm, seat depth 53 cm

Pilot seat S 9.1

- Integrated headrest
- Distinctive side guides and soft foam parts
- The comfort seat
- Backrest quick adjustment
- Height adjustable armrests

Backrest height & headrest according to new EC standard.
Dimensions: Height 92 cm, backrest height 82 cm, seat width with armrests 62 cm, seat depth 53 cm.

Pilot seat S 10.1

- Armrests integrated into backrest - creating a larger passage into the living area with maximum seat width
- Quick adjustment of the backrest in segments of >2°
- With seat tilt adjustment in front
- Integrated headrest



Attention:

Sportscraft seats may be used in Germany for motorhomes and passenger cars if there is no seat recognition in the vehicle. Outside Germany, use must be clarified with the regional TÜV.

Model	app. weight	Color Tavoc 2 Grey / Black		Color Macaw Black/ Grey		Color Atlantic Blue	
Pilot seat S 5.1	17 kg	592054	599,-	592055	599,-	592053	598,-
Pilot seat S 6.1	18 kg	592103	696,-				
Pilot seat S 8.1	18 kg	592131	699,-	592132	699,-		
Pilot seat S 9.1	18 kg	592145	633,-	592146	633,-	592144	633,-
Pilot seat S 10.1 Driver's side	18 kg	594054	997,-	594056	997,-		
Pilot seat S 10.1 Passenger side	18 kg	594055	997,-	594057	997,-		

Accessories for Sportscraft van seats

- Seat heating 59165 245,-
- Lumbar support 591651 35,95

Please order with new order, as not retrofittable.

Relax Seat System - Electrically extendable footrest

- Specially designed for panel vans to use the space in front of the passenger seat and increase comfort
- Quick assembly without disassembly of cabin seat
- Low weight

To be used only with the original cabin seats and only with the vehicle in park position.

Mounts under the original seat without having to remove it. Compatibility with produced seat of the Fiat Ducato X250 YOC. 2006 to 2019 and the Fiat Ducato X 290 My. 2014 to 2019.

Certified in R14 in compatibility with CTA turntable P/N 9PG0023000V01 for Fiat Ducato.

Certified in R17 in compatibility with FIAT DUCATO / CITROËN JUMPER / PEUGEOT BOXER seats and CTA / FIAT / AGUTI and swivel plates with a maximum weight of 15 kg.

Scope of delivery: Relax Seat System with electrically extendable footrest for passenger seat, mounting kit and Wi-Fi remote control

59649 579,-



SAFETY BELTS FOR CAMPERS AND MOTORHOMES

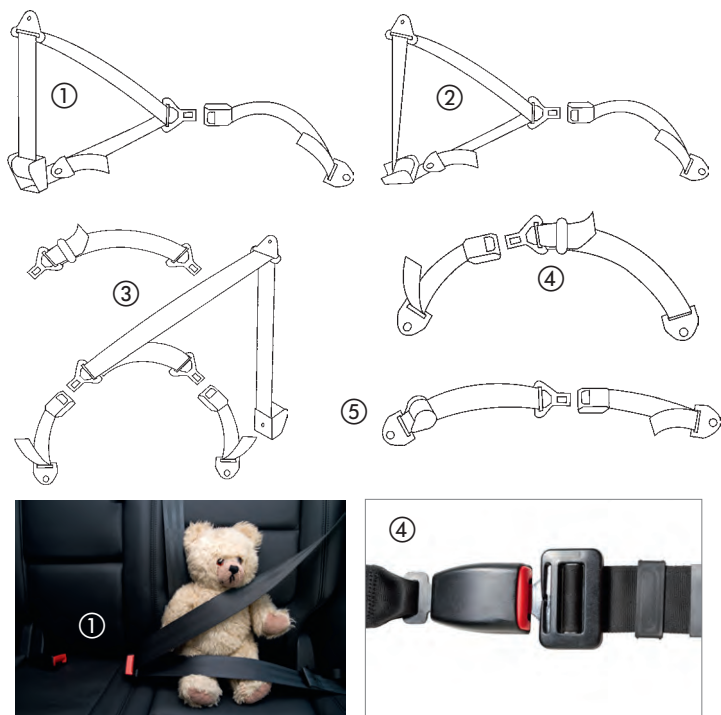

- ① **3-point automatic safety belt, universal use.**
Belt length 4 m, can be shortened. Lock belt adjustable from approx. 35 - 60 cm. Incl. Mounting screws and small parts **58151 61,80**
- ② **3-point automatic safety belt for Variotech benches 3000 Automatic belt, if the belt roller must be mounted vertically.**
Belt length 4 m, lock belt app. 20 cm. Incl. Mounting screws and small parts **58118 57,70**
- ③ **3-point Special safety belt. If a row of furniture is mounted between the upper belt point and the seat.**
Belt length 3.6 m. 2 belt whips adjustable in length, approx. 30 - 60 cm. Incl. longitudinally adjustable lap belt adapter. Necessary if the 3-point belt cannot be used in a driving position. Incl. Mounting screws and small parts **58150 94,90**
As ③, but with belt roller to be mounted horizontally for retrofitting the 3rd belt. Safety belt e.g. family benches T5 **58149 107,-**
- ④ **Lap belt extra-long for the middle seat for passenger car registration, for vehicles first registered before 2005; or for motorhome registration, 2 x per bench (outer seats) if 3-point belts cannot be used on the outside (e.g. in panel vans).** Belt length 150 cm with adjustable lock belt from 30 - 60 cm **58152 30,50**
- ⑤ **Automatic pool belt with adjustable lock belt**
Belt length 150 cm, lock belt from 30 - 60 cm **58153 47,90**

Accessories seat belts

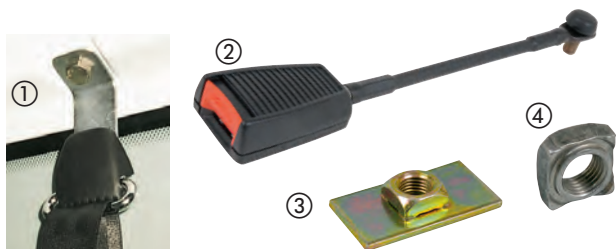

- ① **Belt suspension** For mounting the seat belt in the center above the rear window. Standard, cranked for VW T4 **58050 18,95**
straight, VW T5 **58051 18,95**
- ② **Seat belt whip for S-seats Volkswagen Transporter 4** (driver or passenger side) Required for retrofitting swivel consoles in the VW T4. Length: 310 mm **58046 27,95**
- ③ **Threaded plate 60 x 30 mm**, to weld threads for seat belts at points provided by the vehicle manufacturer. **58052 6,90**
- ④ **Weld-in nut with fine thread** **58045 3,50**

Seat belt adaptors for Volkswagen Transporter 5 panel van >YOC. 3/06

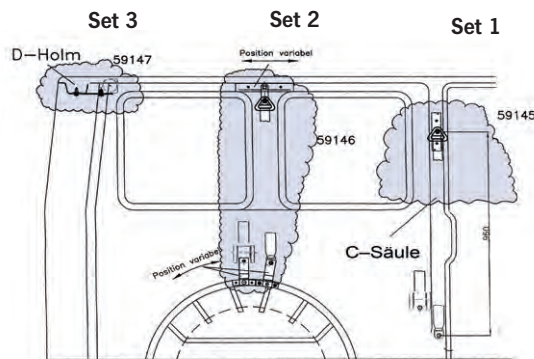

- For 3-point harness
 - For retrofitting the belt anchorage points on the VW T5 panel van
 - Suitable for short and long wheelbase
 - Delivery without straps, suitable for 1 side
- Set 1:** on the C-pillar left or right **59145 39,70**
Set 2: above the rear wheel arch left. or. r. **59146 218,-**
Set 3: at top of D-bar in conjunction with belt 58149 **59147 71,90**



The camper seat "Max"

- Easy installation on the backrest of the cab seat and in the existing vehicle rail
- Convenient alternative to swivel bracket
- No TÜV approval necessary
- Load cap. up to 150 kg
- Regionally developed and produced

The Max camper seat consists of a comfortable padded seat made of certified OekoTex with high quality washable cover and is mounted on 2 stainless steel rails in less than two minutes. The rails are individually adjustable in width and height and suitable for all rail-mounted driver and passenger seats in vans, buses and transporters of various brands. Use only when the vehicle is stationary. Dimensions rail spacing 36,5 - 45.5 cm, rail width 2 cm, height 21 - 26 cm
Light gray/gray 59000 199,-

ROTARY CONSOLES FOR VOLKSWAGEN ID.BUZZ, MULTIVAN, TRANSPORTER 6.1, 6, 5



Attention:

Some swivel consoles require consultation with TÜV to determine whether they may be installed in vehicle. Please discuss this with your TÜV inspector before installation. The TÜV can also accept your vehicle without tested individual components, please clarify details with your test center.



Test acc. to ECE-R14:

Uniform conditions for the approval of vehicles with regard to seat belt anchorages, ISOFIX anchorage systems and anchorages for the ISOFIX top tether



Testing in acc. with ECE-R17:

Uniform provisions concerning the approval of vehicles with regard to the seats, their anchorages and head restraints

Volkswagen ID.Buzz + Volkswagen Transporter 7 Multivan

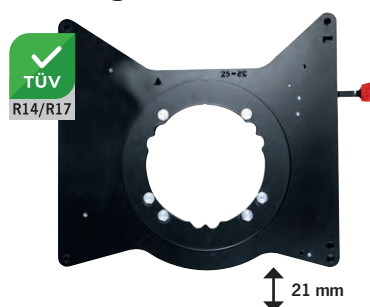

For original seats Volkswagen ID.Buzz and Volkswagen Transporter 7 Multivan

Driver's side 59678 299,-
Passenger side 59679 299,-



Swivel console for VW T7 Multivan
For original Volkswagen Transporter 7 Multivan seats >year 2021 driver and passenger side 59691 499,-

For Volkswagen Transporter 6.1, 6 and 5



For original VW T6.1/T6/T5 seats (individual seats) >2003
Passenger side 595723 278,-

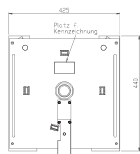

For original seat, driver's and passenger side >YOC. 2003
If original battery is installed.

Matching handbrake lowering necessary for driver's side swivel console
Left-hand drive 59616 39,-
Right-hand drive 596160 39,-

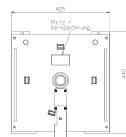

Swivel console >YOC. 2003

Installation only if there is no battery under seat.

Driver's side incl. handbrake lowering.

59498 288,-
Passenger side 59499 259,-

Matching handbrake lowering necessary for driver's side swivel console
59616 39,-



Double swivel console VW T6.1/T6/T5 for original Double seat bench passenger side >YOC. 2003, with cable grommet

Left-hand drive 59695 489,-
Right-hand drive 59696 489,-

For Volkswagen Transporter 6.1, 6 and 5



Seat base for original seat >year 2003
Height adjustable: 230 - 360 mm,
Passenger side 596501 799,-



Adapter Sportscraft seat >YOC. 2003

Incl. Slide rails. For mounting Sportscraft seats on original or swivel brackets.

Driver's side 596451 342,-
Passenger side 596461 342,-



For original seat VOLKSWAGEN TRANSPORTER T5/T6 Bj. 2003-2023

Driver's and passenger side 59699 169,-
Adapter handbrake 59697 41,90



VW T6.1/T6/T5 for original double bench seat >YOC. 2003-2015

With parts certificate. Without cable gland.

Left-hand drive 59496 639,-

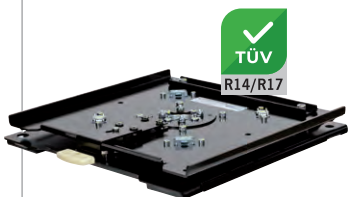

Rotating base for VW T6.1/T6/T5 driver+passenger side with ABE
Mounting also possible on vehicles with battery in seat box. For driver's side, pls. also order handbrake adapter 59616. 59653 275,-

Matching handbrake lowering necessary for driver's side swivel console 59616 39,-



For Volkswagen Transporter 6.1, 6 and 5

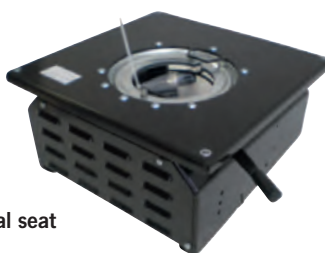

Swivel console for original seat >YOC. 2003

- No increase in seat height
- Rotation of the seat possible even with the door closed
- Also suitable for electrically adjustable seats

With mounting material incl. handbrake lever adapter. TÜV-approved w/ parts certificate.

Locking possible in direction of travel or also in 180° position. Handbrake lever indiv. mountable. External dim.: 430 x 430 x 210 mm. Weight app. 17 kg.

Driver's side 59593 319,-
Passenger side 59594 299,-



Swivel console for VW T6.1/T6/T5
For battery inst.. Height 250 mm
Driver side 59538 539,-
Passenger side 59544 499,-



SWIVEL CONSOLES VOLKSWAGEN/CITROËN/TOYOTA/OPEL

For Volkswagen Transporter 4

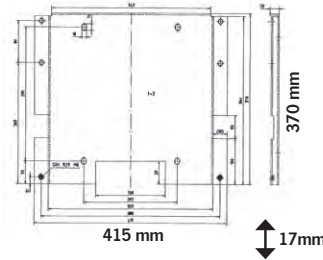
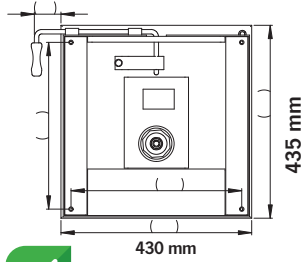

Swivel console for original seat YOC. 1996-2003

Driver's side	59471	196,-
Passenger side	594711	196,-

Swivel bracket original seat + Sportscraft for 1996-2003

Center rotating, with cable entry Driver's side/passenger's side. With ABE.

59501	293,-
-------	-------

Adapter for Sportscraft seat to swivel base 59501.

Original rails required.

59510	169,-
-------	-------

For Volkswagen Transporter 4 to 1996



Rotating console up to YOC.

02/1996 Center rotating for driver/passenger side. Belt whip (No. E5487) must be ordered as well.

59511	309,-
-------	-------

Belt whip for swivel bracket 59511

Screw connection to seat box.

E5487	49,90
-------	-------

For VW Transporter 3 YOC 1979-1992



Swivel base for original seat

For T3 first registration before 1.1.1992 no TÜV required, >1.1.1992 at least a cert. acc. to 76/115 EWG (Europe-wide ECE R14) must be available.

59500	312,-
-------	-------



Adapter for Sportscraft seat

For T3 first registration before 1.1.1992 no TÜV required, >1.1.1992 at least a cert. acc. to 76/115 EWG (Europe-wide ECE R14) must be available.

59503	159,-
-------	-------

For Citroën Jumpy/Peugeot Expert >2016



Swivel bracket for original seat

Driver's side	595881	489,-
Passenger side	595882	419,-
Handbrake cover	595889	18,50



Swivel console for original seat

Driver's side	595883	368,-
Passenger side	595884	372,-
Handbrake lever adapter	595885	46,50

Swivel consoles tested in conjunction with the electrically adjustable seats of:

- Toyota Proace/Proace Verso,
- Citroën Jumpy/SpaceTourer,
- Peugeot Expert/Traveller,
- Opel Vivaro/ Zafira Live
- Low construction
- Large cable gland
- Low weight (approx. 9.4 kg)
- Easy to install
- Tested acc. to M1/N1



Driver's side	59008	328,-
Passenger side	59009	328,-
Handbrake lowering	59010	65,-

For Peugeot Expert/Traveller, Citroën Jumpy/SpaceTourer/Dispatch (UK)/ Toyota ProAce II >2016, Opel Vivaro/Zafira Life/Vauxhall Vivaro (UK) >2019, Fiat Scudo/Ulysse >2022



Flat swivel console for original seat

Driver's side	59668	329,-
Passenger side	59669	329,-
Handbrake adapter	596681	45,90

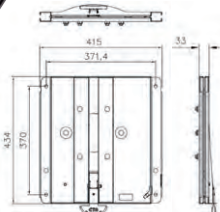

Swivel console w/ elevation for original seat

Driver's side	59670	359,-
Passenger side	59671	359,-
Handbrake adapter	596701	79,95

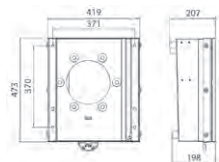

For Ford Transit/ Tourneo Custom V362

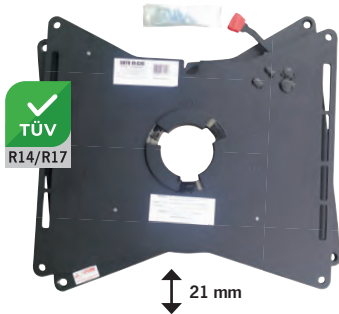

Swivel bracket V362		
Driver's side	59683	312,-
Passenger side	59687	311,-



Handbrake lowering V362 for driver side		
595871		32,60

For original seat Ford Tourneo Custom/Transit Custom V362 >2012-2022 Ford Transit >2014-2023

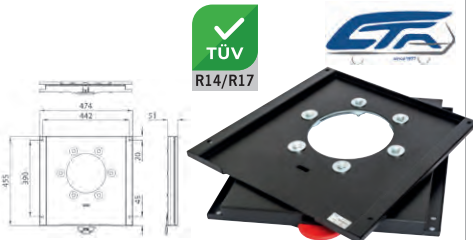

Rotating cons. Driver's side + passenger's side		
59672		249,-

Handbrake adapter for all 3 mod. incl. imitation on leather sleeve

596722		69,90
--------	--	-------

Distance kit only for Ford Transit >2012

596721		49,95
--------	--	-------

For Ford Transit Custom V710 >10/2023



Swivel console		
Driver's side	59680	299,-
Passenger side	59681	299,-

Note: Test certificate expected to be available from February 2025

For Ford Transit

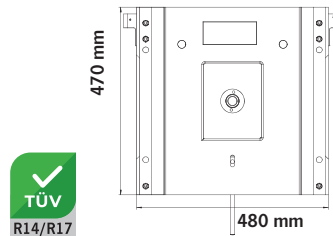

Fig. shows swivel console for driver's side

Swivel console for mounting between original seat box and Ford slide rails, Bj. 2004 - 2012 (Only for vehicles with handbrake left)		
Driver's side	59529	333,-
Passenger side	595291	333,-

For Ford Transit Custom V710 >10/2023



Ford Transit Custom V710 swivel console >10/'23		
Driver's side	59703	279,-
Passenger side	59704	279,-

For Renault Trafic X82/Trafic III, Opel Vivaro >year. 2014 and Fiat Talento

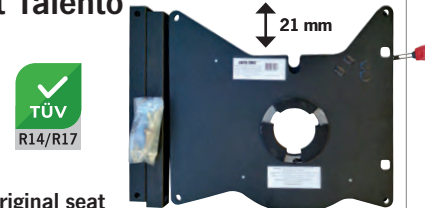

For original seat		
Driver's side	59684	339,-
Passenger side	59683	312,-

For Renault Trafic X82 >2014/ Fiat Talento 2016-2020/ Nissan NV 300 >2016/ Opel Vivaro 2014 - 2019

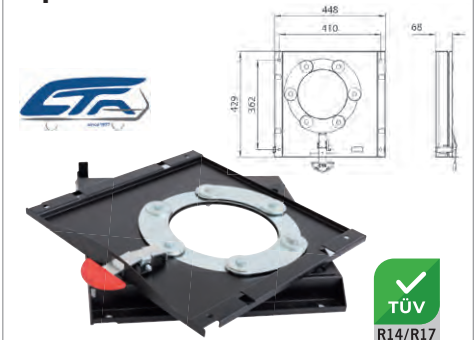

Swivel console for orig. seat		
Driver's side	59673	256,-
Passenger side	59674	249,-

For Renault Trafic II /Opel Vivaro A YOC. 2001 until 2014



For double seat		
594960	704,-	
For original seat		
Driver's side	59570	279,-
Passenger side	595701	279,-

For Renault Master >2010 Opel Movano 2011-2021

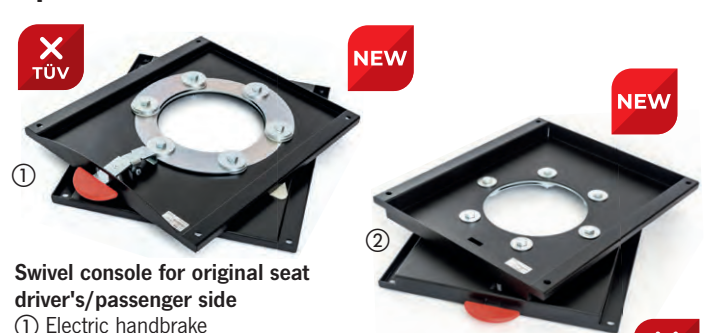

Swivel console for original seat driver's/passenger side

① Electric handbrake	height: 33 mm	59456	269,-
② Manual handbrake, Height: 71 mm		59457	269,-

SWIVEL CONSOLES FOR FIAT/MERCEDES-BENZ/VOLKSWAGEN/RENAULT

For Mercedes-Benz Vito/Viano

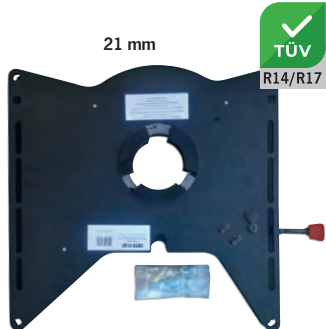
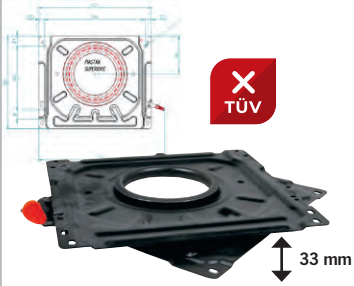

Swivel console for Vito original seat
YOC. 1996 until 2003
 Driver's side 594772 192,-
 Passenger side 594773 192,-

Swivel console for original seat BJ.
2004 until 2015
 Driver's side 59598 311,-
 Passenger side 59599 311,-

Swivel console for original seat
>YOC. 2015 + Sprinter >2019
 Driver's side 59688 311,-
 Passenger side 59686 311,-

For VW Crafter 2017

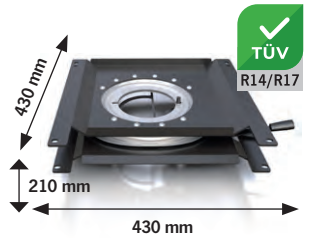

Swivel console for original seat
 ECE-N1 approval
 Driver's side 59692 407,-
 Passenger side 59693 407,-
 Handbrake lever 59694 98,90

For Mercedes-Benz Sprinter and VW LT

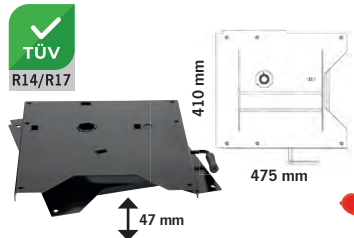

Swivel console for original seat
YOC. 1996 - 2002
 incl. handbrake lowering
 Driver's side 59532 314,-
 Passenger side 59533 314,-

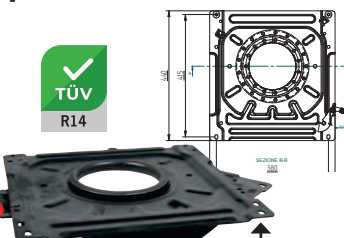

Swivel console for original seat
YOC. 1995 (VW LT 1996) <2006
 Driver's side 59476 240,-
 Passenger side 594761 240,-

For MB Sprinter >2019 and VW Crafter 06-16

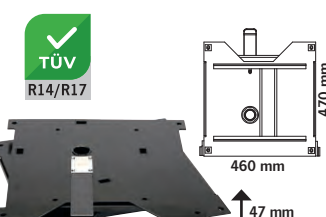

swivel bracket for original seat
 Driver's side incl. handbrake lowering. 59633 317,-
 Passenger side 59634 317,-

For MB Sprinter >2019 and VW Crafter 06-16

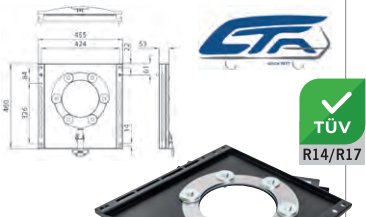

Swivel console for original seat
 For driver or passenger side 59655 239,-

For Volkswagen Crafter/ MAN TGE + 2017 (for VW Crafter YOC. 2017-2021)



For original seats
 Driver's side: 595722 267,-

For Fiat Ducato Type 230 Citroën Jumper Peugeot Boxer

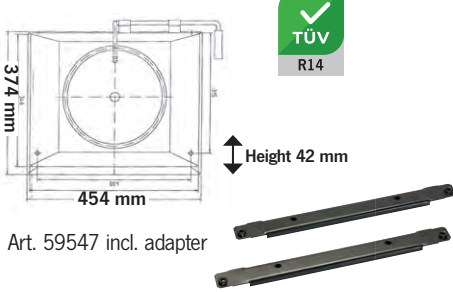

Swivel bracket YOC. 1995-2001 For original driver / passenger seat.
 59546 359,-
 With adapter for Sportscraft seat driver / passenger. 59547 401,-

Universal for Fiat Ducato Mercedes-Benz Sprinter



For Fiat Ducato (and identical models) X250 2006 or X290 2021
 For Mercedes-Benz Sprinter VS30 >2018
 Driver's side 595017 339,-
 Passenger side 595021 339,-
 Mercedes-Benz Sprinter mounting kit VS30 595018 26,50
 Handbrake adapter Mercedes-Benz Sprinter VS 30 596430 55,50
 Mounting kit FIAT Ducato X250 / X290
 driver's side 595019 25,90
 passenger side 595022 8,50

For Renault Master/ Opel Movano

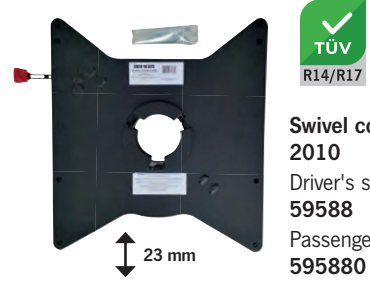

Swivel console >YOC. 2010
 Driver's side 59588 311,-
 Passenger side 595880 311,-

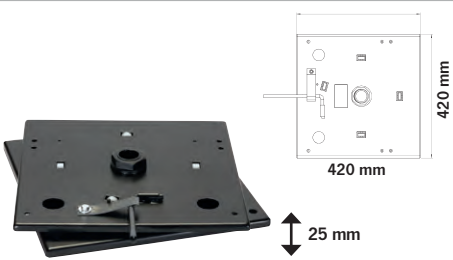

Swivel console for original seat, YOC. 2004-2009,
 Driver/passenger side: 59642 296,-

**For
Fiat Ducato type 244
Citroën Jumper
Peugeot Boxer**

YOC. 2002 - 2006

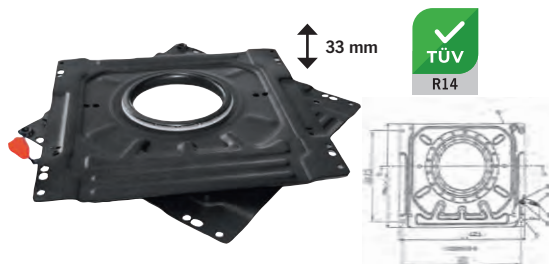

Swivel console for original seat

Driver's side 59478 179,-
Passenger side 594781 179,-



Swivel bracket for original seat Mounting between underframe and slide rail. Off center rotating.

Driver's side 59573 244,-
Passenger side 59574 244,-



Swivel console for original seat
Mounting between base frame and slide rail.
Driver/passenger side, center rotating.

59572 244,-

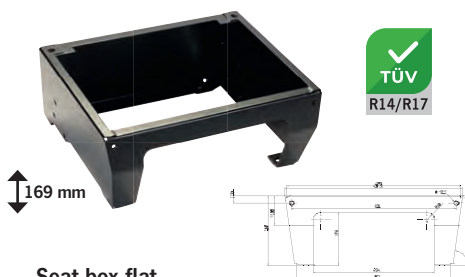

Seat box flat
Instead of original box.

59545 214,-

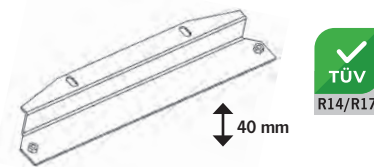

Flat adapter as replacement for original socket
Thus 40 mm lower seating position than with original seat box.

For passenger side 59549 66,-

**For
Fiat Ducato type 250
Fiat Ducato Type 290
Citroën Jumper
Peugeot Boxer**

>YOC. 2006

Opel Movano

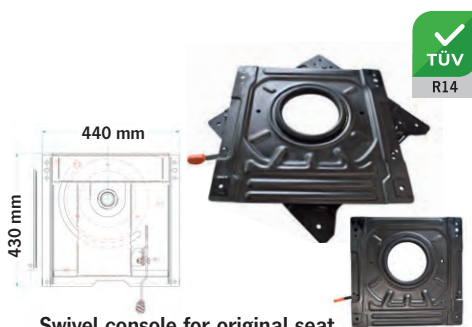

Swivel console for original seat

Driver's side 594722 237,-
Passenger side 594723 237,-

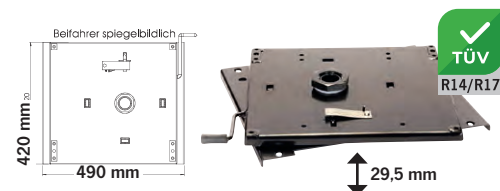

Swivel console for original seat

Driver & passenger side center rotating 59581 279,-
Driver, offset rotating 59583 279,-
Passenger seat, offset rotation 59582 279,-



For Sportscraft seat

Mounting between base frame and slide rail.
Driver's & passenger side center rotating

Driver's side, offset rotating 59589 504,-
E4993 479,-
Passenger side, offset rotation E4863 479,-

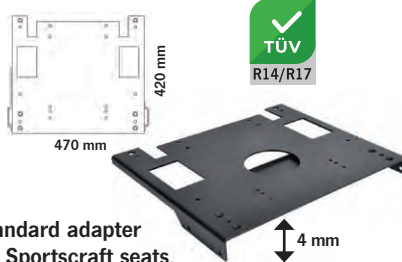

Standard adapter for Sportscraft seats.

59584 225,-

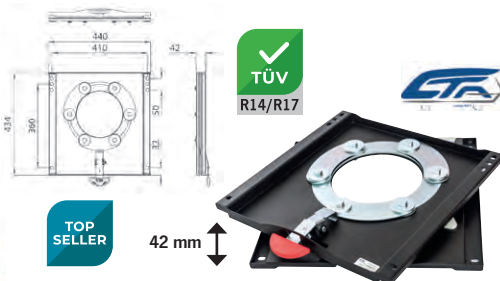

Swivel bracket for original seat driver's and passenger side

For Fiat Ducato X250/X290, Citroën Jumper, Peugeot Boxer >2006, Opel Movano >2022, Toyota Proace Max >Juni 2024 59698 149,-

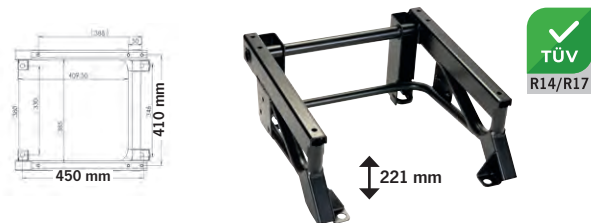

Low seat box

Installation in place of original undercarriage if there is no battery under the seat. Ideal in conjunction w/ swivel bracket. This base is about 40 mm flatter than the original base.

59548 259,-

**For Fiat Ducato type 250X
>YOC. 07/2006**



Swivel console for original seat

Driver's side 594702 185,-
Passenger side 594703 185,-

SEAT COVERS DRIVER AND PASSENGER SIDE



Integral seat cover for Fiat Ducato, Ford seats >2014 and Volkswagen Transporter 6.1 California

- High quality, very elegant design
- Cover imitation leather and microfiber
- For driver and passenger seat
- Zipper on the back pad
- With foam headrest cap



Foam headrest cap

① Faux leather beige/ microfiber grey. 1 pair

Fiat Ducato >2007	943560	235,-
VW T6.1 California >2015 (not shown)	943554	235,-

② Synthetic leather black/ microfiber gray

Fiat Ducato >2014 (no headrest cap)	943561	235,-
VW T6.1 California >2015 (no pic.)	943555	235,-
Ford >2014	943565	209,-

(Scope of delivery: 2 seat covers with integrated headrest, 4 covers for the armrest.



Seat cover for Fiat Ducato

- Premium quality
- Imitation leather, cl. gray-beige
- For driver and passenger seat

Seat cover for Fiat Ducato
>YOC. 2007, with foam headrest cap
943562 119,-

Seat cover for Fiat Ducato
>YOC. 2014 943563 109,-



Protective cover for armrest

>YOC 2007, 1 pair
943564 29,95



For seats with attached headrests

149,90

Terrycloth slipcover

suitable e.g. for Fiat Ducato, Citroën Jumper, Peugeot Boxer and similar vehicle seats. For Hymer, Dethleffs, Carado, Adriatik, TEC, LKC, Hobby, Challenger, Sunlight etc.

Dark blue / gray with headrest and armrests. Set for driver and passenger side. **suitable for Aguti seats**

2 piece 943592 149,90



Cover anthracite/light gray applied to Fiat Ducato standard seat

Beige/sand cover applied to Mercedes-Benz Sprinter Aguti seat

Velour protective covers for cab seats - 2-piece

- Skin-friendly velour cover
- Pleasant seating comfort

Universally fitting protective covers for original vehicle seats, primarily designed for Fiat Ducato and Mercedes-Benz Sprinter. Protects the valuable original upholstery from dirt and wear. Material: Alcatraz faux suede, 100% PL, with FC finish (dirt and stain resistant), washable up to 30°. Not applicable for Ford and Renault Master.

For Fiat Ducato type 250 >2007, type 290 >2014

Cl. anthracite / light gray	943301	119,-
Color Beige/Sand	943307	119,-

Matching slipcover for armrest (1 pair)



For Fiat Ducato >2007

Cl. anthracite / light gray	943305	49,-
Color Beige/Sand	943308	49,-

For Aguti seat Mercedes-Benz Sprinter

Cl. anthracite / light gray	943306	49,-
Color Beige/Sand	943309	49,-



HINDERMANN

Terrycloth slipcover

Simple and inexpensive cover to protect against dirt and wear on your vehicle seat. Simply pull it over the headrest and spread it out over the seat.

Light gray	94357	47,50
Anthracite	94358	47,50

carboset Vario -

Seat heating retrofit kit for one seat

- Stepless control from 0-5 with 10 setting options
- Night design in white
- Low installation depth, very flat design
- Clearly visible due to permanent lighting
- Two-color status display (red/blue for on/off)
- Low power consumption due to electronic control
- Control with thermostat function: heats immediately with 100% power
- Power at each regulator position, then constant temperature depending on selected level

149,-

Scope of delivery for 1 seat:

1x carbomesh Vario 22 (22x50cm) each for seat and backrest, 1 cable set, 1 round switch (5-stage with rotary wheel), installation instructions

59011 149,-



DRIVE DRESSY



Photo shows Dark-grey decor



Photo shows decor Hawaii Dream



Photo shows decor Magic Forest



Photo shows decor Wild Lines

DriveDressy seat covers

- Perfect fit
- Washable
- Stain protection
- Durable/tear-resistant
- Breathable
- Flame retardant
- simple assembly



Scan the QR code and receive YouTube videos on assembly and washing instructions.

Fitgenaue seat covers

for various vehicle models. Every DriveDressy slipcover fits like a second skin. Material specially developed for slipcovers is washable at 30°C, tear-resistant and durable, flame-retardant and breathable. Whether adjusting wheels, ISOFIX or airbag - we pay close attention to the functions your seats have. Easy attachment for any type of seat, which always uses Velcro, hooks or no tools at all.

Unique 3-layer material

Upper layer: robust automotive synthetic fiber

Middle layer: 3 mm foam padding for extra comfort

Bottom layer: Mesh-like protective layer for more slip resistance

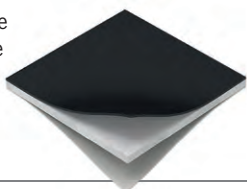

Set driver and passenger

Vehicle type	Armrest covers	Décor				Price
		Dark gray Item no.	Hawaii Dream Item no.	Magic Forest Item no.	Wild Lines Item no.	
Fiat Ducato >14, Citroën Jumper, Peugeot Boxer	4	94379	94380	94381	943791	399,-
Citroën Spacetourer, Pössl Campster/Vanster, Toyota Crosscamp	2 (inside)	94382	94383	94384	943792	399,-
VW T6/6.1 Transporter	4	94385	-	94387	943793	399,-
VW T6/6.1 California (Ocean, Coast, Beach)	4	-	94389	-	943794	399,-
Mercedes-Benz Marco Polo	2 (inside)	-	94392	94393	943795	399,-
Renault Trafic >2015	4	94394	94395	94396	943796	399,-

Rear seat cover

Vehicle type	Headrest covers	Décor				Price
		Dark gray Item no.	Hawaii Dream Item no.	Magic Forest Item no.	Wild Lines Item no.	
Citroën Spacetourer, Pössl Campster/Vanster, Toyota Crosscamp	2	-	-	943841	943797	255,-
VW T6/6.1 California (Ocean, Coast)	2	-	-	-	943798	255,-
VW T6/6.1 California (Beach)	3	-	-	-	943799	275,-
Mercedes-Benz Marco Polo	2	943911	943921	943931	943800	255,-

Active back cushion

- Perfect ventilation and back relief on the go
- For healthy mobility
- Easy to attach due to practical fastening system
- Breathable 3D AirMesh cover with side zipper
- Washable up to 60°

Back cushion with slatted spring core for more ventilation and relief. With built-in back training. Use in all touring vehicles, including seats with side airbags. Also suitable for office chairs. Dims.: L: app. 60 x W: app. 30 cm. Black color.

93009 40,90



Froli

NEW

Additional sofa/bench

for driver's cab for FIAT Ducato, Mercedes-Benz Sprinter, Ford Transit, MAN TGE, VW Crafter

Transform your front seats into a comfortable sofa landscape in just a few simple steps. The sofa bench is mounted on the reversed front seats (swivel consoles required) The additional seating provides space for guests. The velour fabric is velvety soft and easy to remove and wash.

Dims.: width 162 cm, backrest height 50 cm, depth 60 cm, seat/backrest cushion thickness 5 cm Weight: 8 kg

gray 59125 499,-
beige 59124 499,-

