

Seats, benches & belts





SIT COMFORTABLY

ALSO IN THE 2. ROW



Universal double bench

- Fully tested according to ECE requirements for M1 and N1 vehicles
- Double bench with comfortable single seats
- Integrated 3-point safety belts
- Side adjustment for additional clearance of 110 mm during the ride
- Longitudinal adjustment and adjustable backrest for more passenger comfort
- Two piece frame with storage space
- ISOFIX anchorages
- Lower base for vehicles without double bottom

Double bench	59258	3099,-
Armrest	59259	159,90

All information on Page 731

Bench system seat/sleeper bench.....	726 – 728	Slipcovers	734 – 735
Bench underframes / belt trestles.....	729 – 731	Accessories for more seating comfort	736
Safety belts.....	732	Swivel brackets.....	737 – 741
Cab seats / pilot seats.....	739		



1654,-

Bench Divan 502 - comfortable bench

- Seats up to 2 people, because bench width is about 90 cm
- Can also be mounted against the direction of travel
- The inclination of the backrest is adjustable
- Please note: Installation in vehicles must be approved by TÜV. We therefore recommend that you consult your responsible TÜV office before installation.
- Suitable for Sprinter, LT, Ducato, Renault and other vehicles
- Mounting of two lap belts possible

Motorhome homologation according to StVZO 76/115/ECE according to Manufacturer, Booth 96/38/EC

Technical info Divan bench: Divan bench 502 is without seat belts. It can be mounted anywhere where seat belts are not required.

Equipment: High quality high density foam. High quality upholstery cover fabric. Sturdy tubular steel frame. Additional storage space under the seat. The installation can be done on a base plate or directly on the vehicle floor (with or without rubber mat). Seat width ca. 96 cm, seat height ca. 52 cm. Total height about 125 cm, total depth about 90 cm. Sleeping surface ca. 96 x 194 cm. Widening (ca. 30 cm) possible. Plinth height about 21 cm can be used as storage space.

Scope of delivery: Pre-assembled bench with foam and covers, ready upholstered, fabric gray.

Divan 502

Operating lever backrest right	59232	1654,-
Control lever backrest left	59234	1654,-
Wood trim , decor anthracite for seat frame Divan 502	59221	164,90

Can also be used against the direction of travel.



Divano 506 bench

- Please note: Installation in vehicles must be approved by TÜV. We therefore recommend that you consult your responsible TÜV office before installation.

Motorhome homologation according to StVZO 76/115/ECE according to Manufacturer, Status 2005/41/EC

Divano bench 506 is equipped with seat belt tether and 2 three-point automatic seat belts. Forward and lateral displacement possible (lateral displacement 27 cm, forward 17 cm).

Equipment: High quality high density foam. High quality upholstery cover fabric. sturdy tubular steel frame. Seat width ca. 90 cm, seat height ca. 48 cm. Total height ca. 129 cm, total depth ca. 63 cm. Widening (ca. 27 cm) possible. Plinth height about 20 cm can be used as storage space.

Scope of delivery Pre-assembled bench with foam and covers, ready upholstered. With shifting device to the front and to the side.

Divano 506 with two integrated 3-point safety belts.

Operating lever right	59236	2469,-
Operating lever left	592361	2469,-



Seat/sleeper bench

- Cushion foldable to couch
- Bed size: 1870 mm x 1000 mm
- One side armrest
- Adjustment of the backrest by means of slide rails
- Cross rail (lateral displacement) to widen the bed
- Motorhome homologation according to StVZO 76/115/ECE according to manufacturer, status 2005/41/EC

Seat/sleeper bench

with integrated 3-point safety belts

59242 4240,-

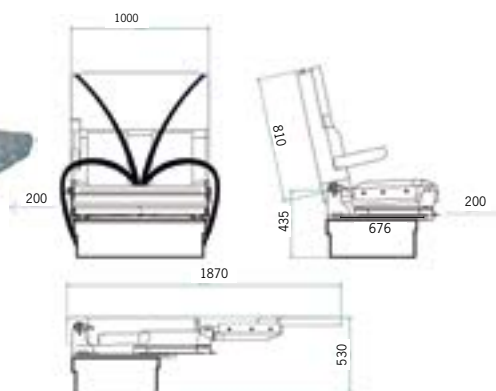

You can find more bench systems in our catalog
Der Ausbau-Profi

① Rotating double bench

- With integrated 3-point safety belt for the middle seat
- Adjustable backrest
- Belt tensioner right, suitable for Ducato X250 airbag system
- Rotary fitting
- Isofix anchorage for the middle seat
- M1-approved according to CE regulations R14 and R17 for installation in the DUCATO X250 cab

Model 650, Cover Black/Grey 59252 3199,-

② Rotatable single seat

- Adjustable backrest
- Belt tensioner suitable for Ducato X250 airbag system
- Swivel console and seat tilt adjustment
- M1-approved according to CE regulations R14 and R17 for installation in the DUCATO X250 cab

Model 610, Cover Black/Grey 59254 1775,-



Standard seat cover in black / gray

SK7 bench seat system - Extend your sleeping space into the cab

The solution when you want to make full use of the space.

Turn the driver or passenger seat, fold out SK 7 bench and you have a comfortable bed with 190 cm length. During the day it is a comfortable seat for 2 people with 2 integrated three-point seat belts. The sleeping surface can be widened to 120 cm by means of a transverse sliding device and additional upholstery. Adjustable tilt of seat and backrest for customized seating comfort.

Suitable for Sprinter, LT, Ducato, Renault and other vehicles.

Fixed bench seat with 2 integrated three-point belts attached to a rigid belt column. The bed is formed from the bench, With transverse sliding device for bed widening up to 1.20m. TÜV confirmation for motorhome registration is supplied by the manufacturer.

Technical info SK 7: Installation in vehicle on base plate (with or without insulation). If the base plate is insulated, it must be underlaid with wood in the area of the belt crossbar.

Dimensions: seat width 950 mm, seat height ca. 590 mm. Total height ca. 1250 mm. Total depth ca. 900 mm. Sleeping surface ca. 960 x 1880 mm. Widening by ca. 200 mm possible. Plinth height ca. 210 mm (can be used as storage space).

Scope of delivery: Pre-assembled bench on mounting bracket, ready padded with foam and covers, incl. 2 three-point belts. With transverse sliding device for bed widening up to 1200 mm (without additional padding). Cushion gray

Left-hand drive 59240 3370,-

Additional cushion for SK7 bench system (59240) to cover the

Bed widening 59241 304,-

Motorhome homologation according to StVZO 76/115/ ECE according to Manufacturer, Status 2005/41/EC



3370,-

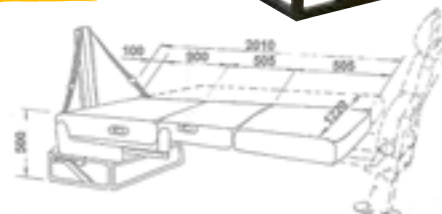

Pilot seat for the passenger compartment

- With integrated 3-point safety belts
- Different seat heights can be realized
- Adjustable backrest, armrests and headrests
- Backrest folds forward for easy access
- With M1 classification, suitable for installation in cars or motorhomes
- Meets the current standards for safety valid from 1.11.2014 ECE14, ECE17



Euro seat A 400 with 2 armrests (without Seat skirts)

Belt left, Grey 59372 1199,-

Belt right, gray 59371 1199,-

Seat bases in different heights incl. floor rail adaptation for 59379

(you need 2 pieces: 1 right and 1 left base per seat):

Seat skid height 23 cm (seat height 41 cm)

left 59366 137,90

right 59365 137,90

Seat skid height 28 cm (seat height 46 cm)

left 59368 137,90

right 59367 137,90

Seat skid height 33 cm (seat height 51 cm)

left 59370 142,90

right 59369 142,90

Vario 3000 seat base for mounting seat A 400 on Reimo floor slide rail Grizzly. incl. base lock 58194 407,-

Slide rail double row for fixing above seats or several seats in a row. Ca. 1 meter seat rail is required per seat Length 2,40 m 59379 376,-

Länge 3,00 m 593791 459,-

Special adhesive for bonding the floor rail to the body. Required are at least . 2 cartridges per meter of rail length. Cartridge 600 ml 593795 28,95



Installation tested for: VW T5, MB Sprinter, VW Crafter, Ducato/Jumper/Boxer, Ford Transit until 2014

SLEEPING BENCH



2790,-



Aguti S2 sleep bench with integrated headrest G2000

Seat integrated into the seat belt, which can be converted into a sleeping bench by simply folding the back.

- Angle ergonomically adjusted in sitting position
- Integrated seat belts per seat
- High quality molded foams with lateral support incl. Isofix holder
- Individually adjustable backrest
- Adaptation to original Vito/V-Class/PSA rail systems by means of adapter (optionally available)
- The entire bench can be moved in the rails or is completely removable
- Each seat can be folded down individually
- When folded, the lying surface is completely flat
- The belt buckles dive under the lying surface

Bench which can be converted into a sleeping bench in just a few steps.
Lying surface: Length 1.86 m incl. leg rest, without leg rest length 1.26 m, width per seat 0.5 m
Color seat covers anthracite patterned 59656 2790,-



You can find further bench systems in catalog The Finishing Professional



Aguti adapter for sleep bench S2

Suitable for original PSA rail system 59658 672,-
 Suitable for original Mercedes rail system 59659 534,-

Aguti leg rest for sleep bench S2

Covered right and left.
Dimensions: (L x W) 60 cm x 50 cm 59657 879,-



Belt trestle for 2 people standard kit

- Optimization of warm air distribution by positioning the combi in the center of the vehicle

The belt support is positioned on the longitudinal member of the vehicle, in the longitudinal direction the position is variable. The attachment is made by means of screw connections through the vehicle floor. The weight of the belt trestle without mounting parts is between 12.5 and 13.5 kg in each case.

Supplied complete with mounting hardware and safety straps.

① **For Citroen Jumper panel van with wheelbase 4.035 m**

Better use of storage space through integration the Truma Combi into the seat bench, inside the Belt Anchorage Structure.

59104 1050,--

② **Belt support Ford Transit Standard Kit**

H=1114,5 mm 59105 832,--

③ **Belt support Ford Transit Standard Kit**

H=1264,5 mm 59106 853,--

Seatbelt Renault Master Standard Kit (without picture)

H=1264,5 mm 59107 919,--



The camper seat "Max"

- Convenient alternative to the swivel bracket
- No TÜV approval necessary
- Load capacity up to 150 kg
- Simple mounting in existing vehicle rails
- Regionally developed and produced



The Max camper seat consists of a comfortable padded seat made of certified OekoTex with high quality washable cover and is mounted on 2 stainless steel rails in less than two minutes. The rails are individually adjustable in width and height and suitable for all rail-mounted driver and passenger seats in vans, buses and transporters of various brands. Use only when the vehicle is stationary.

Dimensions:

Rail spacing 36.5 - 45.5 cm, rail width 2 cm, height 21 - 26 cm

Light gray/gray 59000 199,--



Easy fold out bed

- Compatible with Truma Combi

Easy Bed is an additional folding bed for quick installation in your vehicle. With a net made of light and resistant material, Easy Bed is easily anchored to the wooden base of the bench and thus remains independent of the belt structure. With the new telescopic legs, Easy Bed is suitable for panel vans and motorhomes with raised floors, as well as minivans.

Technical data: Width 724 mm, height 500 mm, total depth 1217 mm, weight 10 kg.

59664 496,--



3 POINT BELT BUCK



Suitable for vehicles with registration as a special motorhome. Tested in the vehicle according to ECE R14.06/07.

529,-

from 544,-

Universal belt trestles for 2 people

Tested in the vehicle (homologation) for FiatDucato/ CitroënJumper/Peugeot Boxer (from 2006), Opel Movano from 2021. Tested in the vehicle according to ECE R14.06/07.

An acceptance at the TÜV according to § 21 (individual acceptance) is necessary. Prior clarification of the mounting situation in the vehicle with the TÜV is recommended.

The belt supports are each positioned on the longitudinal member of the vehicle; in the longitudinal direction, the position is variable. The attachment is made by means of screw connections through the vehicle floor. The weight of the belt trestle without mounting parts is between 12.5 and 13.5 kg in each case. Delivery in each case complete with mounting hardware and safety straps. There are 3 different basic types:

- ① Type 1: For Fiat Ducato X250/X290 panel vans/station wagons: Seatbelt kit normal 59101 529,-
- ② Type 2: For Fiat Ducato X250/X290 chassis with high ladder frame: Belt buck kit normal 59103 565,-
Belt support kit raised (83 mm higher) 59515 544,-
- ③ Type 3: For Fiat Ducato X250/X290 chassis with flat frame: Belt buck kit normal 59102 555,-
Belt support kit increased (83 mm higher) 59516 570,-

Suitable accessories for the universal belt trestles

- ③ Headrest Kit Scope of delivery: 2 curved headrests including mounting plate 595008 299,-
- ④ Isofix holder For normal harness brackets 59536 156,-
For belt blocks with central leg 59531 142,-

Tested according to Motorhome standard

Belt buck for Ducato, Boxer, Jumper

- For retrofitting in the motorhome
- Installation for Fiat Ducato, Peugeot Boxer, Citroën Jumper
- With automatic 3-point harnesses (suitable for child seats)
- Belts are guided concealed in the column, no twisting possible
- Self-supporting design without cross braces preserves the storage space in the storage box
- Tested according to applicable EC directives on rigid plate
- Previous seat continues to be used, installation subject to registration
- With expert opinion for M1 motorhomes: acceptance according to § 21 necessary.
- Fastening to the vehicle floor: Not included in the scope of delivery. (Please clarify installation with your local TÜV)

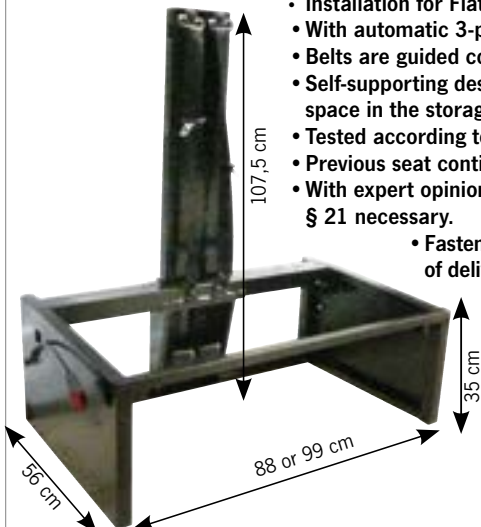

Dimensions: W 99 x D 56 x H 107.5 cm, seat height without support: 35 cm, Weight ca. 4 kg
59560 949,-

Dimensions: W 88 x D 56 x H 107.5 cm, seat height without support: 35 cm. Weight ca. 40 kg
59561 949,-

Tested on the rigid plate according to regulation 76/115 status 96/38 and 2005/41. Acceptance according to § 21 (individual acceptance).

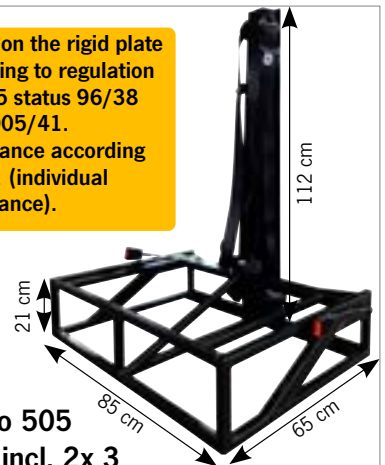

Divano 505 base, incl. 2x 3 point safety belt

For floor fixing, 5 pieces of hexagon bolts M12 UNI5739 are recommended. Seat height without support: 21 cm, Weight ca. 28.6 kg
592360 755,-



Suitable for vehicles registered as passenger cars or special motorhomes.

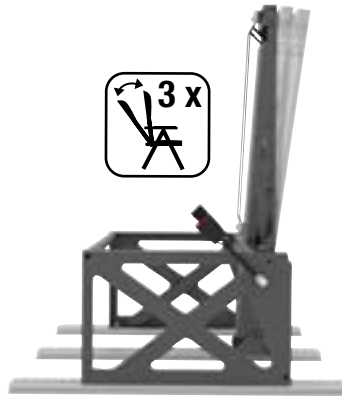

Isofix brackets included



Universal belt buck for flexible installation

Modular belt trestle for 2 persons with integrated three-point belts and Isofix mounts, expandable with tested headrests. For better seating comfort, the backrest can be mounted at a slight angle. An optional elevation kit is available for vehicles with a height jump to the cab or platform.

The belt buck is installed in the vehicle by means of three aluminum rails and can therefore be easily removed again if necessary. The aluminum rails are glued to the vehicle floor and additionally screwed in the rear area.

A test certificate according to ECE R14.07 (seat belt anchorages), ECE R17 (seat strength) and ECE R16 is enclosed.

It documents the test in the Ford Transit and refers to the fact that the tests can be transferred to other vehicles.

We recommend prior clarification of the installation situation with the responsible TÜV.

① 3-point belt trestle 900mm, steel, with adjustable backrest in 3 positions

Scope of delivery: Belt buck, 2 three-point belts, Isofix brackets, backrest with bracket for headrests
595010 1199,-

② Increase kit for additional 120 mm height
595002 111,90

③ Seat cushion, scope of delivery with cover and headrests
595005 569,-

Installation kit consisting of:

3x aluminum profiles length 1250 mm each, fastening material for profiles, adhesive
595006 434,-



2-point belt hanger for VW Crafter and MAN TGE from 2016

Each kit includes a top harness frame with pre-assembled safety harnesses, floor anchoring brackets, a set of bolts to secure to the chassis, and installation instructions. All components of the Volkswagen Crafter Smart Kit are approved in accordance with current regulations. Headrests are also available as an option.

Scope of delivery: 2-point belt trestle incl. anchoring clamps, safety belts and fastening screws
59111 679,-



Suitable accessories for the universal belt trestles

Headrest Kit Scope of delivery: 2 curved headrests including mounting plate

595008 299,-

Universal double bench

- Fully tested according to ECE requirements for M1 and N1 vehicles
- Double bench with comfortable single seats
- Integrated 3-point safety belts
- Side adjustment for additional clearance of 110 mm during the ride
- Longitudinal adjustment and adjustable backrest for more passenger comfort
- Two piece frame with storage space
- ISOFIX anchorages
- Lower base for vehicles without double bottom



For vehicles without double bottom. The individually adjustable seats are mounted on guides that allow both lateral and longitudinal adjustment for greater comfort while driving. The seat belts are integrated into the backrests. The product is fully tested according to ECE requirements for M1 and N1 vehicles. Armrest optionally available.

Double bench 59258 3099,-
Armrest 59259 159,90



Technical dimensions can be found at: www.reimo.com

SAFETY BELTS FOR CAMPERS AND MOTORHOMES

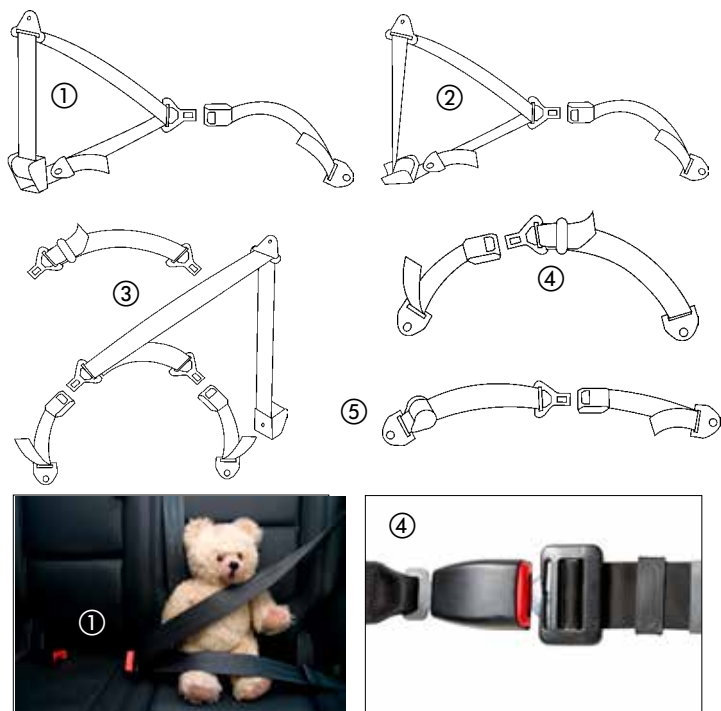

- ① **3-point automatic safety belt, universal use.**
Belt length 4 m, can be shortened. Lock belt adjustable from ca. 35 - 60 cm. Incl. Mounting screws and small parts
58151 60,60
- ② **3-point automatic safety belt for Variotech benches 3000**
Automatic belt, if the belt roller must be mounted vertically.
Belt length 4 m, lock belt ca. 20 cm. Incl. Mounting screws and small parts
58118 55,-
- ③ **3-pointSpecial safety belt. If a row of furniture is mounted between the upper belt point and the seat.**
Belt length 3.6 m. 2 belt whips adjustable in length, ca. 30 - 60 cm. Incl. longitudinally adjustable lap belt adapter. Necessary if the 3-point belt cannot be used in a driving position. Incl. Mounting screws and small parts
58150 92,90
As ③, but with belt roller to be mounted horizontally for retrofitting the 3rd belt. Safety belt e.g. family benches T5
58149 104,50
- ④ **Lap belt extra-long for the middle seat for passenger car registration, for vehicles first registered before 2005; or for motorhome registration, 2 x per bench (outer seats) if 3-point belts cannot be used on the outside (e.g. in panel vans).**
Belt length 150 cm with adjustable lock belt from 30 - 60 cm
58152 29,90
- ⑤ **Automatic pool belt with adjustable lock belt**
Belt length 150 cm, lock belt from 30 - 60 cm
58153 46,90

Accessories seat belts

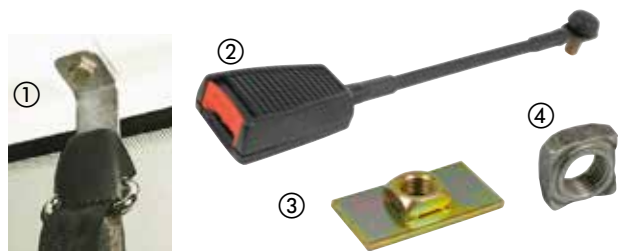

- ① **Belt suspension** For mounting the seat belt centered over the rear window. Standard, cranked for VW T4
58050 17,90
straight, VW T5
58051 17,90
- ② **Belt whip for S-seats VW T4** (driver or passenger side)
Required for subsequent installation of swivel consoles in the VW T4. Length: 310 mm
58046 28,25
- ③ **Threaded plate 60 x 30 mm**, to weld threads for seat belts at points provided by the vehicle manufacturer.
58052 6,40
- ④ **Weld-in nut with fine thread**
58045 2,95

Belt adaptations for VW T5 panel van from My. 3/06

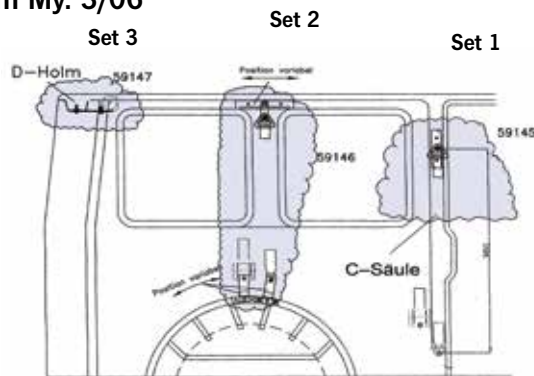

- For 3-point harness
 - For retrofitting the belt anchorage points on the VW T5 panel van
 - Suitable for short and long wheelbase
 - Delivery without straps, suitable for 1 side
- Set 1:** on the C-pillar left or right **59145 37,40**
Set 2: above the rear wheel arch left. or. r. **59146 205,-**
Set 3: at the top of the D-bar in conjunction with belt 58149
59147 67,70





Pilot seat S 5.1

- Integrated headrest
- The classic

Dimensions:

Height 92 cm
backrest height 82 cm
seat width with armrests 62 cm
seat depth 52 cm

Pilot seat S 6.1

- With height and tilt adjustable headrest

Dimensions:

Height (incl. headrest) 96-106 cm
backrest height (incl. headrest) 79-90 cm
seat width with armrests 62cm,
seat depth 52 cm

Pilot seat S 8.1

- Distinctive side guides and soft foam parts
- Backrest quick adjustment
- Height adjustable armrests
- With height and tilt adjustable headrest

Dimensions:

Height (incl. headrest) 94-105 cm
backrest height (incl. headrest) 79-90 cm
seat width with armrests 62 cm
seat depth 53 cm

Pilot seat S 9.1

- Integrated headrest
- Distinctive side guides and soft foam parts
- The comfort seat
- Backrest quick adjustment
- Height adjustable armrests

Backrest height and headrest according to new EC standard.

Dimensions:

Height 92 cm
backrest height 82 cm
seat width with armrests 62 cm
seat depth 53 cm.

Pilot seat S 10.1

- Armrests integrated into backrest - creating a larger passage into the living area with maximum seat width
- Quick adjustment of the backrest in segments of >2°
- With seat tilt adjustment in front
- Integrated headrest



Attention:

Sportscraft seats may be used in Germany for motorhomes and passenger cars if there is no seat recognition in the vehicle. Outside Germany, the use must be clarified with the regional TÜV.

Model	ca. weight	Color Tavoc 2 Grey / Black		Color Ara Black/Grey		Color Atlantic Blue	
Pilot seat S 5.1	17 kg	592054	559,-	592055	559,-	592053	559,-
Pilot seat S 6.1	18 kg	592103	649,-				
Pilot seat S 8.1	18 kg	592131	649,-	592132	649,-		
Pilot seat S 9.1	18 kg	592145	590,-	592146	590,-	592144	590,-
Pilot seat S 10.1 Driver's side	18 kg	594054	1025,-	594056	1025,-		
Pilot seat S 10.1 Passenger side	18 kg	594055	1025,-	594057	1025,-		

Accessories for Sportscraft van seats

- Seat heating 59165 245,-
- Lumbar support 591651 35,95

Please order with new order, as not retrofittable.

Relax Seat System - Electrically extendable footrest

- Specially designed for panel vans to use the space in front of the passenger seat and increase comfort
- Quick assembly without disassembly of the cabin seat
- Low weight

To be used only with the original cabin seats and only with the vehicle in park position.

Mounts under the original seat without having to remove it. Compatibility with produced seat of the Fiat Ducato X250 My. 2006 to 2019 and the Fiat Ducato X 290 My. 2014 to 2019.w.

Certified in R14 in compatibility with CTA turntable P/N 9PG0023000V01 for Fiat Ducato.

Certified in R17 in compatibility with FIAT DUCATO / CITROEN JUMPER/ PEUGEOT BOXER seats and CTA / FIAT / AGUTI and rotating plates with a maximum weight of 15 kg.

Scope of delivery: Relax Seat System with electrically extendable footrest for passenger seat, mounting kit and WI-FI remote control

59649 579,-



SLIPCOVERS DRIVER AND PASSENGER SIDE



CARBEST
INNOVATIONS FOR MOBILE LIFE



Foam headrest cap

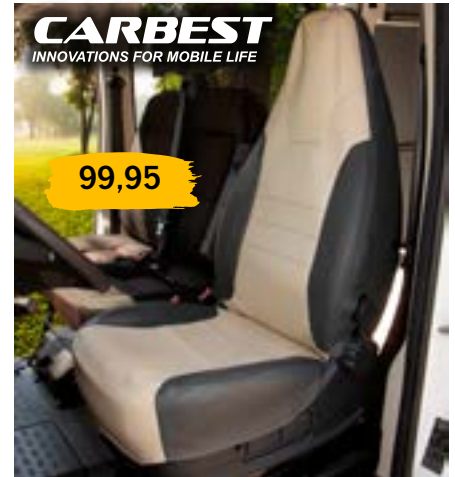

Slipcover for Fiat Ducato

- Premium quality
- Imitation leather, color gray-beige
- For driver and passenger seat

Slipcover for Fiat Ducato from My. 2007, with foam headrest cap

943562 99,95

Slipcover for Fiat Ducato from My. 2014

943563 99,95

Slipcover for armrest

from My. 2007, 1 pair

943564 29,95



Integral slipcover for Fiat Ducato

- High quality, very elegant design
- Cover imitation leather and microfiber
- For driver and passenger seat
- Zipper on the back pad
- With foam headrest cap

① Seat cover "easyfit" Fiat Ducato ab My. 2007

Faux Leather Beige/ Microfiber Gray

per pair 943560 235,-

② For Fiat Ducato from Bj 2014, incl.4x armrest protectors

Imitation leather black/microfiber gray + pads for backrests

per pair 943561 207,-



Slipcover for armrest

Faux leather beige

left 592352 64,60

right 592353 64,60



Cover anthracite/light gray applied to Fiat Ducato standard seat



Cover Beige/Sand applied to Mercedes Sprinter Aguti seat

Velour slipcovers for cab seats - 2 pieces

- Skin friendly velour cover
- Pleasant seating comfort

Universally suitable slipcovers for original vehicle seats, mainly designed for Fiat Ducato and Mercedes Sprinter. Protects the valuable original upholstery from dirt and wear. Material: Alcatraz faux suede, 100% PL, with FC finish (dirt and stain resistant), washable up to 30°. Not applicable for Ford and Renault Master.

For Fiat Ducato type 250 from 2007, type 290 from 2014

Color anthracite / light gray 943301 119,-

Color Beige/Sand 943307 119,-

Matching slipcover for armrest (1 pair)



For Fiat Ducato from 07

Color anthracite/light gray 943305 49,-

Color Beige/Sand 943308 49,-

For Aguti seat Mercedes Sprinter

Color anthracite/light gray 943306 49,-

Color Beige/Sand 943309 49,-

For seats with attached headrests



159,90

Terrycloth slipcover

suitable e.g. for Fiat Ducato, Citroën Jumper, Peugeot Boxer and similar vehicle seats. For Hymer, Dethleffs, Carado, Adriatik, TEC, LKC, Hobby, Challenger, Sunlight etc.

Dark blue / gray with headrest and armrests. Set for driver and passenger side.

2 piece 943591 159,90

suitable for Aguti seats

2 piece 943592 149,90



HINDERMANN

Terrycloth slipcover

Simple and inexpensive cover to protect against dirt and wear on your vehicle seat. Simply pull it over the headrest and spread it out over the seat.

Light gray 94357 47,50

Anthracite 94358 47,50



Dark-grey
Photo shows VW T6

Hawaii Dream
Photo shows Fiat Ducato

Magic Forest
Photo shows VW T6
California Beach

Magic Forest
Photo shows Citroën
Campster

Seat covers

- Perfect fit
- Washable
- Stain protection
- Durable
- Breathable



Fitgenaue seat covers for various vehicle models. Every DriveDressy slipcover fits like a second skin. Material specially developed for slipcovers is washable at 30°C, tear-resistant and durable, flame-retardant and breathable. Whether adjusting wheels, ISOFIX or airbag - we pay close attention to the functions your seats have. Easy attachment for any type of seat, which always uses Velcro, hooks or no tools at all.

Unique 3-layer material

Top layer: Sustainable, durable synthetic fiber made from PET

Middle layer:
3 mm foam padding for extra comfort

Bottom layer:
Mesh-like protective layer for more slip resistance

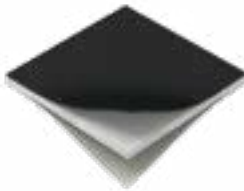

Set driver and passenger					
Vehicle type	Armrest covers	Décor			Price
		Dark-grey Item no.	Hawaii Dream Item no.	Magic Forest Item no.	
Fiat Ducato >14, Citroën Jumper, Peugeot Boxer	4	94379	94380	94381	399,-
Citroën Campster/Vanster, Toyota Crosscamp, Citroën Spacetourer	2 (inside)	94382	94383	94384	399,-
VW T6/6.1 Transporter	4	94385	94386	94387	399,-
VW T6/6.1 California (Ocean, Coast, Beach)	4	94388	94389	94390	399,-
Mercedes Polo	2 (inside)	94391	94392	94393	399,-
Renault Trafic >2015	4	94394	94395	94396	399,-

Rear seat cover					
Vehicle type	Headrest covers	Décor			Price
		Dark-grey Item no.	Hawaii Dream Item no.	Magic Forest Item no.	
Citroën Campster/Vanster, Toyota Crosscamp, Citroën Spacetourer	2	943821	943831	943841	255,-
VW T6/6.1 California (Ocean, Coast)	2	943881	943891	943901	255,-
VW T6/6.1 California (Beach)	3	943882	943892	943902	275,-
Mercedes Polo	2	943911	943921	943931	255,-



Slipcovers for Ford seats from 2014

For all Ford seats from 2014

Scope of delivery: 2 seat covers with integrated headrest, 4 covers for the armrest.

Material: Faux leather / fabric.

Color: Black / Dark gray



943565

209,-

ACCESSORIES FOR MORE SEATING COMFORT

DOMETIC

369,-



MagicComfort MSH 300 - Carbon seat heater

- Easy installation
- Super fast and adjustable heating
- 3 heat settings from 10 to 70 watts
- Cut to size carbon heating elements

Seat inserts with carbon heating for the driver's and passenger's seat, heat up quickly and provide instant warmth. Easy operation by ergonomic push button with LED display.

Input voltage (DC) 12 V, rated input power (DC) 140 W, dimensions: W 270 x H 580 x D 2 mm. Weight: 1.32 kg

4 piece 59006 369,-



149,-

carbaset Vario - seat heating retrofit set for one seat

- Stepless control from 0-5 with 10 setting options
- Night design in white
- Low installation depth, very flat design
- Clearly visible due to permanent lighting
- Two-color status indicator (red / blue for on / off)
- Low power consumption due to electronic control
- Control with thermostat function: heats immediately with 100% power
- Power at each regulator position, then constant temperature depending on the selected level

Scope of delivery for 1 seat:

Je1x carbomesh Vario 22 (22x50cm) for seat and backrest

Tensioning crosswise, 1 cable set, 1 switch round (5-stage with rotary wheel)

Installation instructions 59011 149,-

Active back cushion

- Perfect ventilation and back relief for on the go
- For healthy mobility
- Easy to attach due to practical fastening system
- Breathable 3D AirMesh cover with zipper on the side
- Washable up to 60

Back cushion with slatted spring core for more ventilation and relief. With built-in back training. Use in all touring vehicles, including seats with side airbags.

Also suitable for office chairs.

Dimensions: L: ca. 60 x W: ca. 30 cm.

Color Black.

93009 40,90



Froli

CUP-IN Cupholder for VW T5/T6 + Mercedes V-Class



The practical cup holder can be attached to various armrests in the vehicle without much effort or additional tools. This means that bottles, cups or cans are always immediately at hand. The combination of ceramic-coated metal in the color titanium matt and black polyamide gives the CUP-IN its compact and stable properties. The CUP-IN is optimal for containers with a diameter between 65 and 80 mm and a minimum height of 95 mm.

① **For wide armrests** : The cup holder is not suitable for the original armrests in the VW T5... Dimensions: 88 x 165 x 96 mm. Weight 220 g.

1 piece 46220 30,95

② **For narrow armrests**: with a minimum height of 45 mm and maximum width of 58 mm. Optimal on armrests of VW T5/T6 seats but also armrests of e.g. Mercedes Viano.

1 piece 46206 37,95



80,95

CARBEST
INNOVATIONS FOR MOBILE LIFE

Massage support

With 4 shiatsu massage heads with heat function & vibration, automatic shut off after 15 min. For massage of back and seat, can also be used as a rest on a sturdy camping chair, if access to 12 V available.

Massage seat incl. 12 V adapter, 30 Watt. 94348 80,95

Must not be used while driving!

ROTATING BRACKETS FOR VW T6.1/T6/T5

With TÜV

For original seats VW T6.1/T6/T5 (single seats) from 2003 onwards
 Driver's side 595717 266,-
 Passenger side 595716 266,-
 Handbrake adapter without leatherette cuff 595718 43,65

Without TÜV

For original seat FS/BFS >My. 2003
 If original battery is installed.
 59502 258,-
Matching handbrake lowering
 necessary for driver's side swivel console
 Left-hand drive 59616 38,20
 Right-hand drive 596160 38,20

With TÜV

Swivel bracket from My. 2003
 Installation only if there is no battery under the seat. Driver's side incl. handbrake lowering.
 59498 244,-
 Passenger side 59499 244,-
Matching handbrake lowering
 necessary for driver's side swivel console
 59616 38,20

Without TÜV

VW T5 for original double bench My. 2003-2015 Test number: 76/115/EEC. Dimensions in mm: L 605 x W 406 x H 229 (without screws)
NEW! Left-hand drive
 594962 584,-
 Rechtslenker 594961 555,-

With TÜV

VW T6.1/T6/T5 for original double seat bench from My. 2003-2015
 With parts certificate. Without cable gland.
 Left-hand drive 59496 639,-

With TÜV

VW T6.1/T6/T5 for original double seat from My. 2003
 With parts certificate. Without cable gland.
 Left-hand drive 59667 639,-

NEW 2023

Without TÜV

Seat base for Original seat from 2003
 Height adjustable: 230 - 360 mm,
 Passenger side 596501 675,-

Without TÜV

For original seat from My. 2003
 • With Safe
 Driver side/passenger side 59647 459,-
Matching handbrake lowering
 necessary with swivel console driver's side-
 Left-hand drive 596471 23,30

Without TÜV

Adapter Sportscraft seat from My. 2003
 Incl. Slide rails For mounting Sportscraft seats on original or swivel consoles.
 596451 314,-

With TÜV

For original seat FS/BFS from My. 2003
 59699 165,-
 Adapter handbrake 59697 41,90

With TÜV

Rotating base for VW T6.1/T6/T5 driver+passenger side with ABE
 Mounting also possible on vehicles with battery in the seat box. For driver's side, please also order handbrake adapter 59616.
 59653 262,-
Matching handbrake lowering
 necessary for driver's side swivel console
 59616 38,20

With TÜV

Swivel console for original seat from My. 2003
 • No increase in seat height
 • Rotation of the seat possible even with the door closed
 With mounting hardware incl. handbrake lever adapter. TÜV tested with parts certificate.
 Locking possible in direction of travel or also in 180° position. Handbrake lever can be mounted individually. External dimension: 430 x 430 x 210 mm. Weight ca. 17 kg.
 Driver's side 59593 306,-
 Passenger side 59594 285,-

With TÜV

Swivel console for VW T6.1/T6/T5
 For battery installation. Height 250 mm
 Driver side 59538 429,-
 Passenger side 59544 399,-

The TÜV can also accept your vehicle without tested individual components, please clarify details with your test center.

ROTATING BRACKETS VW/CITROËN/RENAULT/TOYOTA/OPEL

For VW T4



Swivel console for original seat
My. 1996-2003
 Driver's side 59471 187,-
 Passenger side 594711 187,-



Swivel console original seat + Sportscraft
for year 1996-2003
 Rotating in the middle, mwith cable gland
 Driver's side/passenger's side.
 59501 273,-

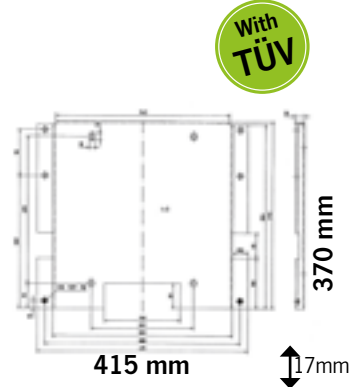

Adapter for Sportscraft seat
to swivel base 59501.
 Original rails required.
 59510 156,-

For VW T4 until 1996



Rotating console until year of
manufacture Center rotating for dri-
 ver / passenger side. Belt whip (No.
 E5487) must be ordered as well.
 59511 268,-



Belt whip for swivel bracket 59511
 Screw connection to seat box.
 E5487 51,40

For VW T3 My. 1979-1992



Swivel base for original seat For
 T3 first registration before 1.1.1992
 no TÜV necessary, from 1.1.1992 at
 least a certificate according to 76/115
 EWG (Europe-wide ECE R14) must be
 available. 59500 279,-



Adapter f. Sportscraft seat
 For T3 first registration before 1.1.1992
 no TÜV necessary, from 1.1.1992 at
 least a certificate according to 76/115
 EWG (Europe-wide ECE R14) must
 be available 59503 138,-

For Citroën Jumpy/Peugeot Expert as of 2016



Swivel bracket
for original seat
 Driver's side 595881 489,-
 Passenger side 595882 419,-
 Handbrake cover 595889 18,50

Swivel console for original seat
 Driver's side 595883 368,-
 Passenger side 595884 372,-
 Handbrake lever adapter 595885 46,50

Swivel consoles tested in conjunction with the electrically adjustable seats of:

- Toyota Proace/Proace Verso,
- Citroën Jumpy/SpaceTourer, -
- Peugeot Expert/Traveller, -
- Opel Vivaro/ Zafira Live
- Low construction
- Large cable gland
- Low weight (ca.9.4 kg)
- Assembly friendly
- Tested according to M1/N1



Driver's side 59008 328,-
 Passenger side 59009 328,-
 Handbrake lowering 59010 65,25

For Citroën Spacetourer, Jumpy/Peugeot Expert, Traveller/ Toyota ProAce II from 2016/Opel Vivaro from 2019



Swivel bracket flat
for original seat
 Driver's side 59668 349,90
 Passenger side 59669 359,90
 Handbrake cover 596681 45,90



Swivel console with elevation
for original seat
 Driver's side 59670 499,-
 Passenger side 59671 420,-
 Handbrake cover 596701 89,90

For Ford Transit/ Tourneo Custom



Swivel bracket V362
 Driver's side 59587 311,-
 Passenger side 595870 311,-



Handbrake lowering V362 for driver side
 595871 32,60

For Ford Transit

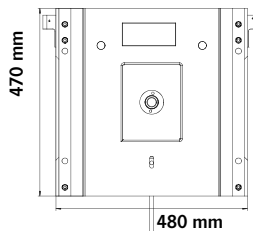

Fig. shows swivel console for driver's side

Swivel console for mounting between original seat box and Ford slide rails, My. 2004 - 2012 (Only for vehicles with handbrake left)
 Driver's side 59529 299,-
 Passenger side 595291 299,-

For original seat Ford Transit Custom and Tourneo > 2012, Ford Transit >2014



Driver's side 595711 267,-
 Beifahrerseite 595710 267,-

For original seat Ford Transit Custom and Tourneo >2012 Ford Transit >2014



Swivel bracket
 Driver side + passenger side 59672 256,-
Handbrake adapter Tourneo u. Custom incl. leatherette cuff 596722 69,90

Turntable elevation kit Tourneo & Custom from 2012 596721 49,95

For Renault Traffic >2014/ Fiat Talento 2016-2020/ Nissan NV 300 >2016/ Opel Vivaro 2014-2019



Swivel console for Renault Traffic from 2014
 Driver side 59673 256,-
 Passenger side 59674 256,-

For Renault Traffic II /Opel Vivaro A My. 2001 until 2014



For double seat
 594960 704,-



For original seat
 Driver's side 59570 279,-
 Passenger side 595701 279,-

For Renault Traffic X82, Traffic III/ Opel Vivaro B >2014 and Fiat Talento



For original seat
 Driver's side 59585 339,-
 Passenger side 59586 312,-

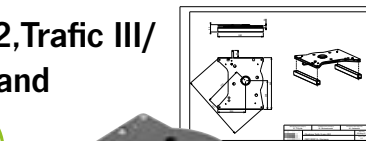

For Original seat
 Driver's side: 595714 267,-
 Passenger side: 595713 267,-
 Adapter for raising the seat console (no handbrake adapter necessary) 595715 40,50

ROTATING BRACKETS FOR MAXICAMPER

For Mercedes Vito/Viano



Without TÜV

Swivel console for Vito original seat 1996 until 2003
 Driver's side 594772 183,-
 Passenger side 594773 183,-



With TÜV

Swivel console for original seat 2004 until 2015
 Driver's side 59598 311,-
 Passenger side 59599 311,-

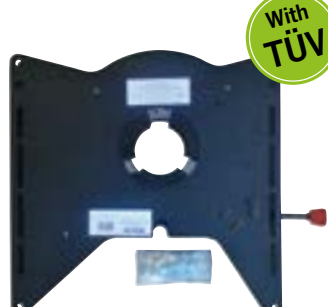

With TÜV

Swivel console for original seat >2015 + Sprinter >2019
 Driver's side 59596 311,-
 Passenger side 59597 311,-

For VW Crafter >2017

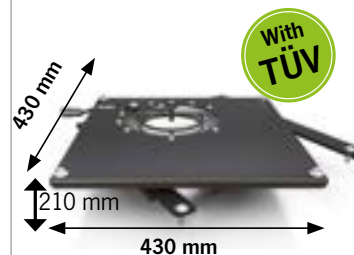

With TÜV

Swivel console for original seat
 Approval ECE-N1, no handbrake adapter necessary
 Driver side 59643 407,-
 Passenger side 59644 407,-

For Mercedes Sprinter and VW LT

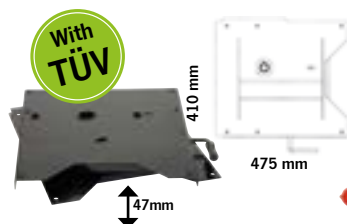

With TÜV

Swivel console for original seat My. 1996-2002
 incl. handbrake lowering
 Driver's side 59532 291,-
 Passenger side 59533 288,-

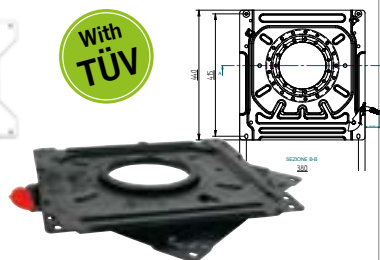

With TÜV

Swivel console for original seat My. 1995 (VW LT 1996) until 2006
 Driver's side 59476 229,-
 Passenger side 594761 229,-

For MB Sprinter >2006 and VW Crafter 2006-2016

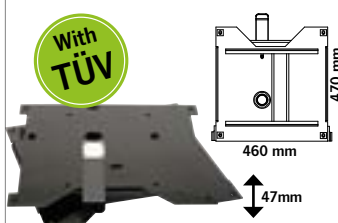

With TÜV

Rotating console for original seat driver's side incl. handbrake lowering.
 Driver's side 59633 291,-
 Passenger side 59634 289,-

For MB Sprinter >2018 and VW Crafter 2006-2016



With TÜV

Swivel console for original seat
 Tested and homologated according to R14. For driver or passenger side
 59655 305,-

For Fiat Ducato type 230 Citroen Jumper Peugeot Boxer

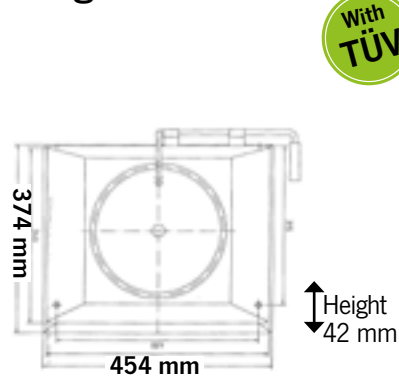

With TÜV



Art. 59547 incl. adapter

Swivel bracket My. 1995-2001
 For original driver / passenger seat.
 59546 329,-
 With adapter for Sportcraft seat driver / passenger.
 59547 359,-

For Renault Master/ Opel Movano

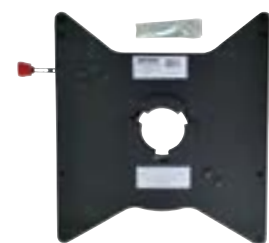

Swivel bracket >2010
 Driver's side 59588 311,-
 Passenger side 595880 311,-



With TÜV

H 25 mm

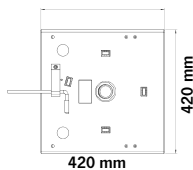

Swivel console for original seat, My. 2004-2009, driver/passenger side:
 59642 272,70

For VW Crafter/ MAN + 2017

With TÜV

(for Crafter My. 2017-2021)



For original seats
 Driver's side: 595720 267,-
 Passenger side: 595719 267,-



**For
Fiat Ducato Type 244
Citroën Jumper
Peugeot Boxer**

2002 - 2006



With TÜV

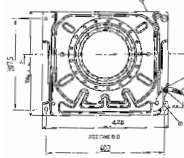

Swivel console for original seat
Driver's side 59478 169,-
Passenger side 594781 169,-



With TÜV

Swivel bracket for original seat Mounting between underframe and slide rail. Off center rotating.
Driver's side 59573 232,-
Passenger side 59574 232,-

With TÜV



Swivel console for original seat
Mounting between base frame and slide rail. Driver/passenger side, center rotating.
59572 232,-

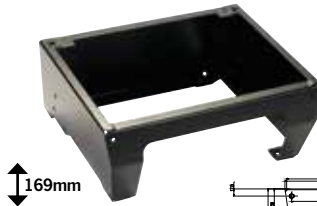

With TÜV

Seat box flat
Instead of original box.
59545 201,-

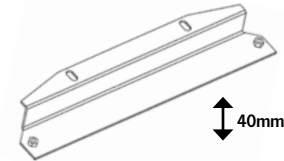

With TÜV

Flat adapter as replacement for original socket
Thus 40 mm lower seating position than with original seat box.
For passenger side 59549 63,10

**For
Fiat Ducato Type 250
Fiat Ducato Type 290
Citroën Jumper
Peugeot Boxer**

>2006



With TÜV

Swivel console for original seat
Driver's side 59473 232,-
Passenger side 594731 231,50

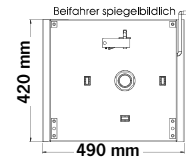

With TÜV

Swivel console for original seat
Driver + Passenger, center rotating 59581 265,-
Driver, turning off-center 59583 265,-
Passenger, rotating eccentrically 59582 265,-



With TÜV

For Sportscraft seat Mounting between base frame and slide rail.
Fs. & Bfs. center rotating 59589 472,-
Driver's side, offset rotating E4993 449,-
Passenger side, offset rotating E4863 449,-

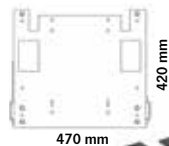

With TÜV

Standard adapter for Sportscraft seats.
59584 189,-

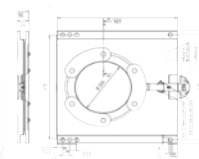

With TÜV

Swivel bracket for original seat FS/BFS
with test certificate according to e50
59698 149,-

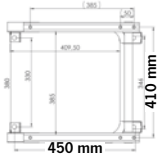

With TÜV

Low seat box
Mounting instead of the original undercarriage if there is no battery under the seat. Ideal in conjunction with swivel bracket. This base is about 40 mm flatter than the original base.
59548 243,-

**For Fiat Ducato type 250X
>07/2006**

Without TÜV



Swivel console for original seat
Driver's side 594702 173,-
Passenger side 594703 173,-